

GeneXpert® Dx System



Operator Manual

Software Version 6.2

Preface

About this Manual

The *GeneXpert[®] Dx System Operator Manual* provides instructions on how to operate the GeneXpert Dx system. The software-related instructions in this operator manual assume you have basic computer skills. You should be familiar with the Microsoft[®] Windows[®] graphical user interface. If you do not have these skills, refer to the documentation for Windows.

Safety Information

[Chapter 8, Hazards](#) in this manual provides important safety information that should be used when operating the GeneXpert Dx system. Read and understand the safety information thoroughly before beginning to operate the instrument. Using the instrument without reading the hazard chapter or without proper training can result in serious injury, damage to the instrument, invalid results, or loss of data.

Warning



A warning indicates a possibility of adverse reactions, injury, or death to the user or other personnel if the precautions or instructions are not observed.

Caution



A caution indicates that damage to the system, loss of data, or invalid results could occur if the user fails to comply with the advice given.

Important











Important indicators highlight information that is critical for the completion of a task or the optimal performance of the system.

Note

A note identifies information that applies only to specific cases or tasks.

Symbols Used in the Manual and on GeneXpert Dx System Labels

The following symbols and icons are used in this manual and on the GeneXpert Dx system labels:

Symbol	Meaning
	<i>In vitro</i> diagnostic medical device
	CE marking—European Conformity
	Do not reuse
	Consult instructions for use
	Manufacturer
	Authorized representative in the European Community
	Separate collection for electrical and electronic equipment waste per Directive 2002/96/EC in the European Union.
	This type of warning label indicates a potential biological hazard risk. Biological samples such as tissues, body fluids, and blood of humans and/or animals have the potential to transmit infectious diseases. Follow your local, state/provincial, and national safety regulations for handling and disposing the samples.
	This type of warning label indicates that hazardous high voltage sections are present in the electrical system in the GeneXpert Dx system. Do not remove covers with this warning label.
	This type of symbol indicates a possibility of loss of data or data corruption if proper procedures are not followed. Read any additional information following the symbol to avoid the data loss.
	This type of symbol indicates a Warning or Caution for which there is no other identified symbol. Read the instructions following the symbol to avoid injury or equipment damage.

Cepheid Headquarters Locations

Corporate Headquarters

Cepheid
904 Caribbean Drive
Sunnyvale, CA 94089
USA
Telephone: +1 408.541.4191
Fax: +1 408.541.4192

European Headquarters

Cepheid Europe SAS
Vira Solelh
81470 Maurens-Scopont
France
Telephone: +33 563 825 300
Fax: +33 563 825 301

Technical Assistance

Before contacting Cepheid Technical Support, collect the following information:

- Product name
- Lot number
- Serial number of the instrument
- Error messages (if any)
- Software version and, if applicable, Computer Service Tag number

Contact Information

United States

Telephone: + 1 888 838 3222
Email: techsupport@cepheid.com

France

Telephone: + 33 563 825 319
Email: support@cepheideurope.com

Contact information for all Cepheid Technical Support offices is available on our website: www.cepheid.com/en/CustomerSupport.



Cepheid
904 Caribbean Drive
Sunnyvale, CA 94089
USA
Telephone: +1.408.541.4191
Fax: +1.408.541.4192



Cepheid Europe SAS
Vira Solelh
81470 Maurens-Scopont
France
Telephone: +33 563 825 300
Fax: +33 563 825 301
www.cepheidinternational.com

Warranty

The following information constitutes the Product-specific warranties referenced in the purchase agreement (typically bearing a title such as “Purchase Agreement” or “Sales Agreement”) under which the GeneXpert[®] Instrument and Software described herein were purchased from Cepheid[®].

Purchaser must not alter or remove any labels, signs, symbols, serial numbers, copyright, patent, trademark, trade secret, proprietary and/or other legal notices contained on or in this Manual, the GeneXpert Instrument, GeneXpert Software, and related documentation.

GeneXpert Instrument Limited Warranty

Cepheid warrants that (i) the GeneXpert Instrument (the “Instrument”) is free from defects in material and workmanship, (ii) the Instrument together with the GeneXpert Dx System Software (the “Product”) conforms to Cepheid's published specifications, and (iii) the Product conforms to the labeling claims that accompany the Instrument. This Warranty is for a period of 12 months from the date of shipment to the Purchaser (the Warranty Period). During the Warranty Period, if the Instrument's hardware is found to be defective or if the Product is found to be non-conforming under item (ii) or (iii) above, Cepheid will repair or replace it, at a site determined by Cepheid at Cepheids expense. This warranty extends to Purchaser only and not to any other parties, except as agreed to in writing by Cepheid, and applies only to new products manufactured by Cepheid.

Cepheid does not warrant any defects in the Instrument caused by (i) improper installation, removal or testing, (ii) Purchaser's failure to provide a suitable operating environment for the Instrument, (iii) use of the Instrument for purposes other than that for which it was designed, (iv) unauthorized attachments, (v) unusual physical or electrical stress, (vi) modifications or repairs done by other than Cepheid or a Cepheid authorized service provider, or (vii) any other abuse, misuse, or neglect of the Instrument. The Instrument is designed and certified with applicable regulatory authorities as part of an integrated instrument/reagent/consumable system. Use of unapproved parts, reagents or other materials with the Instrument will void any warranty and any service contract between Cepheid and the Purchaser that pertains to the Instrument.

OTHER THAN ANY EXPRESS WARRANTY PROVIDED IN THE ORIGINAL PURCHASE AGREEMENT WITH CEPHEID, THERE ARE NO WARRANTIES WHICH EXTEND BEYOND THE FACE HEREOF, AND CEPHEID DISCLAIMS ALL OTHER REPRESENTATIONS AND WARRANTIES, WHETHER EXPRESS OR IMPLIED, REGARDING THE PRODUCT, INCLUDING ANY IMPLIED WARRANTIES OF MERCHANTABILITY OR FITNESS FOR A PARTICULAR PURPOSE. CEPHEID AND ITS DIRECTORS, OFFICERS, EMPLOYEES AND AGENTS SHALL HAVE NO LIABILITY FOR GENERAL, CONSEQUENTIAL, INCIDENTAL OR SPECIAL DAMAGES ARISING FROM A DEFECT IN THE INSTRUMENT. FURTHERMORE, CEPHEID SHALL HAVE NO STRICT LIABILITY, PRODUCTS LIABILITY OR NEGLIGENCE LIABILITY, WHETHER ACTIVE OR PASSIVE, AS TO THE PURCHASER.

Purchaser's exclusive remedy for any defective Instrument or non-conforming Product is limited to the repair or replacement of any defective Instrument. If Cepheid cannot or does not repair or replace a defective Instrument or non-conforming Product, Cepheid will remove same and return the purchase price. If Cepheid cannot or does not repair or replace any defective Instrument or non-conforming Product or if Purchaser's exclusive remedy fails of its essential purpose, Cepheid's entire liability shall in no event exceed the purchase price for any defective Instrument or non-conforming Product.

Cepheid GeneXpert Dx System Software License Agreement

Cepheid is the exclusive owner of the Cepheid GeneXpert Dx System Software program (the "Software"), related documentation and physical media, and of all copyright, trade secret, patent, trademark and other intellectual or industrial property rights therein. Physical media and copies of the Software, whether in diskette, tape, paper or other form, shall remain the property of Cepheid, and such copies are deemed to be on loan to Purchaser during the term of the License granted hereby. Purchaser expressly acknowledges that no title to or ownership of the Software, or any copy or portion thereof, is transferred to Purchaser. The ideas and expressions thereof contained in the Software are confidential, proprietary information and trade secrets of Cepheid that are provided to Purchaser. Purchaser shall not cause or permit decompilation, disassembly, or reverse engineering of the Software or disclosure, copying, display, loan, publication, transfer of possession (whether by sales, exchange, gift, operation of law or otherwise) or other dissemination of the Software and related documentation, in whole or part, to any third party without the prior written consent of Cepheid.

License Grant: Cepheid grants Purchaser a non-exclusive, non-transferable license (the "License") to use only one (1) copy of the Software on the computer provided by Cepheid with the GeneXpert Instrument(s) and connected to the GeneXpert Instrument(s), and to make only one (1) copy solely for back-up purposes. Purchaser shall not otherwise copy and shall not modify, duplicate, translate, disassemble, or decompile the Software without Cepheid's prior written consent. If the Software is used on a computer other than the one provided by Cepheid for the GeneXpert Instrument, Cepheid will not guarantee performance and cannot provide technical support for problems arising therefrom. Purchaser may not use this single-user product on a network. This License entitles Purchaser to use toll-free telephone support as provided by Cepheid. This License is effective until terminated. Cepheid may terminate this License if Purchaser fails to comply with any of the terms or conditions of this License or of the original purchase agreement. If this License is terminated, Purchaser must destroy all copies of the Software and its related documentation.

For Government Purchasers, the Software is commercial computer software subject to restricted rights under FAR 52.227-19 (C) (1, 2).

The end user license agreement is located at C:\program files\cepheid\genexpert 4.0\resources\en_us\files\DxLicenseAgreement.pdf.

For software version 4.4 and earlier, if you cannot locate your license, you may obtain a copy from Cepheid Technical Support.

Trademark and Copyright Statements

Cepheid[®], the Cepheid logo, GeneXpert[®] and I-CORE[®] are trademarks of Cepheid.

Adobe[®] and Acrobat[®] are registered trademarks of Adobe Systems Incorporated.

Ethernet[®] is a registered trademark of Xerox Corporation.

Microsoft[®] and Windows[®] are registered trademarks of Microsoft Corporation.

All other trademarks are the property of their respective owners.

This Manual contains information protected by copyright. No part of this Manual may be photocopied or reproduced in any form without prior written consent from Cepheid.

© Cepheid 2020 — All rights reserved.

Disclaimers

All examples (printouts, graphics, displays, screens, etc.) are for information and illustration purposes only and shall not be used for clinical or maintenance evaluations. Data shown in sample printouts and screens do not reflect actual patient names or test results. Labels depicted in the manual may appear different from actual product labels. Cepheid makes no representations or warranties about the accuracy and reliability of the information contained in the *GeneXpert Dx System Operator Manual*. The information was developed to be used by persons trained and knowledgeable in GeneXpert operation or under the direct supervision of Cepheid Technical Support or service representatives. Updates to this Operator Manual may be issued periodically and should be maintained with this original manual.

Not all products described in this Manual are available in all countries.

Warning



This product can expose you to chemicals, including nickel (metallic), which is known to the State of California to cause cancer. For more information, go to <https://www.P65Warnings.ca.gov>.

Table of Contents

1	Introduction—Use or Function	1-1
1.1	Intended Use	1-2
1.2	Terms Used for System Descriptions	1-2
1.3	Models of GeneXpert Instruments	1-2
1.4	6-Color and 10-Color Modules	1-3
1.5	System Components	1-3
1.5.1	GeneXpert Dx System Components	1-4
1.6	GeneXpert Cartridges	1-8
1.7	GeneXpert Dx Software	1-9
1.8	Workflow Overview	1-10
1.8.1	Installation and Setup Workflow	1-10
1.8.2	Test Workflow	1-11
1.9	Before Operating the Instrument	1-12
2	Installation Procedures and Special Requirements	2-1
2.1	GeneXpert Dx System Package Contents	2-2
2.2	Required Materials for Use with the System (But Not Provided)	2-2
2.3	Recommended Materials for Use with the System	2-2
2.4	System Notes	2-3
2.4.1	System Components	2-3
2.4.2	Network Connection	2-3
2.4.3	Software Media	2-3
2.5	Installing the GeneXpert Dx System	2-4
2.5.1	To Install a GeneXpert Dx System	2-4
2.5.2	To Install Additional Instruments	2-9
2.5.3	Connecting to Cepheid C360	2-11
2.6	Turning On the Computer	2-13
2.6.1	Anti-Virus Software	2-17
2.6.1.1	Windows 7 Anti-Virus Software	2-17
2.6.1.2	Windows 10 Anti-Virus Software	2-18
2.7	Disk Encryption (Windows 10)	2-18
2.8	Windows Language and Keyboard Configuration	2-20
2.9	Configuring the Computer	2-20
2.9.1	Power Management Settings	2-20
2.9.1.1	Selecting the Power Management Settings on Windows 7	2-20
2.9.1.2	Selecting the Power Management Settings on Windows 10	2-25

Table of Contents

2.9.2	Local Date and Time	2-29
2.9.2.1	Setting the Local Date and Time on Windows 7	2-29
2.9.2.2	Setting the Local Date and Time on Windows 10	2-31
2.9.3	IP Address	2-33
2.9.3.1	Setting the IP Address on Windows 7	2-33
2.9.3.2	Setting the IP Address on Windows 10	2-37
2.10	Controlling Windows 10 Automatic Updates	2-41
2.11	Starting the Software for the First Time	2-42
2.12	Assigning Instrument Letters	2-44
2.12.1	To Assign Instrument Letters (GX-I, GX-II and GX-IV Instruments)	2-44
2.12.2	To Assign Instrument Letters (GX-XVI Instruments)	2-50
2.13	Defining Users and Permissions	2-55
2.13.1	User Types	2-56
2.13.2	Specifying User Permissions	2-56
2.13.3	Managing Users	2-58
2.13.3.1	Adding New Users	2-58
2.13.3.2	Editing User Profiles	2-59
2.13.3.3	Removing Users	2-60
2.14	Configuring the System	2-62
2.14.1	General Tab	2-62
2.14.2	Archive Settings Tab	2-65
2.14.3	Folders Tab	2-67
2.14.4	Host Communication Settings Tab	2-68
2.14.4.1	Configuring Host Communications for an LIS	2-68
2.14.4.2	Configuring Host Communications for Cepheid Link	2-71
2.14.5	Configuring Assay for Order and Result Upload	2-73
2.14.5.1	Configuring a Single-Result Assay for Order and Result Upload	2-74
2.14.5.2	Configuring a Multiple-Result Assay for Order and Result Upload	2-74
2.15	Verifying Proper Installation and Setup	2-75
2.16	Managing Assay Definitions and Lot Specific Parameters	2-79
2.16.1	Connecting and Using the DVD Drive	2-79
2.16.1.1	Connecting an External DVD Drive to the GX Dx System	2-79
2.16.1.2	Using the Internal DVD Drive in the GX Dx System	2-80
2.16.2	Importing Assay Definitions	2-80
2.16.3	Deleting Assay Definitions	2-83
2.16.4	Importing Lot Specific Parameters Manually	2-84
2.16.5	Deleting Lot Specific Parameters	2-86
2.17	Restarting the System	2-87

2.17.1	Shutting the System Down	2-87
2.17.1.1	Archive Overdue Reminder	2-87
2.17.1.2	Database Management Reminder	2-88
2.17.1.3	Final Shutdown Steps	2-89
2.17.2	Restart the System	2-90
2.18	Uninstalling or Reinstalling GeneXpert Dx Software	2-90
3	Principles of Operation	3-1
3.1	System Operation Overview	3-1
3.2	GeneXpert Module	3-3
3.3	GeneXpert Cartridge	3-3
3.4	I-CORE Module	3-5
3.5	Heating and Cooling Mechanisms	3-6
3.6	Explanation of Experimental Methods	3-6
3.7	Optical System	3-7
3.7.1	Six-Color Modules	3-7
3.7.2	Ten-Color Modules	3-8
3.8	System Calibration	3-9
4	Performance Characteristics and Specifications	4-1
4.1	Instrument Classification	4-1
4.2	General Specifications	4-2
4.2.1	General Specifications for GeneXpert R1 Instruments	4-2
4.2.2	General Specifications for GeneXpert R2 Instruments	4-3
4.3	Operational Environmental Parameters	4-4
4.4	Environmental Conditions—Storage and Transport	4-4
4.5	Sound Pressure	4-4
4.6	European Union Directives	4-5
4.7	Table of Hazardous Substance’s Names and Concentrations	4-5
4.8	Product Energy Consumption Information	4-5
4.9	Heat Output	4-6
5	Operating Instructions	5-1
5.1	Typical Workflow	5-2
5.2	Getting Started	5-3
5.2.1	Powering the Instrument On and Off	5-3
5.2.2	Turning On The Computer	5-3
5.2.3	Starting the Software	5-6
5.2.3.1	Database Management Reminder	5-9
5.2.3.2	Archive Overdue Reminder	5-10

Table of Contents

5.2.4	Logging On with Software Running	5-12
5.2.5	Logging Off	5-13
5.2.6	Changing Your Password	5-14
5.3	Using the System Window	5-16
5.4	Checking the List of Available Assay Definitions	5-17
5.5	Barcode Scanner Usage	5-18
5.6	Creating a Test	5-19
5.7	Loading a Cartridge into an Instrument Module	5-26
5.8	Starting the Test	5-27
5.9	Monitoring the Test Process	5-29
5.10	Stopping a Test in Progress	5-30
5.11	Viewing the Test Results	5-31
5.11.1	Displaying the Test Results	5-31
5.11.2	Basic User View	5-33
5.11.2.1	Results Tab	5-33
5.11.2.2	Errors Tab	5-35
5.11.2.3	Support Tab	5-36
5.11.3	Detail User and Administrator View	5-37
5.11.3.1	Test Result Tab	5-38
5.11.3.2	Analyte Result Tab	5-39
5.11.3.3	Detail Tab	5-41
5.11.3.4	Errors Tab	5-43
5.11.3.5	History Tab	5-44
5.11.3.6	Support Tab	5-45
5.12	Editing the Test Information	5-46
5.13	Generating Test Result Reports	5-50
5.13.1	Test Result Reports for Basic Users	5-50
5.13.2	Test Result Reports for Detail and Administrator Users	5-54
5.14	Exporting the Test Results	5-59
5.15	Uploading Test Results to the Host	5-65
5.16	Managing the Test Results Data	5-66
5.16.1	Archiving the Tests	5-66
5.16.2	Retrieving Data from an Archive File	5-69
5.17	Performing Database Management Tasks	5-70
5.17.1	Backing up the Database	5-71
5.17.2	Restoring the Database	5-73
5.17.3	Compacting the Database	5-76
5.18	Purging Tests from the Database	5-77
5.19	Viewing and Printing Reports	5-77

5.19.1	Specimen Report	5-78
5.19.2	Patient Report (If Enabled)	5-81
5.19.3	Control Trend Report	5-83
5.19.4	System Log	5-83
5.19.5	Assay Statistics Report	5-83
5.19.6	Installation Qualification	5-86
5.20	Operating with Host Connectivity	5-86
5.20.1	Creating a Test with Host Connectivity	5-86
5.20.1.1	Creating a Test by Selecting from a List of Test Orders Downloaded by the Host Automatically	5-88
5.20.1.2	Creating a Test by Manually Requesting Test Orders and Selecting From the List of Test Orders	5-89
5.20.1.3	Creating a Test by Querying the Host with Sample ID	5-90
5.20.1.4	Aborting a Query	5-91
5.20.1.5	Deleting a Host Downloaded Test Order	5-92
5.20.2	Uploading a Test Result to the Host	5-93
5.20.2.1	Automatically Uploading the Test Result to the Host	5-93
5.20.2.2	Manually Uploading a Test Result to the Host	5-95
5.20.2.3	Uploading an External Control Result to the Host	5-96
5.20.3	Troubleshooting Host Connectivity	5-96
5.21	Operating with Cepheid Link Connectivity	5-97
5.21.1	Scanning a Sample and Cartridge using Cepheid Link	5-97
5.21.2	Running Cartridges Scanned from Cepheid Link	5-106
5.22	System Information	5-111
6	Calibration Procedures	6-1
6.1	Calibration	6-1
6.2	Quality Control	6-1
6.3	External Quality Controls	6-2
6.4	Qualitative Assays vs. Quantitative Assays	6-2
6.5	Control Trend Reports	6-2
7	Operational Precautions and Limitations	7-1
7.1	Security Precautions	7-1
7.2	Laboratory	7-1
7.3	Instrument and Software	7-2
7.4	Assay	7-2
7.5	Cartridge	7-2
8	Hazards	8-1
8.1	General Safety Precautions	8-1

Table of Contents

8.2	Precautionary Statements Used in this Manual	8-1
8.3	Moving the Instrument	8-3
8.4	Safety Labels on the Instrument	8-3
8.5	Laser Safety	8-4
8.6	Electrical Safety	8-4
8.7	Chemical Safety	8-4
8.8	Biological Hazard Safety	8-5
8.9	Environmental Data	8-5
9	Service and Maintenance	9-1
9.1	Maintenance Tasks	9-2
9.2	Maintenance Log	9-2
9.3	Power Down the System	9-4
9.4	Guidelines for Cleaning and Disinfecting	9-4
9.5	Cleaning the Work Area	9-5
9.6	Close Module Doors	9-5
9.7	Discard Used Cartridges	9-5
9.8	Cleaning the Instrument Surfaces	9-5
9.8.1	Quarterly Maintenance	9-6
9.8.2	In Case of Spill	9-7
9.9	Cleaning the Plunger Rods and Cartridge Bays	9-7
9.10	Cleaning the I-CORE	9-11
9.10.1	Lens Cleaning Procedure	9-12
9.11	Cleaning and Replacing the Fan Filters	9-14
9.11.1	GX-II and GX-IV Fan Filters	9-14
9.11.2	User-Serviceable GX-II and GX-IV Fan Filters	9-14
9.11.3	GeneXpert GX-XVI Fan Filters	9-18
9.11.3.1	Procedure to Clean and Replace GX-XVI R1 Fan Filters	9-18
9.11.3.2	Procedure to Clean and Replace GX-XVI R2 Fan Filters	9-21
9.11.4	High Efficiency (HE) Filter Replacement Instructions	9-24
9.12	Annual Instrument Maintenance	9-28
9.13	Using Module Reporters	9-29
9.14	Performing a Manual Self-Test	9-29
9.15	Excluding Modules from Test	9-31
9.16	Generating the System Log Report	9-33
9.17	Replacing Instrument Parts	9-36
9.18	Repairing the Instrument	9-36
9.19	Troubleshooting	9-37
9.19.1	Hardware Problems	9-37

9.19.2	Error Messages	9-38
9.19.2.1	Run-Time Errors	9-41
9.19.2.2	Operation Terminated Errors	9-43
9.19.2.3	Cartridge Loading Errors	9-47
9.19.2.4	Self-Test Errors	9-48
9.19.2.5	Post-Run Analysis Errors	9-51
9.19.2.6	Communication Loss/Recovery Errors	9-55
9.19.3	Troubleshooting Host Connectivity	9-56
9.19.3.1	Host Connectivity Indicator	9-56
9.19.3.2	Host Communication Buffer	9-57
9.19.4	Troubleshooting the LIS Interface	9-57
A	Quick Reference	A-1
B	Glossary	B-1
C	GeneXpert Dx Software International Configuration Instructions	C-1
C.1	Introduction	C-1
C.2	Summary	C-1
C.3	Before You Begin	C-1
C.4	Windows Configuration	C-2
C.4.1	Language Setting	C-2
C.4.1.1	Configuring the Windows 7 Language Setting	C-2
C.4.1.2	Configuring the Windows 10 Language Setting	C-5
C.4.2	Keyboard	C-6
C.4.3	Welcome Screen Keyboard Layout	C-10
C.4.4	Login Screen	C-14
C.4.4.1	Windows 7 Login Screen	C-14
C.4.4.2	Windows 10 Login Screen	C-15
C.5	Configuring and Testing the Barcode Scanner	C-17
C.5.1	Configuring the Symbol Model DS6708 Scanner	C-17
C.5.2	Configuring the Zebra Model DS4308-HC Scanner	C-18
C.5.3	Testing the Configuration	C-19
C.6	Date and Time Format	C-22
D	Apache OpenOffice (AOO) Initial Configuration Instructions	D-1
D.1	Introduction	D-1
D.2	Configuration	D-1

List of Figures

Figure 1-1	GX-IV Instruments, showing 6- and 10-Color Modules	1-3
Figure 1-2	GeneXpert GX-I Hardware Components (Shown with the Laptop Computer)	1-4
Figure 1-3	GeneXpert GX-I Hardware Components (Shown with the Desktop Computer)	1-5
Figure 1-4	GeneXpert GX-II Hardware Components (Shown with the Laptop Computer)	1-5
Figure 1-5	GeneXpert GX-II Hardware Components (Shown with the Desktop Computer)	1-6
Figure 1-6	GeneXpert GX-IV Hardware Components (Shown with the Laptop Computer)	1-6
Figure 1-7	GeneXpert GX-IV Hardware Components (Shown with the Desktop Computer)	1-7
Figure 1-8	GeneXpert GX-XVI Hardware Components (Shown with the Laptop Computer)	1-7
Figure 1-9	GeneXpert GX-XVI Hardware Components (Shown with the Desktop Computer)	1-8
Figure 1-10	GeneXpert Cartridge	1-8
Figure 1-11	The GeneXpert Dx Software Features	1-9
Figure 1-12	GeneXpert Dx System Window and the Typical Test Workflow	1-12
Figure 2-1	Connecting the GX-I Instrument to the Desktop Computer	2-5
Figure 2-2	Connecting the GX-II Instrument to the Desktop Computer	2-6
Figure 2-3	Connecting the GX-IV Instrument to the Desktop Computer	2-6
Figure 2-4	Connecting the GX-XVI Instrument to the Desktop Computer	2-7
Figure 2-5	Connecting the GX-I Instrument to the Laptop Computer	2-7
Figure 2-6	Connecting the GX-II Instrument to the Laptop Computer	2-8
Figure 2-7	Connecting the GX-IV Instrument to the Laptop Computer	2-8
Figure 2-8	Connecting the GX-XVI Instrument to the Laptop Computer	2-9
Figure 2-9	Connecting Multiple GX-IV Instruments to the Desktop Computer	2-10
Figure 2-10	Connecting Multiple GX-IV Instruments to the Laptop Computer	2-11
Figure 2-11	Connecting GX-IV Instrument to C360	2-12
Figure 2-12	Connecting Multiple GX-IV Instruments to C360	2-12
Figure 2-13	Windows 7 Account Screen	2-14
Figure 2-14	Windows 10 Lock Screen	2-14
Figure 2-15	Windows 7 Password Screen	2-15
Figure 2-16	Windows 10 Account and Password Screen	2-16
Figure 2-17	GeneXpert Dx System Shortcut Icon	2-16
Figure 2-18	All Control Panel Items Window	2-21
Figure 2-19	Power Options Window	2-21
Figure 2-20	Edit Plan Settings Window	2-22
Figure 2-21	Power Options—Advanced settings Window	2-22

List of Figures

Figure 2-22	Power Options Window	2-23
Figure 2-23	System Settings Window	2-24
Figure 2-24	All Control Panel Items Window	2-25
Figure 2-25	Power Options Window	2-25
Figure 2-26	Edit Plan Settings Window	2-26
Figure 2-27	Power Options—Advanced settings Window (Sleep)	2-26
Figure 2-28	Power Options—Advanced settings Window (Display)	2-27
Figure 2-29	Power Options Window	2-28
Figure 2-30	System Settings Window	2-28
Figure 2-31	Date and Time Properties Dialog Box	2-29
Figure 2-32	Date and Time Settings Dialog Box	2-30
Figure 2-33	Time Zone Settings Dialog Box	2-30
Figure 2-34	Date and Time Properties Dialog Box	2-31
Figure 2-35	Date and Time Settings Dialog Box	2-32
Figure 2-36	Time Zone Settings Dialog Box	2-32
Figure 2-37	All Control Panel Items Window—Category View	2-33
Figure 2-38	Network and Sharing Center Screen	2-34
Figure 2-39	Network Connections Screen	2-34
Figure 2-40	Network Connections Screen with Drop-Down Menu	2-35
Figure 2-41	GeneXpert Connection Properties Screen	2-35
Figure 2-42	GeneXpert Connection Properties Screen	2-36
Figure 2-43	Internet Protocol Version 4 (TCP/IPv4) Properties Screen	2-36
Figure 2-44	All Control Panel Items Window—Category View	2-37
Figure 2-45	Network and Sharing Center Screen	2-38
Figure 2-46	Network Connections Screen	2-38
Figure 2-47	Network Connections Screen with Drop-Down Menu	2-39
Figure 2-48	GeneXpert Connection Properties Screen	2-39
Figure 2-49	Internet Protocol Version 4 (TCP/IPv4) Properties Screen	2-40
Figure 2-50	GeneXpert Dx System Shortcut Icon	2-43
Figure 2-51	GeneXpert Dx System Window	2-43
Figure 2-52	GeneXpert Dx System Window with Assign Instrument Letter Dialog Box Overlay	2-44
Figure 2-53	GeneXpert Dx System Window with Database Management Dialog Box Overlay	2-45
Figure 2-54	GeneXpert Dx System Window with Test Archive Reminder Dialog Box Overlay	2-46
Figure 2-55	GeneXpert Dx System Window	2-46
Figure 2-56	GeneXpert Dx System Window, showing the Setup Drop-Down Menu	2-47

Figure 2-57	GeneXpert Dx System Window with Assign Instrument Letter Dialog Box Overlay	2-47
Figure 2-58	GeneXpert Dx System Window with Change Letter Dialog Box Overlay	2-48
Figure 2-59	GeneXpert Dx System Window with Assign Instrument Letter Dialog Box Overlay	2-48
Figure 2-60	GeneXpert Dx System Window with Updated Instrument Letter Assignments	2-49
Figure 2-61	GeneXpert Dx System Window at System Restart	2-49
Figure 2-62	Quadrant Assigned Letters (GX-XVI Shown)	2-50
Figure 2-63	GeneXpert Dx System Window with Assign Instrument Letter Dialog Box Overlay	2-51
Figure 2-64	GeneXpert Dx System Window with Database Management Dialog Box Overlay	2-52
Figure 2-65	GeneXpert Dx System Window	2-52
Figure 2-66	GeneXpert Dx System Window showing Setup Drop-Down Menu	2-53
Figure 2-67	GeneXpert Dx System Window with Assign Instrument Letter Dialog Box Overlay	2-53
Figure 2-68	GeneXpert Dx GeneXpert Dx System Window with Change Letter Dialog Box Overlay	2-54
Figure 2-69	GeneXpert Dx System Window showing New Module Letter Assignments	2-55
Figure 2-70	User Administration Dialog Box	2-58
Figure 2-71	Add User Dialog Box	2-59
Figure 2-72	Edit User Dialog Box	2-60
Figure 2-73	User Administration Dialog Box	2-60
Figure 2-74	User Administration Dialog Box selecting User to be Removed	2-61
Figure 2-75	User Admin Dialog Box after User Removal	2-61
Figure 2-76	System Configuration Dialog Box (General Tab)	2-63
Figure 2-77	System Configuration Dialog Box (Archive Settings Tab)	2-66
Figure 2-78	System Configuration Dialog Box (Folders Tab)	2-67
Figure 2-79	System Configuration Dialog Box (Host Communication Settings Tab)	2-68
Figure 2-80	Host Communication Settings Workspace Configured for Cepheid Link	2-72
Figure 2-81	Define Test Code Dialog Box for a Single-Result Assay	2-74
Figure 2-82	Define Test Code Dialog Box for a Multi-Result Assay	2-75
Figure 2-83	GeneXpert Dx System Window showing Reports Drop-Down Menu and Installation Qualification Selection	2-76
Figure 2-84	Example Installation Qualification Report—Page 1	2-77
Figure 2-85	Example Installation Qualification Report—Page 2	2-78
Figure 2-86	System—Define Assays Window (Detail User View)	2-81
Figure 2-87	Import Assay Dialog Box	2-81
Figure 2-88	GeneXpert Dx System—Define Assays Window (Administrator User View)	2-83
Figure 2-89	Define Assays Window, showing Need Lot Specific Parameters Box Checked	2-84
Figure 2-90	Reagent Lot Specific Parameters Dialog Box	2-85

List of Figures

Figure 2-91	Import Reagent Lot Specific Parameters Dialog Box	2-86
Figure 2-92	Test Archive Reminder Dialog Box	2-87
Figure 2-93	Select Test(s) To Be Archived Screen	2-88
Figure 2-94	Database Management Dialog Box	2-89
Figure 2-95	Database Management Dialog Box	2-89
Figure 3-1	Example PCR Cycle Diagram for I-CORE Module Heating and Fan Cooling (Temperature Durations not to Scale).	3-2
Figure 3-2	GeneXpert Cartridge Components.	3-4
Figure 3-3	I-CORE Module (6-Color Module Shown)	3-5
Figure 3-4	Amplification Curve and Cycle Threshold (Ct)	3-7
Figure 5-1	Windows 7 Account Screen	5-4
Figure 5-2	Windows 10 Lock Screen.	5-4
Figure 5-3	Windows 7 Password Screen	5-5
Figure 5-4	Windows 10 Account and Password Screen	5-6
Figure 5-5	GeneXpert Dx System Shortcut Icon	5-6
Figure 5-6	Login Dialog Box	5-7
Figure 5-7	GeneXpert Dx System Window	5-8
Figure 5-8	Database Management Dialog Box	5-9
Figure 5-9	Database Management Dialog Box	5-9
Figure 5-10	Test Archive Reminder Dialog Box	5-10
Figure 5-11	Select Test(s) To Be Archived Screen.	5-11
Figure 5-12	User Menu (Login)	5-12
Figure 5-13	User Menu (Logout)	5-13
Figure 5-14	User Menu (Change Password).	5-14
Figure 5-15	Change Password Dialog Box	5-15
Figure 5-16	GeneXpert Dx System Window	5-16
Figure 5-17	GeneXpert Dx System—Define Assays Window	5-17
Figure 5-18	Scanning a Cartridge Barcode.	5-18
Figure 5-19	Create Test Window and Scan Patient ID Barcode Dialog Box.	5-20
Figure 5-20	Create Test Window and Scan Sample ID Barcode Dialog Box	5-20
Figure 5-21	Scan Cartridge Barcode Dialog Box	5-21
Figure 5-22	GeneXpert Cartridge	5-22
Figure 5-23	Create Test Dialog Box with the Patient ID and Sample ID Fields Shown	5-23
Figure 5-24	Create Test Dialog Box with the Date of Birth Field and Calendar Shown	5-24
Figure 5-25	Create Test Dialog Box with the Ethnicity Field Shown	5-24
Figure 5-26	Create Test Dialog Box with the Gender Field Shown.	5-25

Figure 5-27	Cartridge Showing Body and Reaction Tube	5-26
Figure 5-28	Create Test Dialog Box, Ready to Start Test.	5-27
Figure 5-29	GeneXpert Cartridge, Positioned at the Heel of the Module Bay Floor	5-28
Figure 5-30	GeneXpert Dx System Window, Displaying the Status of a Run in Progress	5-29
Figure 5-31	Stop Test Dialog Box.	5-30
Figure 5-32	GeneXpert Dx View Results Window (Detail and Administrator View)	5-32
Figure 5-33	Select Test to be Viewed Dialog Box	5-32
Figure 5-34	GeneXpert Dx View Results Window—Results Tab (Basic Users View)	5-33
Figure 5-35	GeneXpert Dx View Results Window—Errors Tab (Basic Users View)	5-35
Figure 5-36	GeneXpert Dx View Results Window—Support Tab (Basic Users View)	5-36
Figure 5-37	GeneXpert Dx View Results Window—Test Result Tab (Detail Users and Administrator View)	5-38
Figure 5-38	GeneXpert Dx View Results Window—Analyte Result Tab (Detail Users and Administrator View)	5-39
Figure 5-39	GeneXpert Dx View Results Window—Detail Tab (Detail Users and Administrator View)	5-41
Figure 5-40	GeneXpert Dx System—View Results Window—Errors Tab (Detail Users and Administrator View)	5-43
Figure 5-41	GeneXpert Dx View Results Window—History Tab (Detail Users and Administrator View)	5-44
Figure 5-42	GeneXpert Dx View Results Window—Support Tab (Detail Users and Administrator View)	5-45
Figure 5-43	GeneXpert Dx View Results Window (Detail Users and Administrator View)	5-47
Figure 5-44	GeneXpert Dx System, View Results Window (Detail Users and Administrator View)	5-47
Figure 5-45	GeneXpert Dx View Results Window, History Tab Selected	5-48
Figure 5-46	GeneXpert Dx View Results Window—Test Type Changed	5-48
Figure 5-47	Save Dialog Box	5-49
Figure 5-48	History Tab showing Change from Specimen to Negative Control Test Type.	5-49
Figure 5-49	Select Test to Be Viewed Dialog	5-51
Figure 5-50	Select Report to Generate PDF.	5-51
Figure 5-51	Basic Report Opened in Adobe Acrobat	5-52
Figure 5-52	Example Test Report—Basic User	5-53
Figure 5-53	Select Test to Be Viewed Dialog	5-54
Figure 5-54	Select Analyte Result Dialog Box	5-55
Figure 5-55	Example Test Report—Detail and Administration User Page 1	5-57
Figure 5-56	Example Test Report—Detail and Administration User Page 2	5-58
Figure 5-57	Export Data Dialog Box (Detail Users and Administrator Only).	5-59

List of Figures

Figure 5-58	Result Export Dialog Box	5-60
Figure 5-59	Opening a .csv File to Configure AOO (Example)	5-61
Figure 5-60	Text Import Screen with New Settings Selected	5-62
Figure 5-61	All Cells Selected	5-62
Figure 5-62	Drop-Down Menu to select Column Width	5-63
Figure 5-63	Column Width Dialog Box	5-63
Figure 5-64	Example Exported Test Results	5-64
Figure 5-65	Upload Test Results to the Host	5-65
Figure 5-66	Select Test(s) To Be Archived Dialog Box	5-67
Figure 5-67	Select Test(s) to Be Retrieved Dialog Box	5-69
Figure 5-68	Database Management Dialog Box	5-71
Figure 5-69	Database Management Window	5-71
Figure 5-70	Backup File Naming	5-72
Figure 5-71	Backup Completed Screen	5-72
Figure 5-72	Database Management Window	5-73
Figure 5-73	Database Restore Dialog Box	5-73
Figure 5-74	Database Backup Dialog Box	5-74
Figure 5-75	Backup Completed Screen	5-74
Figure 5-76	Select File to Restore the Database Screen, with Filename	5-75
Figure 5-77	Database Restore Confirmation Dialog Box	5-75
Figure 5-78	Database Restore Completed Confirmation Screen	5-76
Figure 5-79	Compact Database Confirmation Dialog Box	5-76
Figure 5-80	Compact Database Completed Dialog Box	5-76
Figure 5-81	GeneXpert Dx System Window—Reports Drop-Down Menu	5-78
Figure 5-82	Specimen Report Dialog Box	5-79
Figure 5-83	Example Specimen Report	5-80
Figure 5-84	Patient Report Dialog Box	5-81
Figure 5-85	Example Patient Report	5-82
Figure 5-86	Assay Statistics Report Dialog Box	5-83
Figure 5-87	Example Assay Statistics Report	5-85
Figure 5-88	Create Test Window with Host Test Order Table	5-87
Figure 5-89	Automatic Test Order Download Selected	5-88
Figure 5-90	Menu Bar Indicating Plus Sign on Create Test Button	5-89
Figure 5-91	Select Host Query	5-90
Figure 5-92	Create Test Window showing the Abort Query Button	5-91

Figure 5-93	Deleting a Host Download Test Order	5-92
Figure 5-94	Automatic Result Upload	5-93
Figure 5-95	Host Upload Shown in the Test Information Area of the View Result Window	5-94
Figure 5-96	Select Test(s) to be Uploaded to the Host Window	5-95
Figure 5-97	Cepheid Link Scanner Login Screen	5-98
Figure 5-98	Cepheid Link Scan Sample Screen	5-99
Figure 5-99	Cepheid Link Scanner Success (Green Check Mark) Screen	5-100
Figure 5-100	Cepheid Link Scanner Error (Order Not Found (Red X)) Screen	5-100
Figure 5-101	Sample ID Manual Barcode Entry	5-101
Figure 5-102	Cepheid Link Scan Cartridge Screen	5-101
Figure 5-103	Cepheid Link Scanned Cartridge Information Screen	5-103
Figure 5-104	Cepheid Link Scanned Cartridge Error Screen	5-103
Figure 5-105	Cepheid Link Scan Aliquot Screen	5-104
Figure 5-106	Cepheid Link Confirmation Screen	5-104
Figure 5-107	Cepheid Link Scanner Drop Down Menu	5-105
Figure 5-108	Cepheid Link Scanner Logout Dialog	5-106
Figure 5-109	GeneXpert Dx Home Screen	5-107
Figure 5-110	Orders Table with Scan Cartridge Barcode Overlay Screen	5-108
Figure 5-111	Create Test Screen, showing Cartridge Query Completed	5-109
Figure 5-112	GeneXpert Home Screen, showing the Cartridge Loading Message	5-110
Figure 5-113	GeneXpert Dx System—About Drop-Down Menu	5-111
Figure 5-114	About GeneXpert Dx System Window	5-112
Figure 6-1	GeneXpert Dx System Screen Displaying Reports Menu	6-3
Figure 6-2	Control Trend Report Dialog Box Showing Qualitative Assay Selected	6-4
Figure 6-3	Select Analytes Dialog Box	6-5
Figure 6-4	Control Trend Report Dialog Box Showing Quantitative Assay Selected	6-6
Figure 6-5	Customize Graph Limits Dialog Box	6-6
Figure 6-6	Generate Report File Dialog Box	6-7
Figure 6-7	Example Control Trend Report in the Adobe Reader Window	6-8
Figure 6-8	Control Trend Report Qualitative Assay Example (C. difficile G2), Page 1	6-9
Figure 6-9	Control Trend Report Qualitative Assay Example (C. difficile G2) Page 2	6-10
Figure 6-10	Control Trend Report Quantitative Assay Example (HIV-1 Viral Load), Page 1	6-11
Figure 6-11	Control Trend Report Quantitative Assay Example (HIV-1 Viral Load), Page 2	6-12
Figure 9-1	Maintenance Log	9-3
Figure 9-2	GeneXpert Dx System Window	9-8

List of Figures

Figure 9-3	The Plunger Rod Maintenance Dialog Box	9-9
Figure 9-4	Plunger Rod Cleaning Dialog Box	9-9
Figure 9-5	Plunger Rod Lowered into Cartridge Bay.	9-10
Figure 9-6	Lens Cleaning Brush (300-8330)	9-12
Figure 9-7	Inserting the Cleaning Brush into the I-CORE Slit	9-13
Figure 9-8	Old-Style Filters (Not User-Serviceable)	9-14
Figure 9-9	GeneXpert GX-II and GeneXpert GX-IV Instruments Positioned for Access to Fans	9-15
Figure 9-10	Removing Fan Filter Guard	9-16
Figure 9-11	Filter Removal	9-16
Figure 9-12	Installing the Fan Filter Guard	9-17
Figure 9-13	GeneXpert GX-XVI R1 Instrument Positioned for Access to Fans	9-19
Figure 9-14	Removing Fan Filter Guard	9-19
Figure 9-15	Replacement Filter and Guard Installed.	9-20
Figure 9-16	GeneXpert GX-XVI R2 Fan Filters	9-21
Figure 9-17	Removing the Fan Filter Guard and Filter	9-22
Figure 9-18	Replacing the Filter and Guard	9-23
Figure 9-19	GX-IV Instrument Positioned for Access to Filter.	9-24
Figure 9-20	Removing the Prefilter Retainer	9-25
Figure 9-21	Removing the Prefilter	9-25
Figure 9-22	Removing the HE Filter Retainer	9-26
Figure 9-23	Removing the HE Filter	9-26
Figure 9-24	Replacing the HE Filter	9-27
Figure 9-25	Replacing the HE Filter Retainer	9-27
Figure 9-26	Replacing the Prefilter and the Prefilter Retainer.	9-28
Figure 9-27	Module Reporters Window	9-29
Figure 9-28	Module Self-Test Dialog Box	9-30
Figure 9-29	Self-Test Dialog Box	9-30
Figure 9-30	GeneXpert Dx System Window	9-31
Figure 9-31	Exclude Modules From Test Dialog Box	9-32
Figure 9-32	System Log Report Window.	9-33
Figure 9-33	An Example of a System Log Report.	9-35
Figure 9-34	GeneXpert Dx System—Check Status Window.	9-39
Figure 9-35	GeneXpert Dx System—View Results Window—Errors Tab (Detail Users and Administrator View)	9-40
Figure 9-36	Check Status Button Normal (Check Mark Symbol)	9-56
Figure 9-37	Check Status Button Symbol Changed to X and Messages Displayed.	9-56

Figure 9-38	Upload Result To Host Dialog Box	9-57
Figure C-1	Control Panel Window	C-3
Figure C-2	Clock, Language, and Region Window	C-3
Figure C-3	Region and Language Window—Formats Tab	C-4
Figure C-4	Region and Language Screen—Language Selected	C-4
Figure C-5	Region and Language Screen—New Language Displayed	C-5
Figure C-6	Windows 10 Settings Window	C-6
Figure C-7	Region and Language Drop-Down Window	C-7
Figure C-8	Region and Language and Text Services and Input Languages Screens	C-7
Figure C-9	Add Input Language Screen with French Selected (Example)	C-8
Figure C-10	The Add Input Languages Window with all Entries	C-8
Figure C-11	Text Services and Region and Language Screen—General Tab	C-9
Figure C-12	Region and Language Screen—Keyboards and Languages Tab	C-10
Figure C-13	Control Panel Window	C-11
Figure C-14	Clock, Language, and Region Window	C-11
Figure C-15	Region and Language Drop-Down Window—Formats Tab	C-12
Figure C-16	Region and Language Screen—Administrative Tab	C-12
Figure C-17	Welcome Screen and New User Account Settings Screen	C-13
Figure C-18	Windows 7 Login Screen Showing Two-Letter Country Designation	C-14
Figure C-19	Drop-Down Language Menu—Welcome Screen (Windows 7)	C-15
Figure C-20	Windows 10 Login Screen Showing Three-Letter Country Designation	C-16
Figure C-21	Drop-Down Language Menu—Welcome Screen (Windows 10)	C-16
Figure C-22	Barcode 1: *HID Keyboard Emulation	C-17
Figure C-23	Barcode 2: *North American Standard USB Keyboard	C-17
Figure C-24	Barcode 3: Enable Keypad Emulation	C-17
Figure C-25	Barcode 4: Enable Keypad Emulation with Leading Zero	C-18
Figure C-26	Barcode 5: Enable	C-18
Figure C-27	International Configuration Barcode	C-18
Figure C-28	North American Configuration Barcode	C-19
Figure C-29	French Sample Barcode	C-19
Figure C-30	Italian Sample Barcode	C-20
Figure C-31	German Sample Barcode	C-20
Figure C-32	Portuguese Sample Barcode	C-20
Figure C-33	Spanish Sample Barcode	C-21
Figure C-34	Chinese Sample Barcode	C-21

List of Figures

Figure C-35	Russian Sample Barcode	C-21
Figure C-36	Japanese Sample Barcode	C-22
Figure D-1	Opening a .csv File to Configure AOO (Example)	D-1
Figure D-2	AOO Registration Screen.	D-2
Figure D-3	Text Import Screen, showing Default Settings	D-3
Figure D-4	Text Import Screen with New Settings Selected	D-4
Figure D-5	All Cells Selected	D-5
Figure D-6	Drop-Down Menu to select Column Width	D-5
Figure D-7	Column Width Dialog Box	D-6
Figure D-8	Final View of File with Columns Adjusted	D-6
Figure D-9	Format Saving Dialog Box	D-7

List of Tables

Table 1-1	Workflow for Installing and Setting Up the System	1-10
Table 1-2	Typical Test Workflow	1-11
Table 2-1	Example User Permission Policy for In Vitro Diagnostic Use	2-56
Table 2-2	User Task Descriptions	2-56
Table 3-1	GeneXpert Module Excitation and Emission Ranges (6-Color).	3-8
Table 3-2	GeneXpert Module Excitation and Emission Ranges (10-Color).	3-9
Table 4-1	Dimensions and Weight.	4-2
Table 4-2	Rated Current and Fuse Rating.	4-2
Table 4-3	Dimensions and Weight.	4-3
Table 4-4	Rated Current and Fuse Rating.	4-3
Table 5-1	Typical Workflow for Processing a Specimen	5-2
Table 8-1	Electrical Safety Labels on the Instruments.	8-3
Table 8-2	Other Safety Labels on the Instruments	8-3
Table 9-1	Maintenance Tasks and Frequency.	9-2
Table 9-2	Hardware Problems	9-37
Table 9-3	Errors that Occurred During a Test that is Not Aborted.	9-41
Table 9-4	Errors that Might Appear When a Test is Aborted.	9-43
Table 9-5	Errors that Might Appear During the Cartridge Loading Process	9-47
Table 9-6	Error Messages that Might Appear During the Self-Test Process.	9-48
Table 9-7	Data Reduction Errors	9-51
Table 9-8	Communication Loss/Recovery Errors	9-55
Table 9-9	System Configuration Problems	9-57
Table A-1	User	A-1
Table A-2	Data Management	A-1
Table A-3	Reports	A-2
Table A-4	Setup	A-2
Table A-5	About	A-2
Table A-6	Create Test	A-2
Table A-7	Stop Test	A-3
Table A-8	View Results	A-3
Table A-9	Define Assays	A-3
Table A-10	Maintenance	A-3

List of Tables

1 Introduction—Use or Function

This chapter provides an overview of the GeneXpert Dx system. The topics are:

- Section 1.1, Intended Use
- Section 1.2, Terms Used for System Descriptions
- Section 1.3, Models of GeneXpert Instruments
- Section 1.4, 6-Color and 10-Color Modules
- Section 1.5, System Components
- Section 1.6, GeneXpert Cartridges
- Section 1.7, GeneXpert Dx Software
- Section 1.8, Workflow Overview
- Section 1.9, Before Operating the Instrument

Note

GeneXpert Dx software version 6.2 supports the Microsoft Windows 7 and Windows 10 operating systems. Should you need any assistance, please contact your regional Cepheid Technical Support center.

Important

Support for Windows XP ended April 8, 2014. Microsoft no longer provides security updates or technical support for the Windows XP operating system. It is critical that you upgrade now to a newer operating system, such as Windows 10.

Please contact <https://www.microsoft.com/en-us/microsoft-365/windows/end-of-windows-xp-support> for Windows XP support information.

In addition, please contact your local Cepheid Technical Support if you have questions about using Windows XP.

Important

Support for Windows 7 ended January 14, 2020. Microsoft no longer provides security updates or technical support for the Windows 7 operating system. It is critical that you upgrade now to a newer operating system, such as Windows 10.

Please contact <https://www.microsoft.com/en-us/microsoft-365/windows/end-of-windows-7-support> for Windows 7 support information.

In addition, please contact your local Cepheid Technical Support if you have questions about using Windows 7.

1.1 Intended Use

The GeneXpert Dx system automates and integrates sample preparation, nucleic acid amplification, and detection of the target sequence in simple or complex samples using real-time Polymerase Chain Reaction (PCR). The system is suited for *in vitro* diagnostic applications that require hands-off processing of patient samples (specimens) and provides both summarized and detailed test results data in tabular and graphic formats.

The GeneXpert Dx System is designed exclusively for the use of Cepheid Xpert assay applications. It allows a laboratory healthcare professional to run tests on the GeneXpert Dx platform using predefined assays.

1.2 Terms Used for System Descriptions

In this manual, the following terms are used to describe the GeneXpert Dx systems:

- GeneXpert Dx system refers to the complete system including the computer, GeneXpert instrument and barcode scanner.
- GeneXpert instrument refers only to the components used to process the samples. See [Figure 1-2](#), [Figure 1-3](#), [Figure 1-4](#), [Figure 1-5](#), [Figure 1-6](#), [Figure 1-7](#), [Figure 1-8](#) and [Figure 1-9](#) for examples of GeneXpert instruments.

1.3 Models of GeneXpert Instruments

There are three different GeneXpert R1 instruments:

- The GeneXpert GX-I instrument consists of one module (or one site) to process one sample. Up to four GeneXpert GX-I instruments can be connected to one computer.
- The GeneXpert GX-IV instrument consists of up to four modules. Each module processes one sample. Up to four GeneXpert GX-IV instruments can be connected to one computer.
- The GeneXpert GX-XVI instrument consists of up to sixteen modules. Each module processes one sample.

There are four different models of GeneXpert R2 instruments:

- The GeneXpert GX-I instrument consists of one module (or one site) to process one sample. Up to four GeneXpert GX-I instruments can be connected to one computer.
- The GeneXpert GX-II instrument consists of one or two modules. Each module processes one sample. Up to four GeneXpert GX-II instruments can be connected to one computer.
- The GeneXpert GX-IV instrument consists of up to four modules. Each module processes one sample. Up to four GeneXpert GX-IV instruments can be connected to one computer.

- The GeneXpert GX-XVI instrument consists of up to sixteen modules. Each module processes one sample. One GeneXpert GX-XVI instrument can be connected to one computer.

For purposes of this document, the GeneXpert Dx systems function identically and will not be identified as R1 or R2 unless there is a specific difference noted.

1.4 6-Color and 10-Color Modules

An instrument can have either 6-color or 10-color modules. A 10-color module can be identified by a blue stripe on the upper edge of the module door, as shown in [Figure 1-1](#). See [Section 3.7](#) for further information on module types.



Figure 1-1. GX-IV Instruments, showing 6- and 10-Color Modules

1.5 System Components

The components of the GeneXpert Dx systems are as follows:

- **GeneXpert Instrument**—Accepts the GeneXpert cartridges that are loaded into the instrument, lyses the samples in the cartridges, releases the nucleic acids, and amplifies the target sequences. Because the system allows control of the modules independently, different samples can be processed using different assay definitions in the same instrument at the same time.
- **Desktop or Laptop Computer**—Allows you to run the GeneXpert Dx system software and hosts the GeneXpert Dx system results database. The software allows the selection of assay definitions, monitoring of test process, viewing results, and exporting of selected data to downstream software, such as Microsoft Excel, for additional analysis. The software also allows the archiving and retrieval of the results data and management of the database. Cepheid Link connectivity is provided to enable cartridge traceability.

Note Desktop and laptop computer manufacturers and models may vary from those shown in this manual.

- **Barcode Scanner**—Facilitates data entry in the system.

1.5.1 GeneXpert Dx System Components

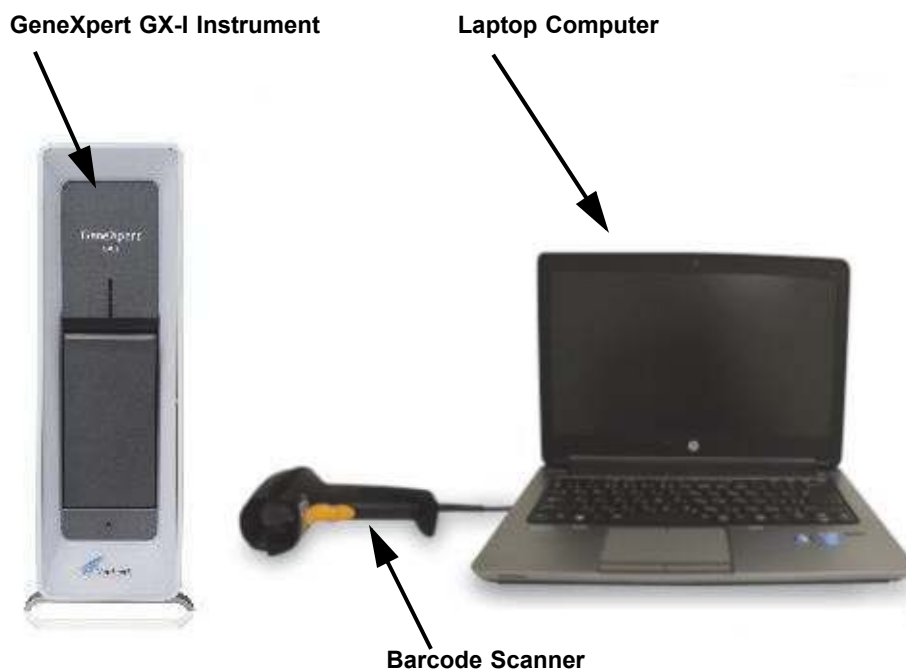

Figure 1-2. GeneXpert GX-I Hardware Components (Shown with the Laptop Computer)

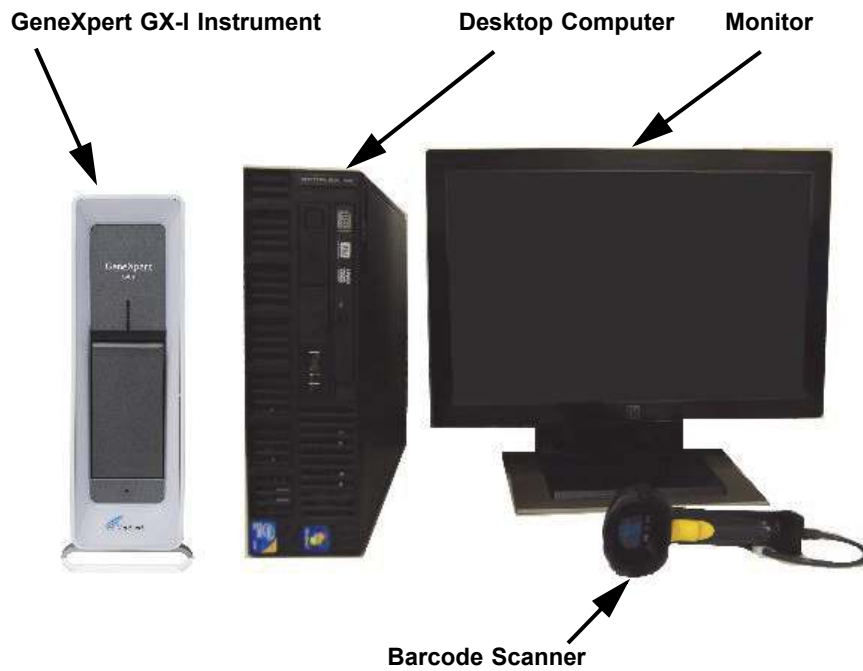

Figure 1-3. GeneXpert GX-I Hardware Components (Shown with the Desktop Computer)

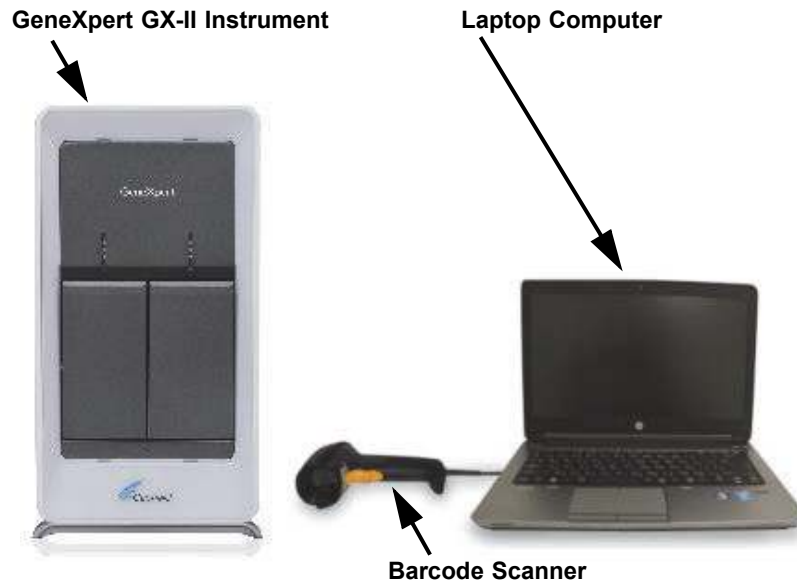

Figure 1-4. GeneXpert GX-II Hardware Components (Shown with the Laptop Computer)

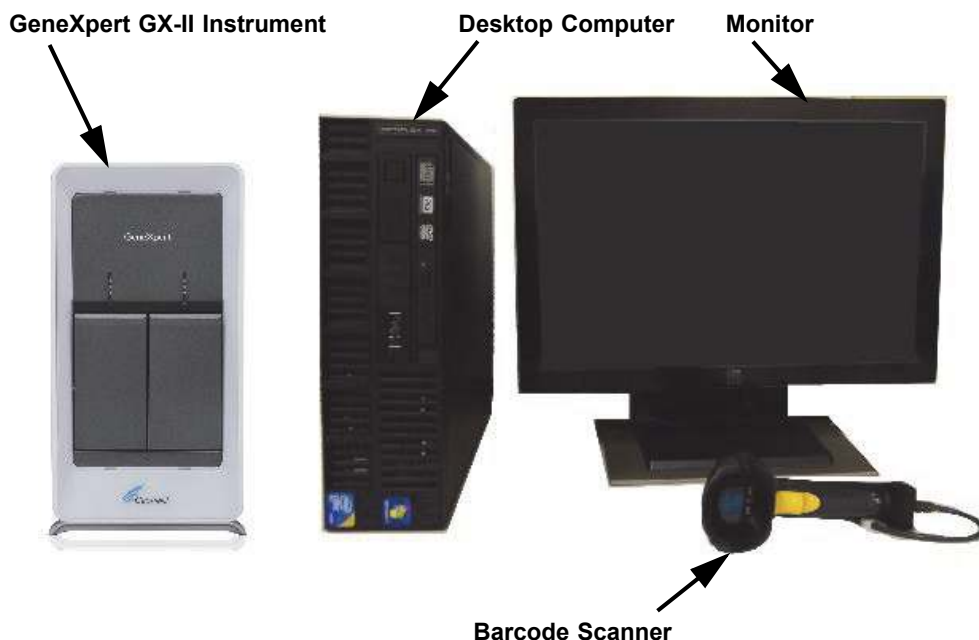

Figure 1-5. GeneXpert GX-II Hardware Components (Shown with the Desktop Computer)

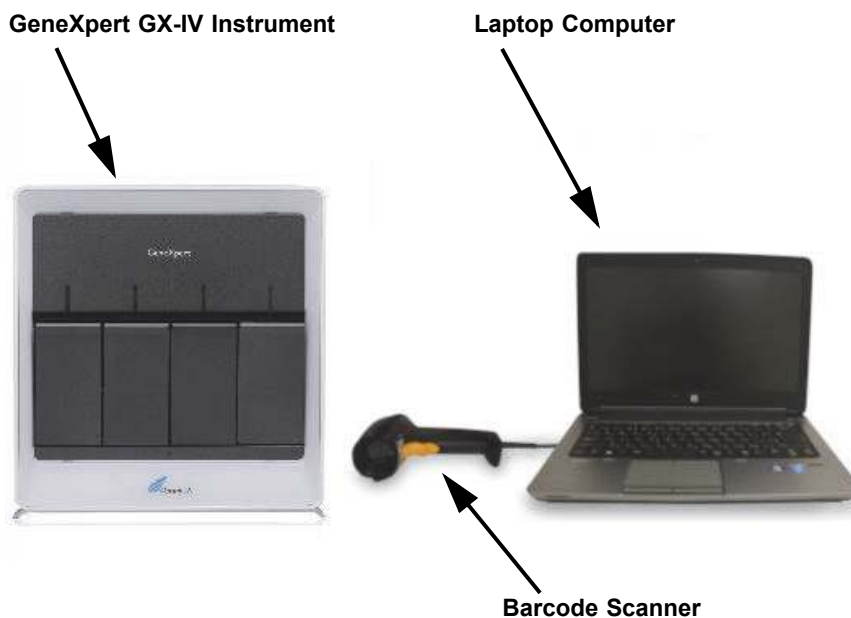

Figure 1-6. GeneXpert GX-IV Hardware Components (Shown with the Laptop Computer)

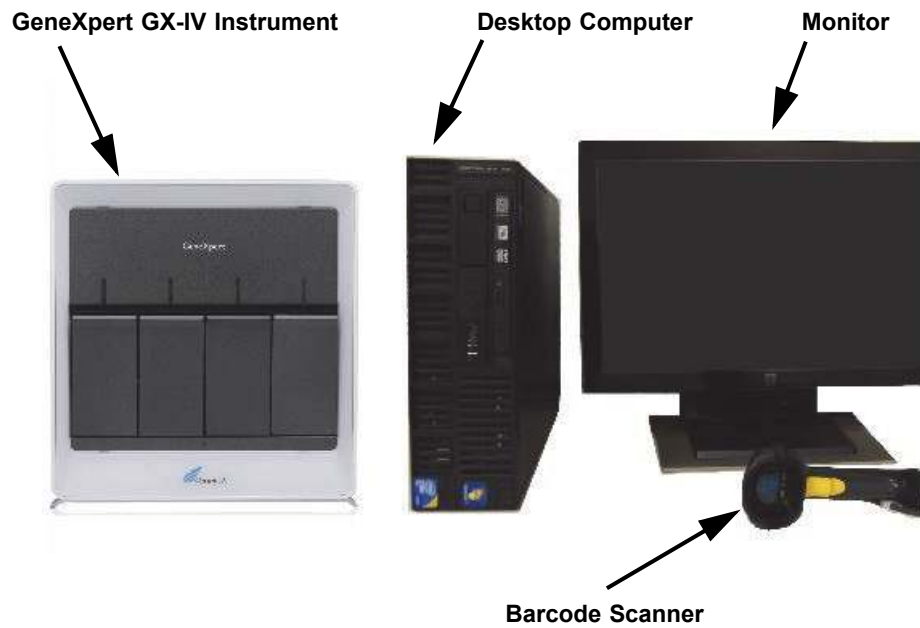

Figure 1-7. GeneXpert GX-IV Hardware Components (Shown with the Desktop Computer)

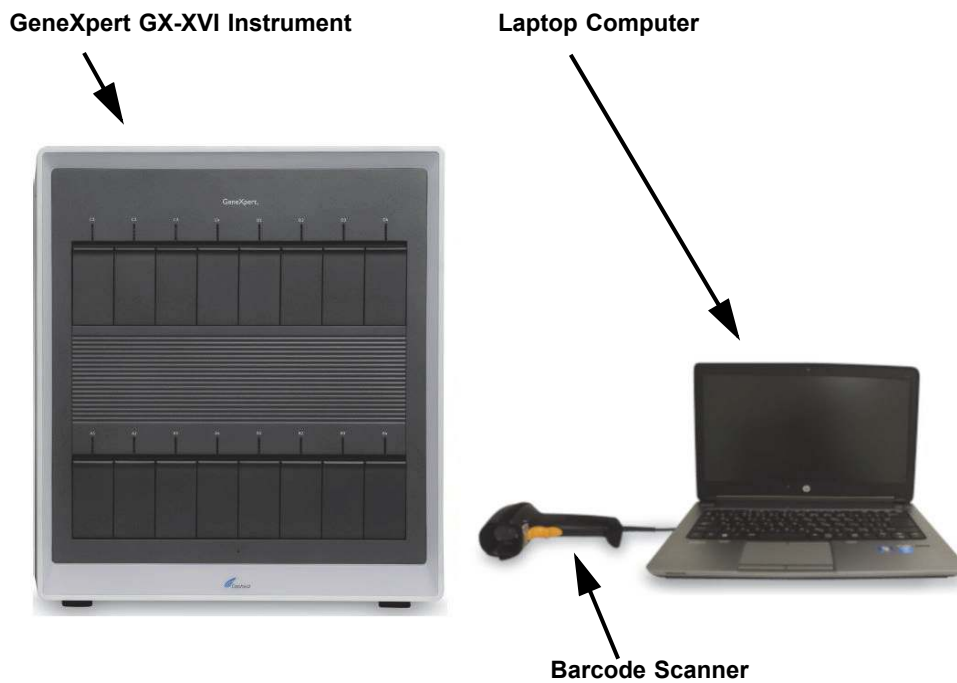

Figure 1-8. GeneXpert GX-XVI Hardware Components (Shown with the Laptop Computer)

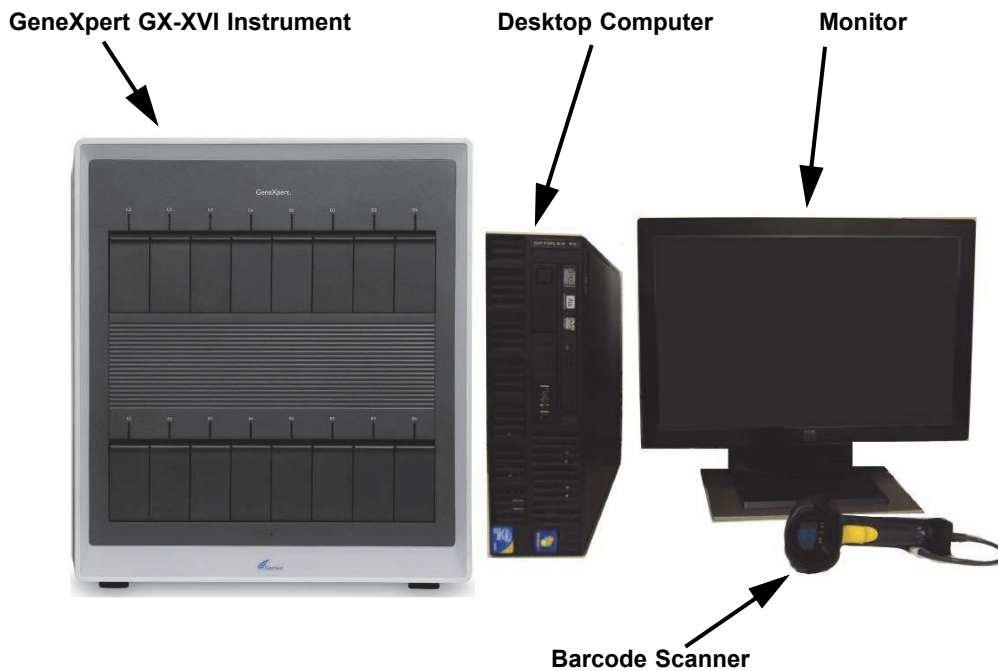

Figure 1-9. GeneXpert GX-XVI Hardware Components (Shown with the Desktop Computer)

1.6 GeneXpert Cartridges

- The samples are prepared and processed in single-use, assay-specific GeneXpert cartridges (see [Figure 1-10](#)). The sample and applicable reagents are inserted into a cartridge and then the cartridge is loaded into one of the available instrument modules.
- The cartridges are not supplied with the system and must be purchased separately. For ordering information, contact Cepheid. See the [Technical Assistance](#) section in the [Preface](#) for the contact information.



Figure 1-10. GeneXpert Cartridge

1.7 GeneXpert Dx Software

The GeneXpert Dx software is installed on the supplied computer and can accommodate a variety of applications. This section describes the software features that are for *in vitro* diagnostic use (Figure 1-11):

- **Administrative tasks**—Configure the system to accommodate the organization's preferences, define system users and set up permissions (access privileges), import and delete *in vitro* diagnostic assay definitions, generate external control trend reports, and manage the test data in the database.
- **Test tasks**—Create and start an *in vitro* diagnostic test, stop a test in progress, monitor a test in progress, view the test results, edit test information, and generate test reports.
- **Maintenance tasks**—Perform various maintenance tasks which include using the Module Reporters tool and Plunger controls for cleaning the module plungers, performing a self-test manually for troubleshooting and checking the calibration and test counts, and utilizing commands for opening a module door or updating the EEPROM.

For a summary of the workflows for *in vitro* diagnostic use, see [Section 1.8, Workflow Overview](#).

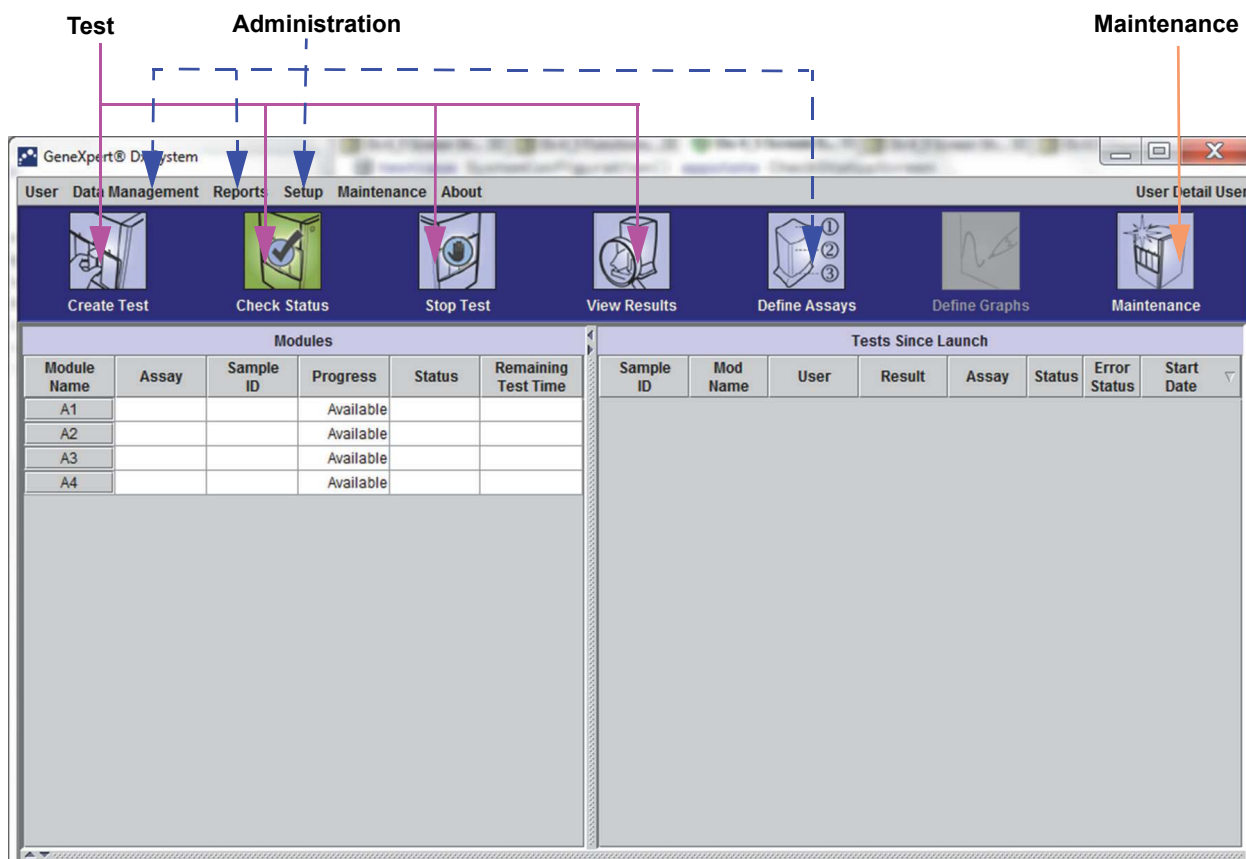

Figure 1-11. The GeneXpert Dx Software Features

1.8 Workflow Overview

The GeneXpert Dx system workflow covers the following tasks:

- [Section 1.8.1, Installation and Setup Workflow](#)
- [Section 1.8.2, Test Workflow](#)

1.8.1 Installation and Setup Workflow

[Table 1-1](#) lists the tasks for installing and setting up the GeneXpert Dx system. Note that although *in vitro* diagnostic assay definition files can be imported, the GeneXpert Dx system software does not allow the modification of the assay definitions.

Table 1-1. Workflow for Installing and Setting Up the System

Step	Task	Section
1.	Install the GeneXpert Dx system.	Section 2.5
2.	Turning on the computer.	Section 2.6
3.	Start the software.	Section 2.11
4.	Assign instrument letters. (Optional)	Section 2.12
5.	Define users and permissions.	Section 2.13
6.	Configure the system.	Section 2.14
7.	Verify proper installation and setup.	Section 2.15
8.	Manage assay definition files.	Section 2.16

After the system is installed and running, the following tasks can be performed:

- Add new users (see [Section 2.13.3.1, Adding New Users](#)).
- Install additional GeneXpert instruments (see [Section 2.5.2, To Install Additional Instruments](#)).

1.8.2 Test Workflow

Table 1-2 lists the tasks for processing a specimen sample using the GeneXpert Dx system. Note that although *in vitro* diagnostic assay definition files can be imported, the GeneXpert Dx software does not allow modification of the assay definitions (see Section 1.7, *GeneXpert Dx Software*). For systems connected to a host, see Section 5.20, *Operating with Host Connectivity* for the test workflow.

Table 1-2. Typical Test Workflow

Step	Task	Section
1.	Start the GeneXpert Dx system.	Section 5.2
2.	Check the list of assays available. Import the assay definition files if necessary.	Section 5.4 and Section 2.16
3.	Create a test.	Section 5.6
4.	Load a cartridge into an instrument module.	Section 5.7
5.	Start the test.	Section 5.8
6.	Monitor the test progress.	Section 5.9
7.	View the test results.	Section 5.11
8.	Manage the test results data.	Section 5.16
9.	Maintain the system.	Chapter 9

Figure 1-12 is a graphical overview of the test workflow.

1. Check the list of assays (Section 5.4)
2. Create and start a test (Section 5.6 and Section 5.8)
3. Monitor the test progress (Section 5.9)
4. View the results (Section 5.11)

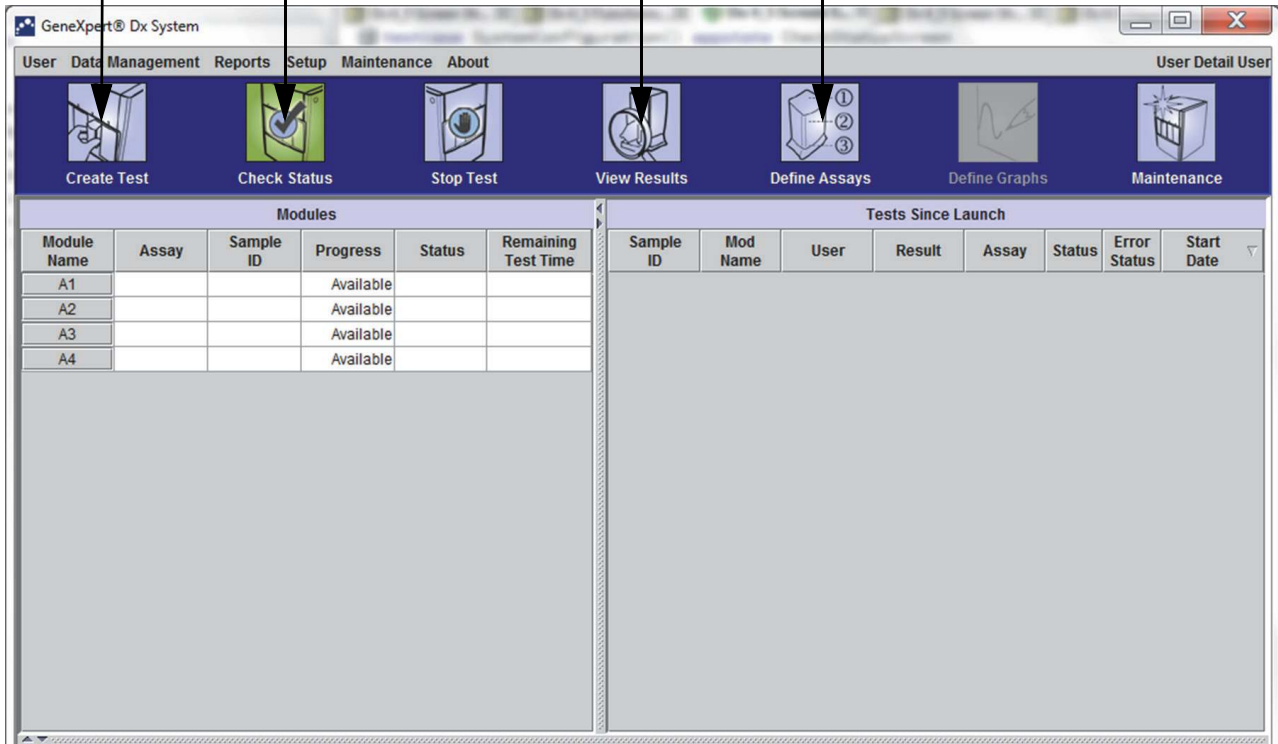

Figure 1-12. GeneXpert Dx System Window and the Typical Test Workflow

1.9 Before Operating the Instrument

Read the entire manual and become familiar with the safety information in [Chapter 8, Hazards](#) before starting to operate the instrument.

Warning



Using the instrument without reading the manual or without proper training can result in serious injury, damage to the equipment or loss of data.

2 Installation Procedures and Special Requirements

This chapter describes how to install and set up the system. Except when noted, the procedures in this chapter are for the GeneXpert Dx system administrator or equivalent personnel. The topics are as follows:

- [Section 2.1, GeneXpert Dx System Package Contents](#)
- [Section 2.2, Required Materials for Use with the System \(But Not Provided\)](#)
- [Section 2.3, Recommended Materials for Use with the System](#)
- [Section 2.4, System Notes](#)
- [Section 2.5, Installing the GeneXpert Dx System](#)
- [Section 2.6, Turning On the Computer](#)
- [Section 2.7, Disk Encryption \(Windows 10\)](#)
- [Section 2.8, Windows Language and Keyboard Configuration](#)
- [Section 2.9, Configuring the Computer](#)
- [Section 2.10, Controlling Windows 10 Automatic Updates](#)
- [Section 2.11, Starting the Software for the First Time](#)
- [Section 2.12, Assigning Instrument Letters](#)
- [Section 2.13, Defining Users and Permissions](#)
- [Section 2.14, Configuring the System](#)
- [Section 2.15, Verifying Proper Installation and Setup](#)
- [Section 2.16, Managing Assay Definitions and Lot Specific Parameters](#)
- [Section 2.17, Restarting the System](#)
- [Section 2.18, Uninstalling or Reinstalling GeneXpert Dx Software](#)

2.1 GeneXpert Dx System Package Contents

- The GeneXpert Dx system package contains the following items:
- GeneXpert instrument
- Desktop or laptop computer, preloaded with the GeneXpert Dx software and other required software
- Network switch (included if the system has two or more instruments)
- 2D barcode scanner
- Power cord, type: IEC-320-13, 10A/125V North America or 10A/250V International for:
 - GeneXpert GX-I R1
 - GeneXpert GX-IV R1/R2, and
 - GeneXpert GX-XVI R1/R2
- DC Adapter Power cable (for GeneXpert GX-I R2 and GeneXpert GX-II R2)
- CAT-5 Ethernet[®] crossover cable
- External DVD drive
- *GeneXpert Dx System Operator Manual* CD
- Certificate of Compliance

2.2 Required Materials for Use with the System (But Not Provided)

The following items are required for use with the GeneXpert Dx system but are not included in the package:

- Assay-specific GeneXpert cartridges
- Assay-specific requirements (refer to the assay package insert or your local and national regulatory guidelines)

To order the GeneXpert cartridges, contact Cepheid. See the [Technical Assistance](#) section in the [Preface](#) for the contact information.

2.3 Recommended Materials for Use with the System

- Uninterruptible Power Supply (UPS)
- Printer

To order the printer or UPS, contact Cepheid. See the [Technical Assistance](#) section in the [Preface](#) for contact information.

2.4 System Notes

2.4.1 System Components

Cepheid tested and qualified the GeneXpert Dx system components to provide optimal performance.

Caution



Do not alter the computer settings, pre-installed software, and other system components unless instructed by Cepheid to do so. Do not install non-approved software. Do not replace system parts without assistance from Cepheid.

Altering the computer settings, pre-installed software, or other system components without guidance from Cepheid can result in the loss of data, impact system performance, damage the instrument, and void your warranty.

Important

Do not load any new version of Microsoft SQL applications.

2.4.2 Network Connection

The GeneXpert Dx system computer contains two Ethernet cards. The card that is configured for the GeneXpert instrument is labeled on the back of the computer. Use only the supplied Ethernet cable to connect the computer to the instrument. See [Section 2.5.1, To Install a GeneXpert Dx System](#), for detailed installation instructions.

Caution



Do not change the Internet Protocol (IP) setting for the Ethernet connection to the GeneXpert Dx system. Changing the IP setting can cause instrument communication failure.

2.4.3 Software Media

Microsoft Windows has been installed and activated on the GeneXpert Dx system computer. Microsoft recovery media and GeneXpert software media are included in the computer shipping box.

Important

Store the media in a safe place in the original packaging. If you must reinstall the software, the original media will be needed. In addition, to reactivate the software, the product key (located on the Certificate of Authenticity that is on the installation media packaging) will also be needed.

2.5 Installing the GeneXpert Dx System

Caution



A 6-color GeneXpert Dx system and modules require software version 2.1 (or above) and a 10-color GeneXpert Dx system and modules require software version 6.1 and above.

To avoid hardware failures, GeneXpert Dx 2.1 (or above) software must be installed **BEFORE** connecting and powering up a 6-color instrument or upgrade modules, and GeneXpert Dx 6.1 (and above) software must be installed **BEFORE** connecting and powering up a 10-color instrument or upgrade modules.

Warning



See the weights table in [Section 4.2, General Specifications](#) for GeneXpert instrument weights. Use care when unpacking the instrument. Do not attempt to lift the instrument without proper safety training and assistance. Lifting or moving the instrument without proper training and assistance can cause personal injury, damage the instrument, and void your warranty.

Important

Before installing the instrument, read [Chapter 4, Performance Characteristics and Specifications](#) and [Chapter 7, Operational Precautions and Limitations](#) to become familiar with the system specifications and requirements.

2.5.1 To Install a GeneXpert Dx System

The following sections describe the installation of GeneXpert Dx systems.

1. Unpack the system and make sure the package contains the items in [Section 2.1](#).
2. Place the instrument on a hard, sturdy, level surface. Make sure the power cord connection and the power switch (on the back side) are easily accessible.

Caution



Provide at least 5 cm (2 in) of clearance on each side of the instrument. Do not block the fan exhaust on the lower back side or the air intake on the upper back side. The lack of proper ventilation can cause the instrument to malfunction.

3. Connect one end of the supplied Ethernet cable to the network port on the back side of the computer (depending on the GeneXpert model, see [Figure 2-1](#), [Figure 2-2](#), [Figure 2-3](#) or [Figure 2-4](#) for desktop computer systems and [Figure 2-5](#), [Figure 2-6](#), [Figure 2-7](#) or [Figure 2-8](#) for laptop computer systems). A label indicates that the port is for use with the GeneXpert instrument.

Important

Use the supplied Ethernet cable to connect the GeneXpert instrument and the computer. If the cable is missing or an additional cable is needed, contact Cepheid Technical Support. See the [Technical Assistance](#) section in the [Preface](#) for the contact information. See [Section 9.17, Replacing Instrument Parts](#) for the part number.

Caution



Do not change the Internet Protocol (IP) setting for the Ethernet connection to the GeneXpert instrument. Changing the IP setting can cause an instrument communication failure.

Note

The computer supplied with the GeneXpert instrument should have been set to the correct IP address before it left the factory, but if the computer is not communicating with the instrument, perform the steps shown in [Section 2.9.3, IP Address](#).

4. Connect the other end of the Ethernet cable to the network port on the lower back panel of the instrument (see [Figure 2-1](#), [Figure 2-2](#), [Figure 2-3](#), or [Figure 2-4](#) for desktop computer systems and [Figure 2-5](#), [Figure 2-6](#), [Figure 2-7](#) or [Figure 2-8](#) for laptop computer systems).
5. Connect the supplied power cords (or DC adapter power cable) to the instrument and the computer, and then connect the power cords to AC power or to an uninterruptible power supply (UPS).

Caution



Make sure the UPS is connected to a properly grounded circuit. Using a non-grounded circuit can cause damage to the instrument.

6. Perform the steps provided in [Section 2.6, Turning On the Computer](#), or if multiple instruments are being set up, perform the steps provided in [Section 2.5.2, To Install Additional Instruments](#).

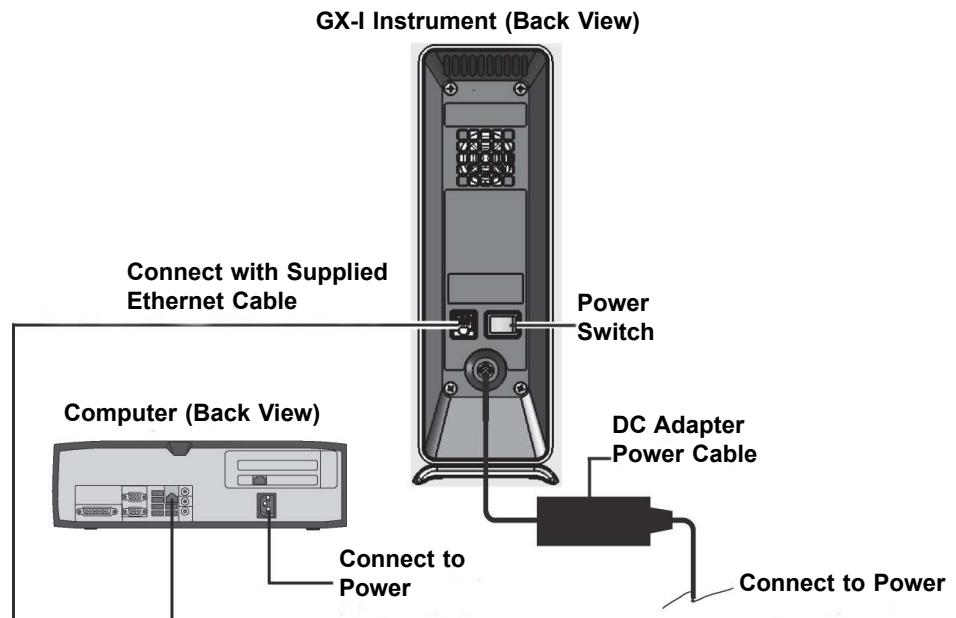

Figure 2-1. Connecting the GX-I Instrument to the Desktop Computer

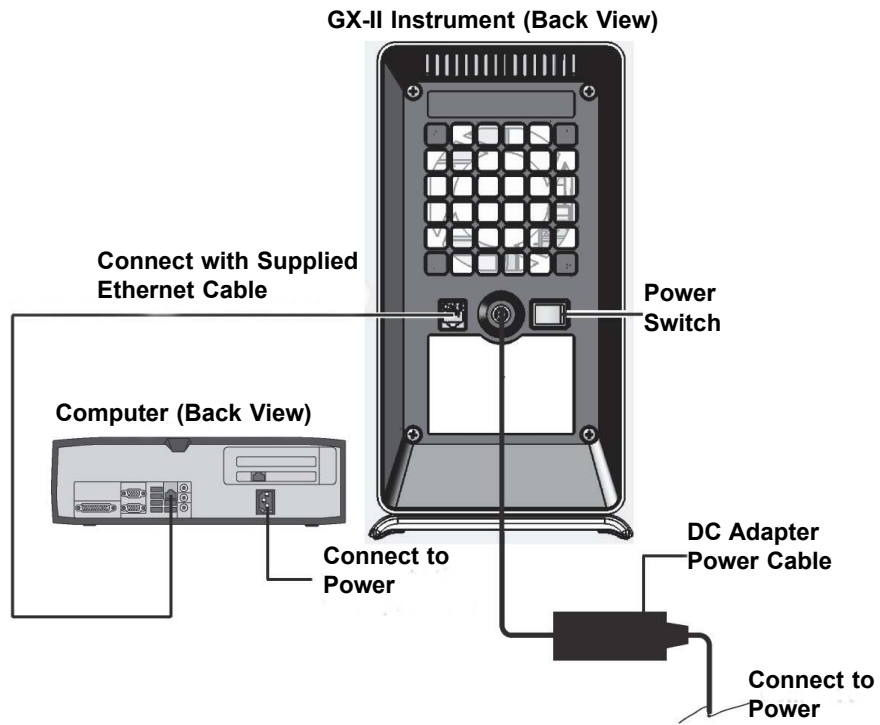

Figure 2-2. Connecting the GX-II Instrument to the Desktop Computer

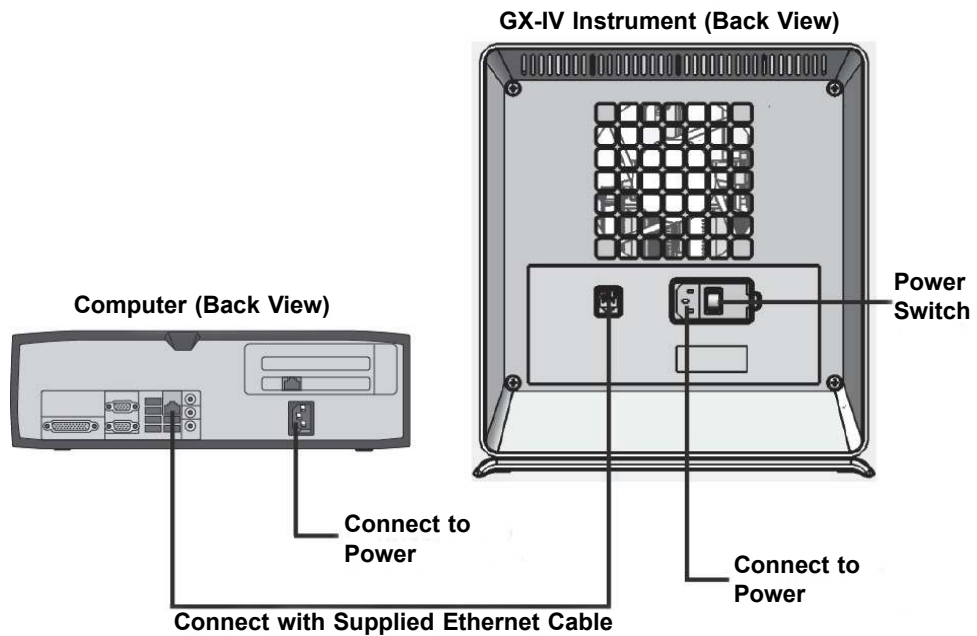

Figure 2-3. Connecting the GX-IV Instrument to the Desktop Computer

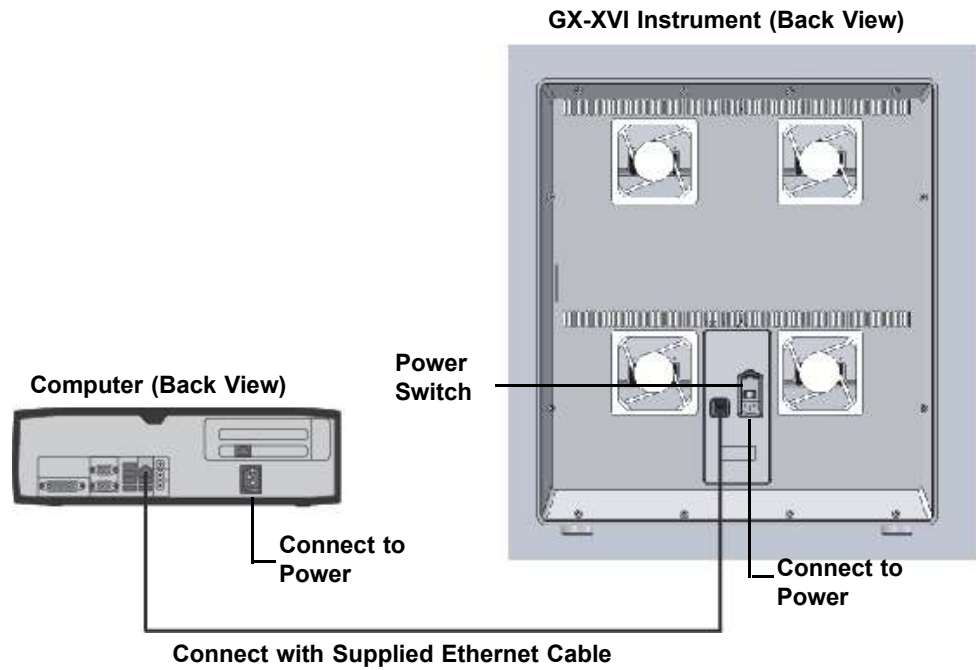

Figure 2-4. Connecting the GX-XVI Instrument to the Desktop Computer

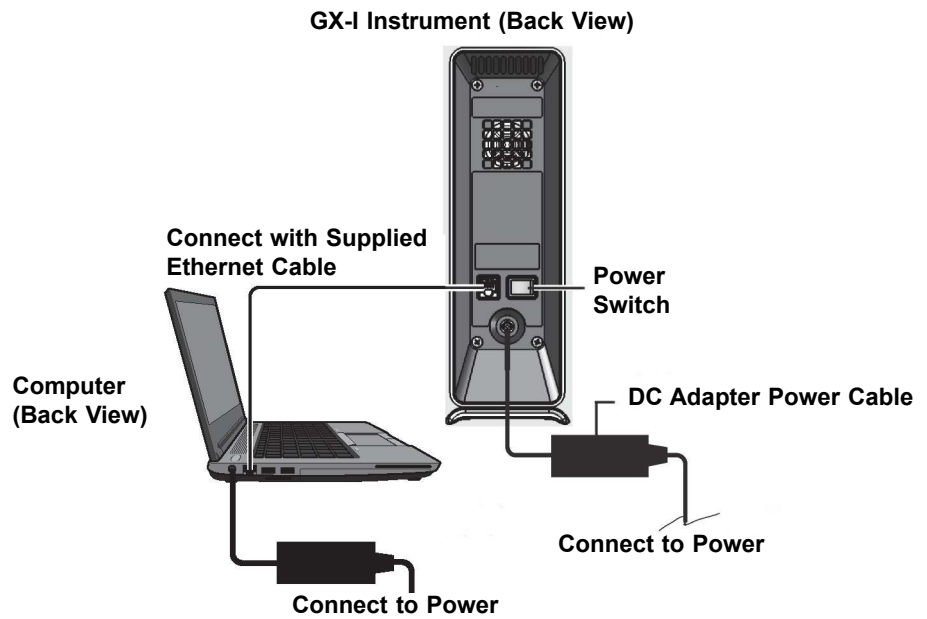

Figure 2-5. Connecting the GX-I Instrument to the Laptop Computer

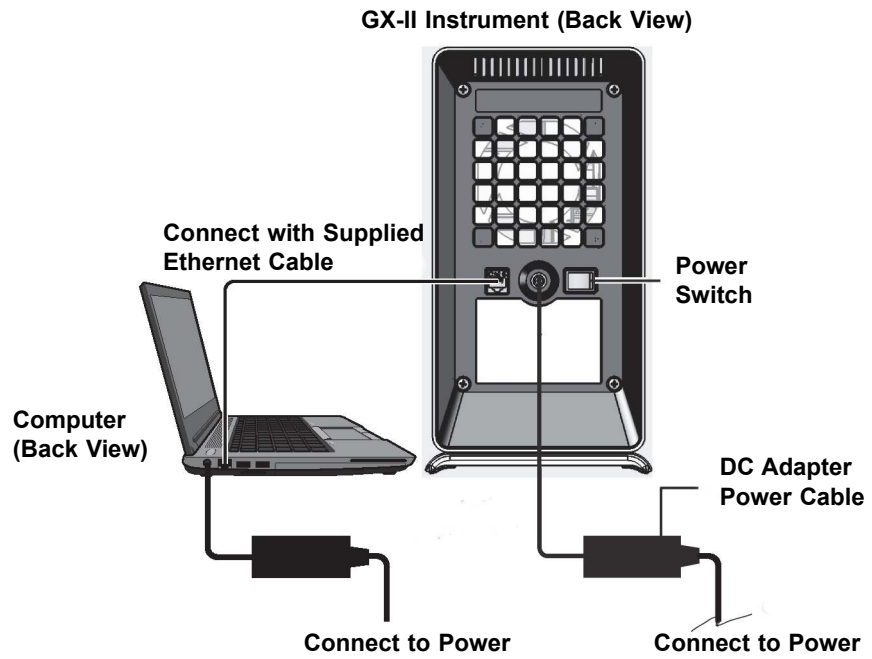

Figure 2-6. Connecting the GX-II Instrument to the Laptop Computer

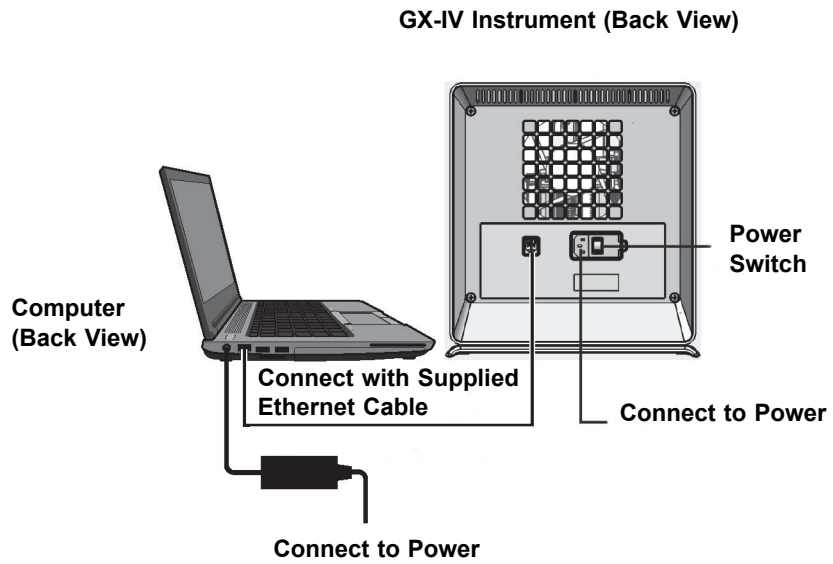

Figure 2-7. Connecting the GX-IV Instrument to the Laptop Computer

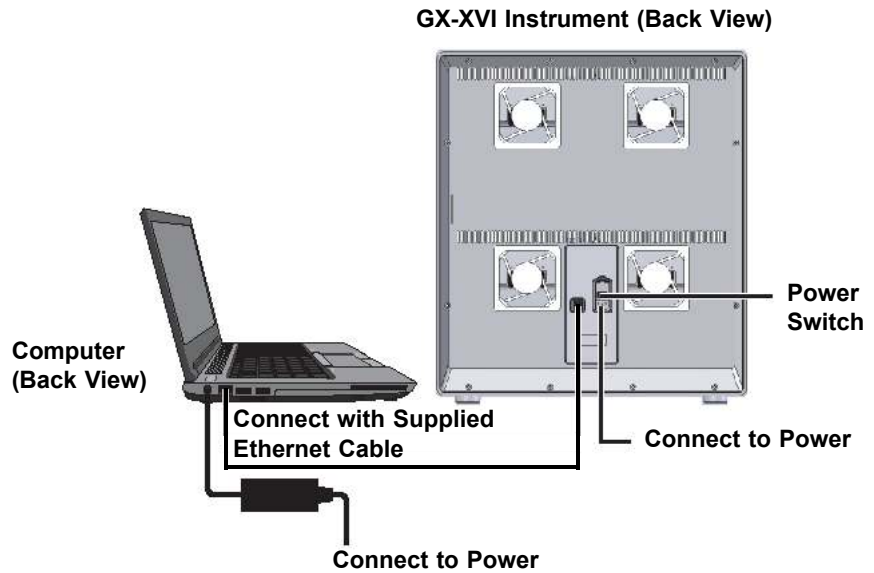

Figure 2-8. Connecting the GX-XVI Instrument to the Laptop Computer

2.5.2 To Install Additional Instruments

Caution



Before installing additional instruments, make sure the GeneXpert Dx software is not running.

Caution



A 6-color GeneXpert Dx system and modules require software version 2.1 (or above), and a 10-color GeneXpert Dx system and modules require software version 6.1 and above.

To avoid hardware failures, GeneXpert Dx 2.1 (or above) software must be installed **BEFORE** connecting and powering up a 6-color instrument or upgrade modules, and GeneXpert Dx 6.1 (and above) software must be installed **BEFORE** connecting and powering up a 10-color instrument or upgrade modules.

Note

The computer does not have to be turned off to connect additional instruments.

Up to 22 GeneXpert modules (10- or 6-color) in any combination of GeneXpert GX-I, GeneXpert GX-II, or GeneXpert GX-IV or GeneXpert XV1 instruments can be connected to a single computer. In the multiple-instrument setup, connect the computer to the supplied network switch, and then connect the instruments to the switch. See [Figure 2-9](#) for desktop computer systems and [Figure 2-10](#) for laptop computer systems.

1. Unpack the additional instrument(s), power cords, network switch, and Ethernet cables.
2. If the GeneXpert Dx software is currently running, quit the software.
3. Disconnect the Ethernet cable from the back of the previously installed instrument. Keep the Ethernet cable connected to the computer.

4. Connect the free end of the Ethernet cable in [Step 3](#) to any of the available ports in the network switch. The Ethernet cable is used to connect the computer to the network switch.
5. Using a second Ethernet cable, connect the additional instrument to any available port in the network switch. One end of the Ethernet cable connects to the network port on the back of the instrument, and the other end connects to a free port of the network switch.
6. Repeat [Step 5](#) to connect additional instruments to the network switch.
7. Connect the supplied power cord to the additional instrument, and then connect the power cord into the UPS. Repeat this step for each additional instrument.

Note

Leave the instruments **OFF** until the computer is set up.

8. Connect the barcode scanner directly to an available computer USB port. Do not connect the scanner to a USB hub.
9. Perform the steps given in [Section 2.6, Turning On the Computer](#).

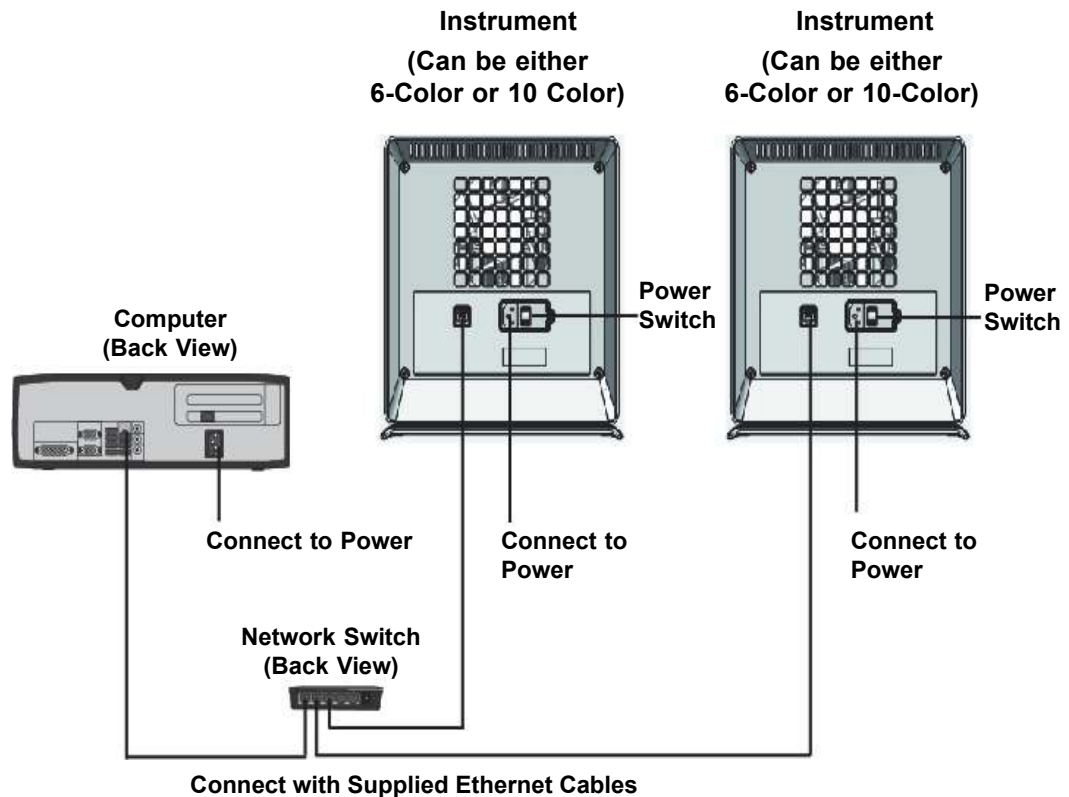

Figure 2-9. Connecting Multiple GX-IV Instruments to the Desktop Computer

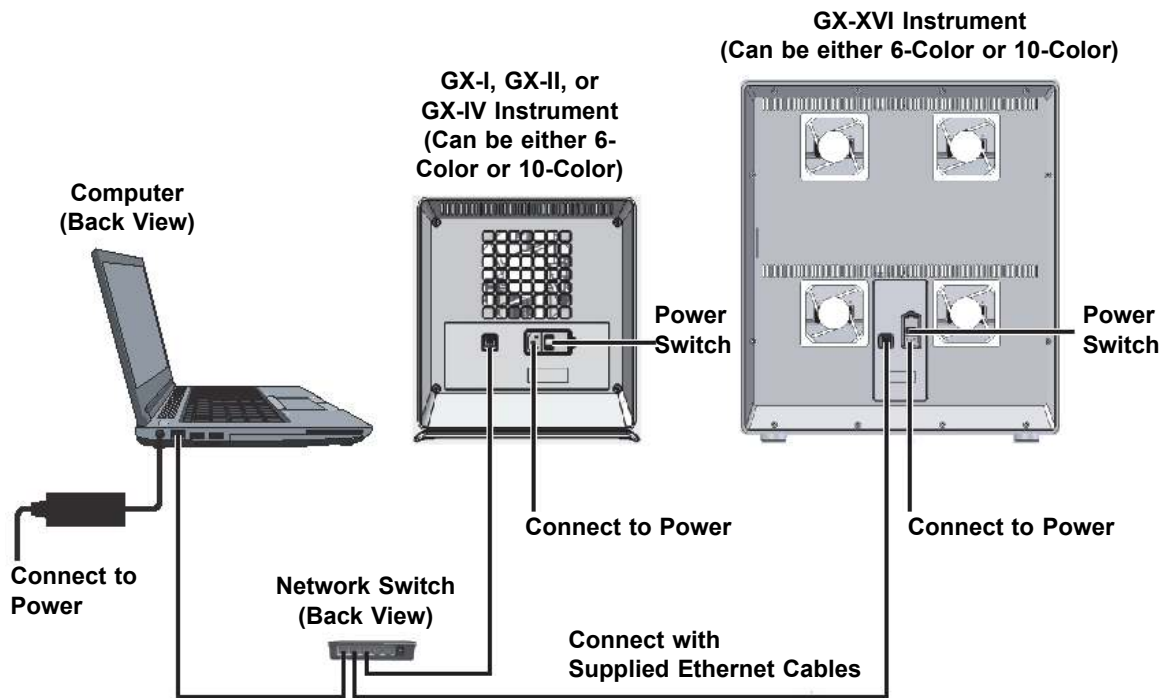

Figure 2-10. Connecting Multiple Instruments to the Laptop Computer

2.5.3 Connecting to Cepheid C360

C360 Analytics is an intelligent remote medical device data system that provides data aggregations and analysis for monitoring epidemiology in a healthcare setting. These solutions help maximize the utility and application of Cepheid products by integrating several information management tools.

Use the following procedure to connect to the Cepheid C360 network.

1. Unpack the additional Ethernet cable and USB to Ethernet adapter.
2. If the GeneXpert Dx software is currently running, quit the software.
3. Confirm that the primary Ethernet connection from the computer to the Instrument (see [Figure 2-11](#)) or Network Switch (for multiple instruments as shown in [Figure 2-12](#)) uses IP address **10.11.14.1**.
4. Connect the USB connector on the adapter to any available USB port on the computer.
5. Using the second Ethernet cable, connect the adapter to your network. By default, the IP address is assigned using DHCP.

Note

If you wish to use a static IP address, contact your IT department for support in assigning the address for the LIS interface.

- Log into the Cepheid C360 website to set up your system. Refer to the *C360 Analytics Quick Reference Guide* for details.

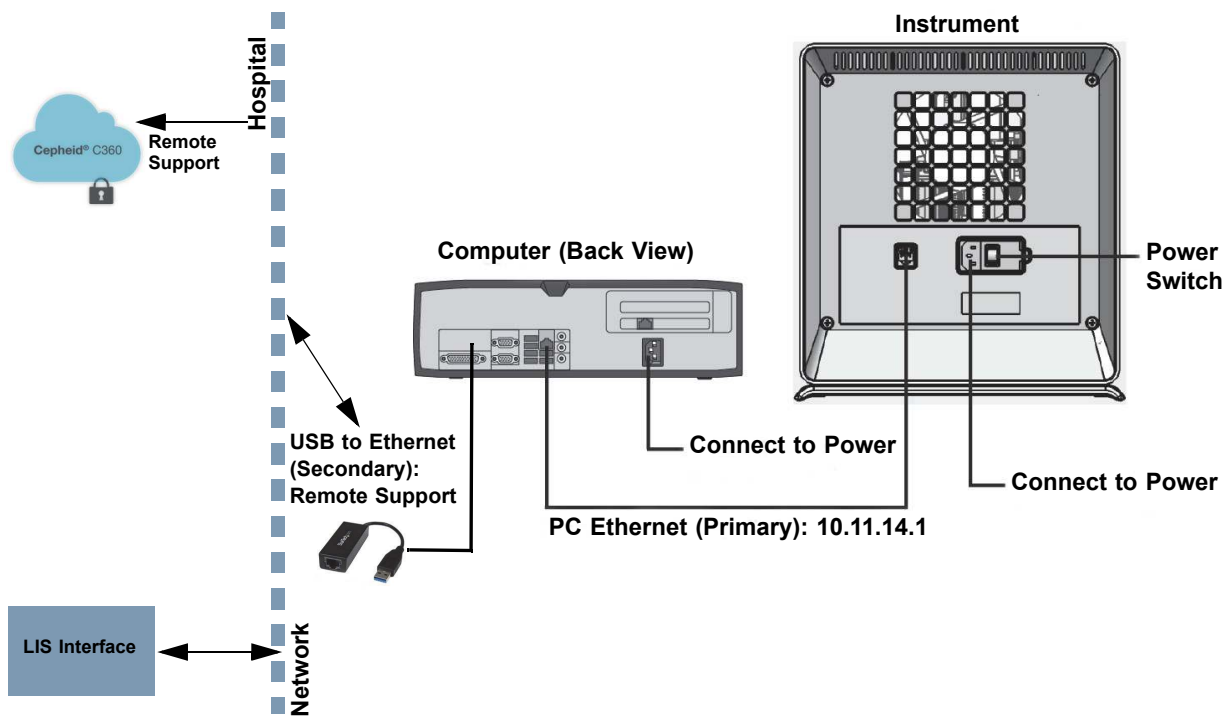

Figure 2-11. Connecting GX-IV Instrument to C360

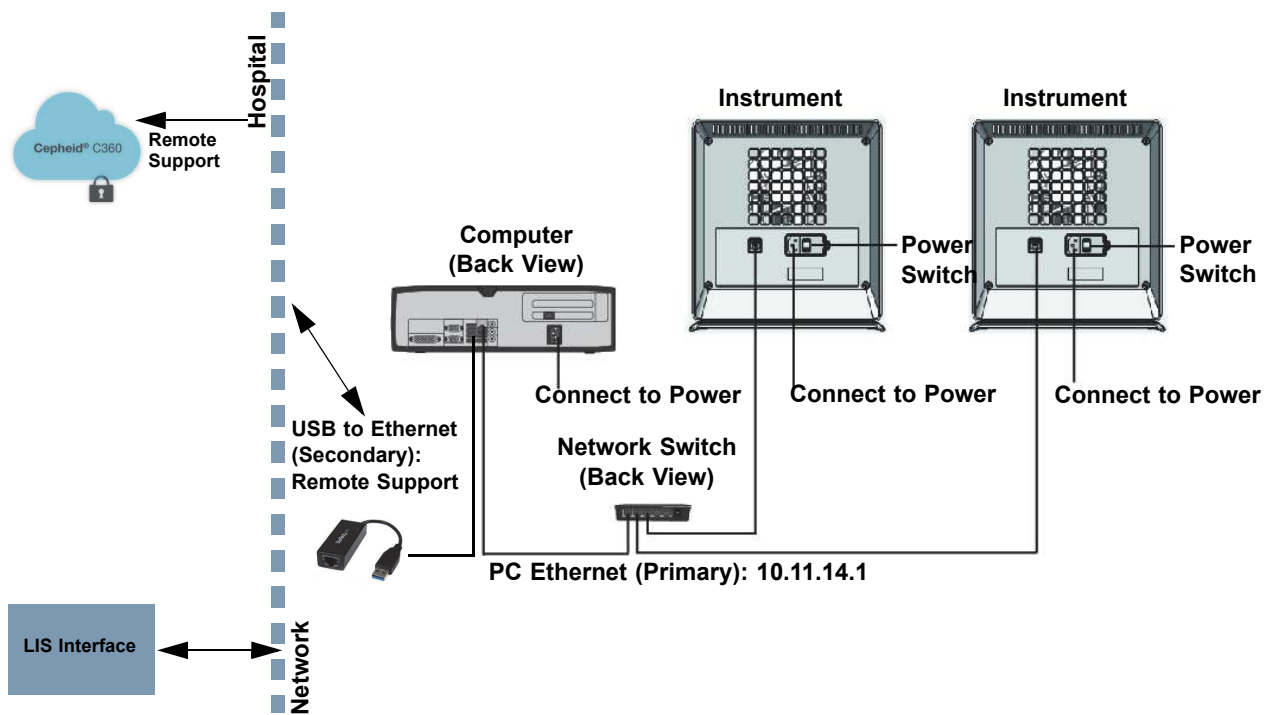

Figure 2-12. Connecting Multiple GX-IV Instruments to C360

2.6 Turning On the Computer

After the GeneXpert DX system computer has been installed, use the following procedure to turn the computer on and log onto the computer.

1. Turn on the GeneXpert Dx system computer following the computer manufacturer's instructions.
2. Wait for the system to boot.
 - On Windows 7, the Windows Account screen appears. See [Figure 2-13](#).
 - On Windows 10, the Windows Lock screen appears. See [Figure 2-14](#). Click anywhere on the screen to display the Windows Account and Password screen. See [Figure 2-16](#).
3. On the Windows Account screen, select the Cepheid user account (see [Figure 2-13](#) and [Figure 2-16](#)).
 - On Windows 7, the Windows Password screen appears. See [Figure 2-15](#).
 - On Windows 10, the Cepheid user account password field appears. See [Figure 2-16](#).

The GeneXpert Dx system computer is configured with two Windows accounts. The **Cepheid-Admin** account is for administrator tasks such as software updates, system configuration and normal operation; and the **Cepheid-Techsupport** account is for use only by Cepheid Technical Support. See [Figure 2-13](#) and [Figure 2-16](#).

Caution



You must be logged on using the preconfigured account. If you log on using a different user name and profile, the power management settings will be incorrect.



Figure 2-13. Windows 7 Account Screen

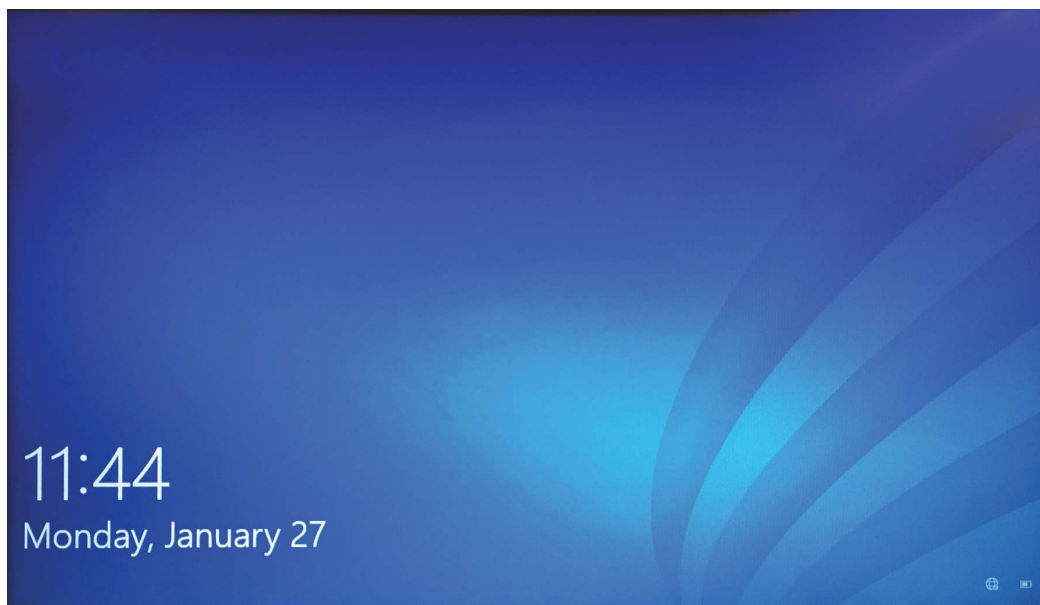

Figure 2-14. Windows 10 Lock Screen

The initial login password is provided below. You will be required to change the password upon first login. Do not change the user name or profile settings. When logging on, use the following:

- Account name: **Cepheid-Admin**
 - Password: **cphd**
4. On the Windows Password screen (see [Figure 2-15](#) and [Figure 2-16](#)), enter the password. The default password is **cphd** and must be changed upon initial login (as instructed by the software). After the password has been changed by the system administrator, enter the assigned password for future logins.



Figure 2-15. Windows 7 Password Screen

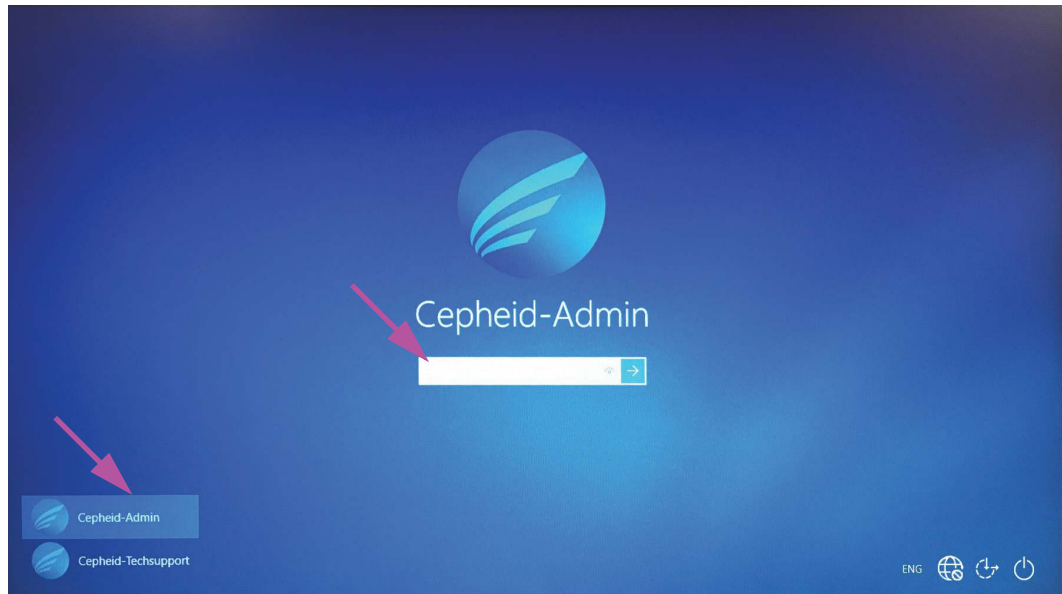

Figure 2-16. Windows 10 Account and Password Screen

Note

On the initial login to the GeneXpert system for the **Cepheid-Admin** account, after entering the **cphd** password, a prompt will be immediately displayed to change the password. Follow the on-screen instructions to change the password. Enter the old password (**cphd**) for the account then enter the new password two times. Remember to record and store the new password information in a safe location.

After the first login to the system, there will be no additional prompts to change the password.

Caution



Do not change the Cepheid user profile. Changing the profile can cause loss of data during a test.

5. The GeneXpert Dx software starts automatically on system startup. A GeneXpert Dx icon on the Windows desktop allows for manual software initiation. See [Figure 2-17](#).



Figure 2-17. GeneXpert Dx System Shortcut Icon

6. Exit the GeneXpert Dx software by clicking **Exit** under the File menu.

2.6.1 Anti-Virus Software

- For Windows 7, see [Section 2.6.1.1, Windows 7 Anti-Virus Software](#).
- For Windows 10, see [Section 2.6.1.2, Windows 10 Anti-Virus Software](#).

2.6.1.1 Windows 7 Anti-Virus Software

In order to protect the GeneXpert Dx system computer running Windows 7 from viruses that could cause data corruption or disrupt normal functionality, Cepheid strongly recommends installing and maintaining an updated anti-virus program. Computer viruses can be introduced by connecting the computer to a local or wide area network or from extracting data using external memory devices.

Cepheid has validated several commercially available off-the-shelf solutions from Symantec Corporation and McAfee Inc.

If the software is purchased from a commercial supplier, install the software by following the instructions in the user documentation provided with the software program chosen. Activation of the anti-virus software is usually accomplished by connecting to the Internet. Follow the specific activation instructions in the software dialog screens or documentation.

Note

The computer usually must be connected to the Internet to activate the anti-virus software. Be sure any updating is scheduled when no data is being collected.

If your institution requires the use of another type of anti-virus software other than the programs listed above, then the institution is responsible for validating the solutions compatibility with Cepheid product offerings.

Important

Maintain an active anti-virus subscription and download updates regularly. If the GeneXpert Dx system computer is used to access the Internet, run anti-virus software before resuming the use of the GeneXpert Dx software and confirm that the results from the system match the results output to any connected LIS.

Caution



The GeneXpert Dx system computer is set up to use Windows Firewall so the Windows firewall can remain turned on. Do not turn on or use other non-Windows firewall products. Doing so can prevent data collection.

Caution



Cepheid tests and qualifies our system components to provide optimal performance. Do not alter the computer settings, pre-installed software, or other system components unless instructed by Cepheid. Do not install non-approved software. Do not replace the system network connection.

2.6.1.2 Windows 10 Anti-Virus Software

The GeneXpert Dx system computer running Windows 10 ships with Windows Defender Antivirus to protect against viruses that could cause data corruption or disrupt normal functionality. Because Windows Defender Antivirus comes bundled with Windows 10 and is updated and maintained automatically with the operating system, Cepheid does not recommend using additional anti-virus software for the GeneXpert Dx system computer running Windows 10.

2.7 Disk Encryption (Windows 10)

Note

Before you begin, please keep in mind that encrypting your entire hard disk can be a long process. You will be able to use your computer while encryption takes place in the background, but you will eventually need to restart your computer. Save files frequently and plan accordingly.

BitLocker is an encryption system designed to prevent most offline attacks and malware. It is essential for you to use this feature to protect your data and keep confidential information secure. The procedure for Enabling BitLocker Drive Encryption in Windows 10 is included below.

Cepheid has validated BitLocker disk encryption on GeneXpert computers running Windows 10.

Customers are responsible for enabling BitLocker and setting the recovery key.

Note

If your computer includes a Trusted Platform Module (TPM), please skip to [Step 10](#). If your device does not include a Trusted Platform Module (TPM) chip, you will not be able to turn on BitLocker in Windows 10. You can still use encryption, but you will need to use the Local Group Policy Editor to enable additional authentication at startup. Start at [Step 1](#) below.

1. If you are using a tablet or touch screen device, switch to desktop mode.
2. Use the **Windows key + R** keyboard shortcut to open the Run command > type **gpedit.msc** > click **OK**.
3. Under Computer Configuration, expand **Administrative Templates**.
4. Expand **Windows Components**.
5. Expand **BitLocker Drive Encryption** and **Operating System Drives**.
6. On the right side, double-click **Require additional authentication at startup**.
7. Select **Enabled**.
8. Check the **Allow BitLocker without a compatible TPM (requires a password or a startup key on a USB flash drive)** option.
9. Click **OK** to complete this process.
10. Click **Start > File Explorer > This PC**.
11. Under **Devices and drives**, right-click your system drive (on touch screen devices, press and hold) where Windows 10 is installed, then click **Turn on BitLocker**.
12. Enter a password to unlock your drive. This is important to ensure you can boot the system even if you lose the recovery key.

Note

Cepheid recommends a password of 10 characters minimum with a combination of upper/lower case letters, numbers, and symbols.

Choose how to back up your recovery key:

- Save to your Microsoft account
- Save to a USB flash drive
- Save to a file (not to local hard drive)
- Print the recovery key

Important

If BitLocker is enabled, it is the customer's responsibility to maintain the recovery key if it is forgotten or misplaced. For more information, visit <https://www.microsoft.com>.

Cepheid suggests saving to a USB flash drive and printing the recovery key and archiving the recovery key with your IT department.

13. Choose how much of your drive to encrypt:

- Encrypt used disk space (faster and best for new PCs and drives)
- Encrypt entire drive (slower but best for PCs and drives in use)

Note

Cepheid recommends encrypting the entire drive.

- Choose which encryption mode to use:
- New encryption mode (best for fixed drives on this device)
- Compatible mode (best for drives that can be moved from this device)

Note

Cepheid recommends that you use the new encryption mode (XTS-AES) since drives do not move from computer to computer.

14. Check the box next to **Run BitLocker system check**.

15. Restart your computer.

16. When prompted, enter your password.

17. After logging into Windows 10, you can check the status of encryption

- Click **Start > File Explorer > This PC**
- You will now see a padlock emblem on the system drive.
- Right-click (press and hold) the drive then select **Manage BitLocker**
- You will see the current status which should be **C: BitLocker Encrypting**
- You can continue using your computer while encryption takes place in the background
- You will be notified when it is complete.

Once BitLocker Encryption is finished, all content and communications will be secured

2.8 Windows Language and Keyboard Configuration

The computer, as shipped, is configured for the English-language Windows software and keyboard. However, if language and keyboard settings need to be reconfigured to another language, refer to [Appendix C, GeneXpert Dx Software International Configuration Instructions](#).

2.9 Configuring the Computer

Note

GeneXpert Dx software version 6.2 supports Microsoft Windows 7 and Windows 10 operating systems. Should you need any assistance, please contact your regional Cepheid Technical Support center.

In this section, perform the following steps:

- Verify that the correct computer power management setting is selected to ensure proper operation of the system. See [Section 2.9.1, Power Management Settings](#).
- Set the computer date and time to ensure accurate time-stamping when the system is in use. See [Section 2.9.2, Local Date and Time](#).
- Check the IP address settings to ensure the proper operation of the system. See [Section 2.9.3, IP Address](#).

2.9.1 Power Management Settings

The computer is already configured with the correct power management settings. If it needs to be reset:

- For Windows 7, see [Section 2.9.1.1, Selecting the Power Management Settings on Windows 7](#).
- For Windows 10, see [Section 2.9.1.2, Selecting the Power Management Settings on Windows 10](#).

2.9.1.1 Selecting the Power Management Settings on Windows 7

1. On the Windows taskbar, click on the Windows icon.
2. Select **Control Panel**. If the view is set for Small icons, the All Control Panel Items window appears as shown in [Figure 2-18](#). Click on **Power Options**.

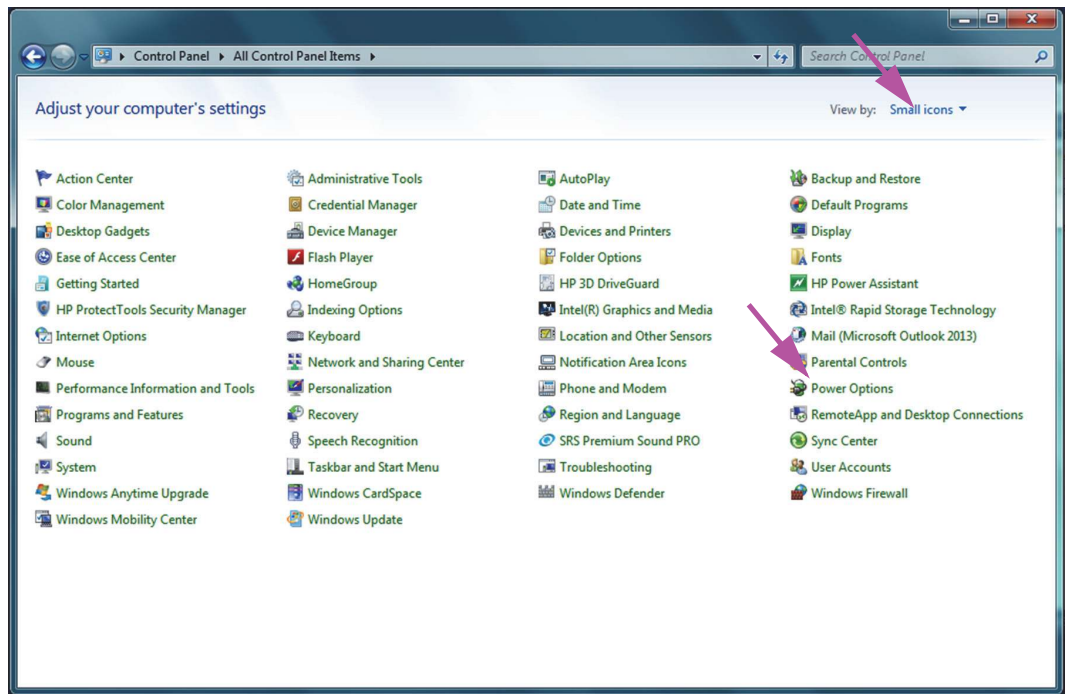

Figure 2-18. All Control Panel Items Window

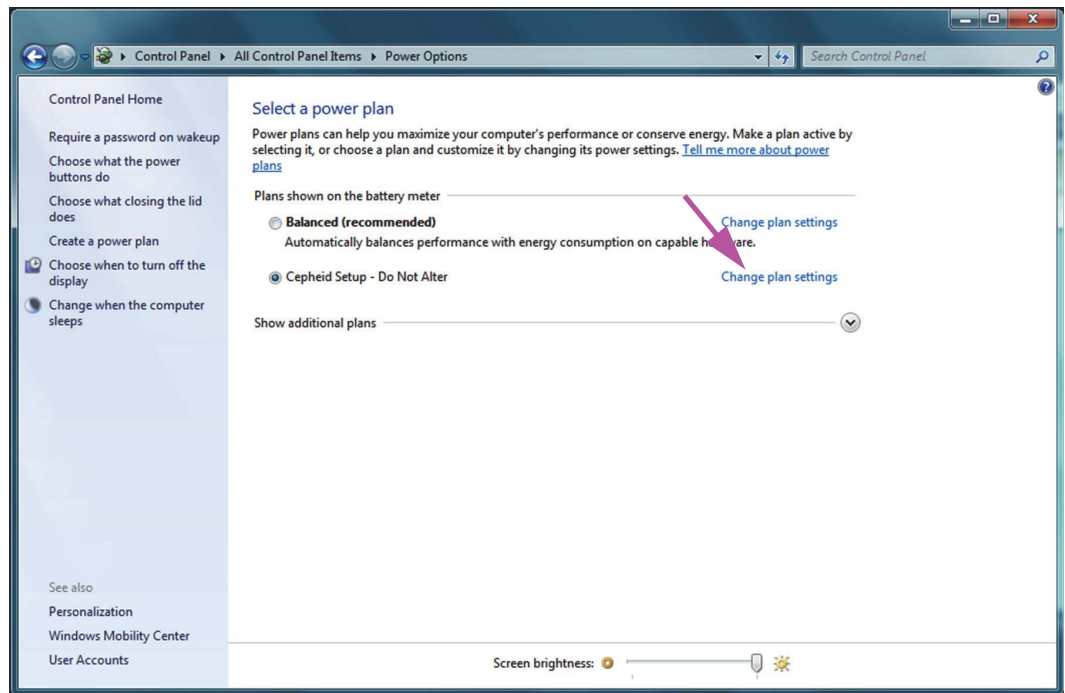

Figure 2-19. Power Options Window

3. Under the **Cepheid Setup—Do Not Alter** section, click **Change plan settings**. See Figure 2-19. The Edit Plan Settings windows appears. See Figure 2-20.

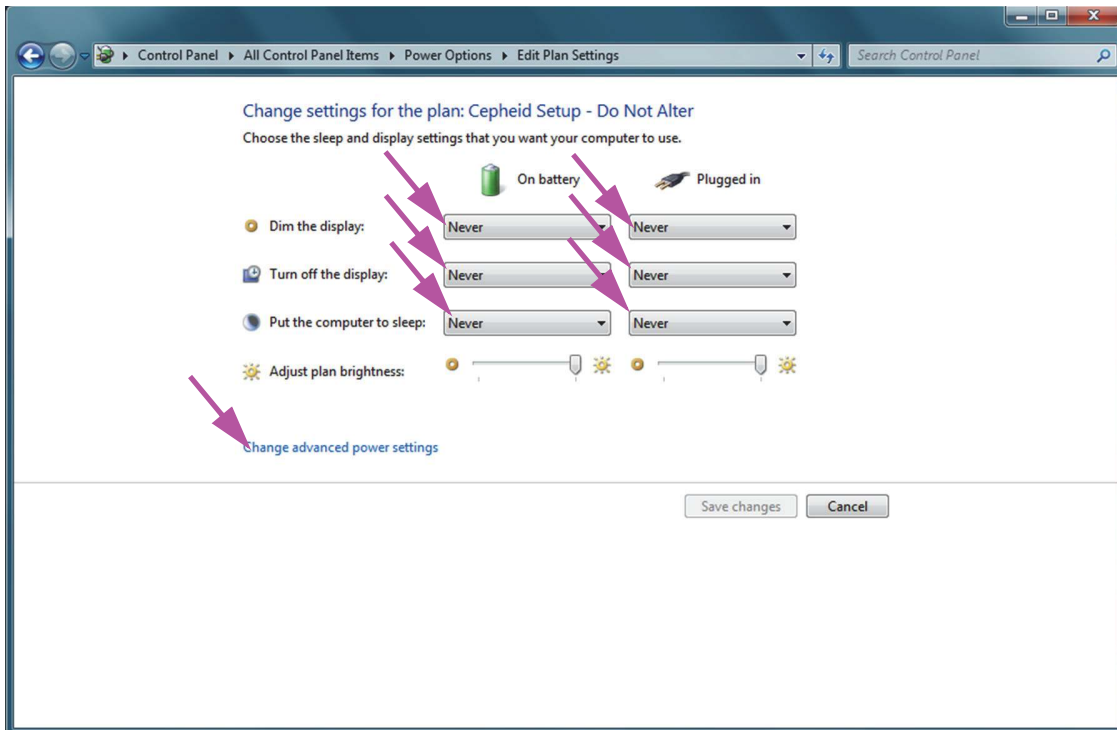

Figure 2-20. Edit Plan Settings Window

4. Make sure the **Dim the Display**, **Turn off the display** and **Put the computer to sleep** features are set to **Never** for both **On battery** and **Plugged in** options. See Figure 2-20.
5. Click on **Change advanced power settings** (see Figure 2-20). The Power Options Advanced settings window appears. See Figure 2-21.

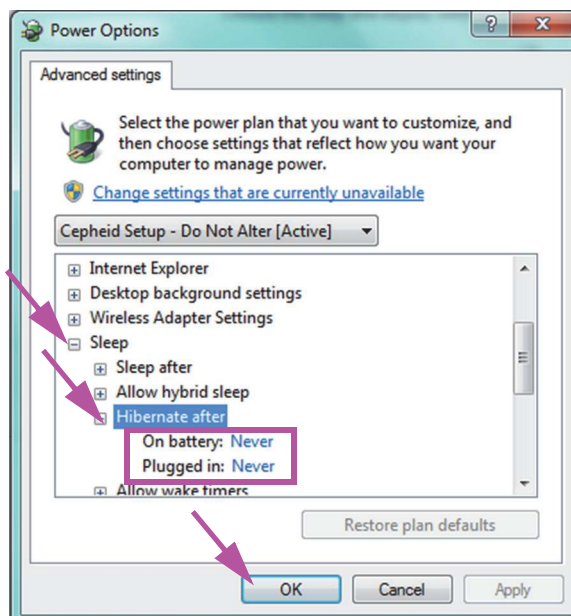

Figure 2-21. Power Options—Advanced settings Window

6. In the Power Options Advanced settings window, double-click **Sleep** to expand the view, and then double-click **Hibernate after**. See [Figure 2-21](#).
 - A. **Desktop Computers:** Verify that **Setting** value is set to zero (0) or **Never**. If not, change the **Setting** value to zero (0) or **Never**.
 - B. **Laptops Only:** Verify **On battery** and **Plugged in** values are set to **Never**. If not, click **ON battery** and/or **Plugged in**, and then use the up/down arrow keys to set their values to zero (0) on the selectable option.
7. Click **Apply** and then **OK** to close the Power Options window. The Edit Plan Settings window reappears.
8. Click **Cancel** to close the Edit Plan Settings window. The Power Options window appears (see [Figure 2-22](#)).
9. **Laptops Only:** On the Power Options window, click the **Choose what closing the lid does** entry. The System Settings window appears (see [Figure 2-23](#)). Set the **When I close the lid** setting to **Do nothing**, and set all other settings to **Sleep** and click **Save Changes**.

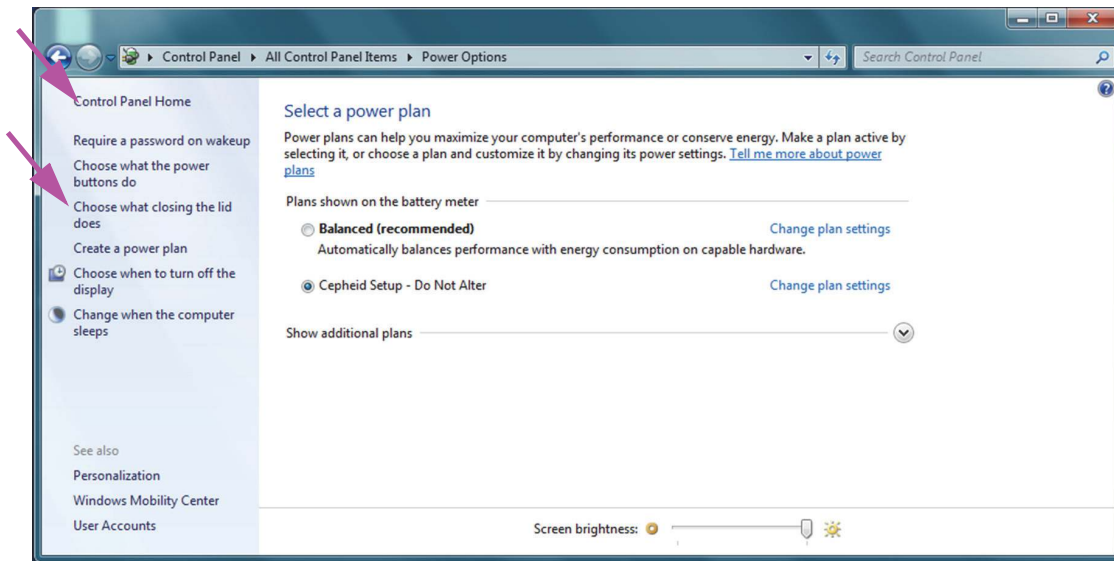

Figure 2-22. Power Options Window

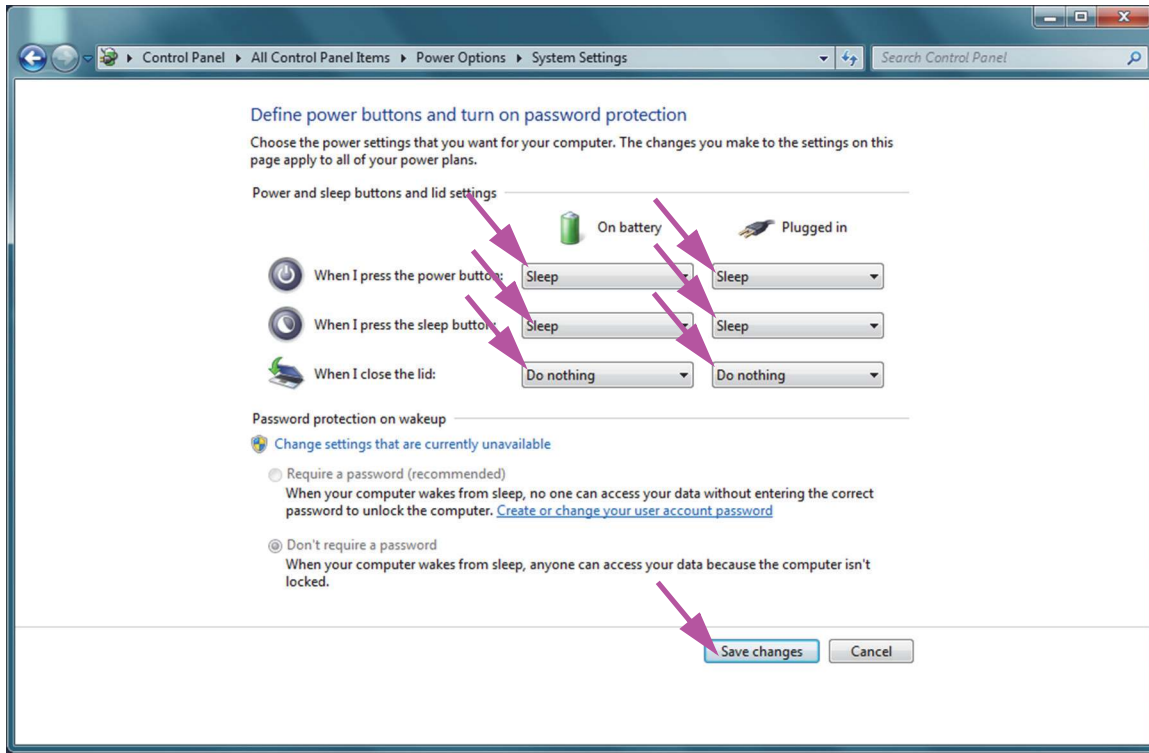

Figure 2-23. System Settings Window

10. **Laptops Only:** Click **Cancel** to close the Edit Plan Settings window. The Power Options window is displayed (see Figure 2-19).
11. Click the red **X** in the upper right-hand corner of the window to exit the Power Options settings and close the Control Panel window.

2.9.1.2 Selecting the Power Management Settings on Windows 10



1. On the Windows taskbar, click the Windows icon.
2. Select **Windows System > Control Panel**. If the view is set for Small icons, the All Control Panel Items window appears as shown in [Figure 2-24](#). Click on **Power Options**.

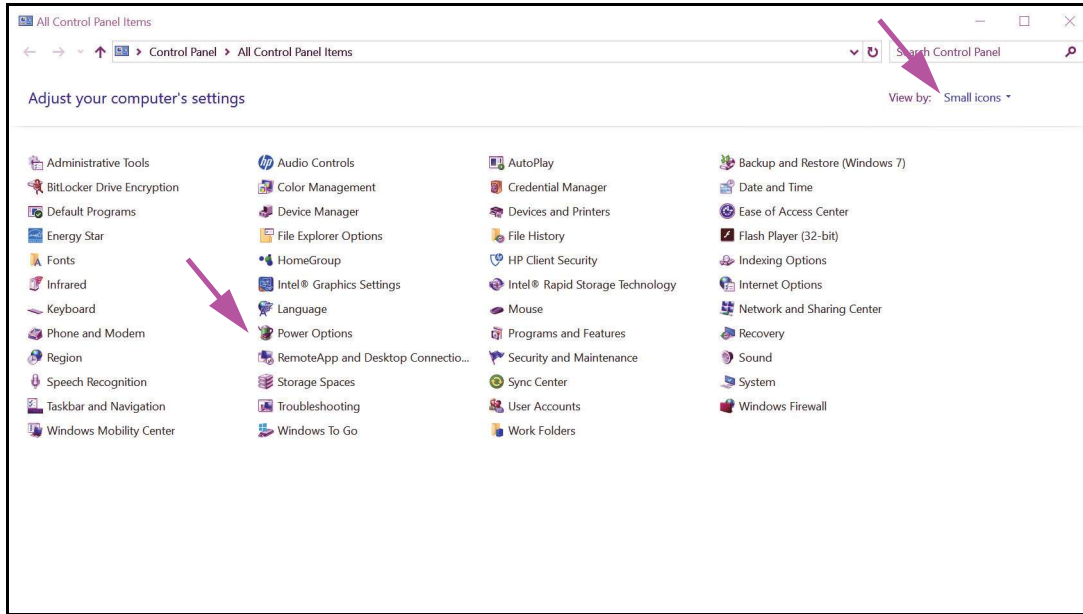

Figure 2-24. All Control Panel Items Window

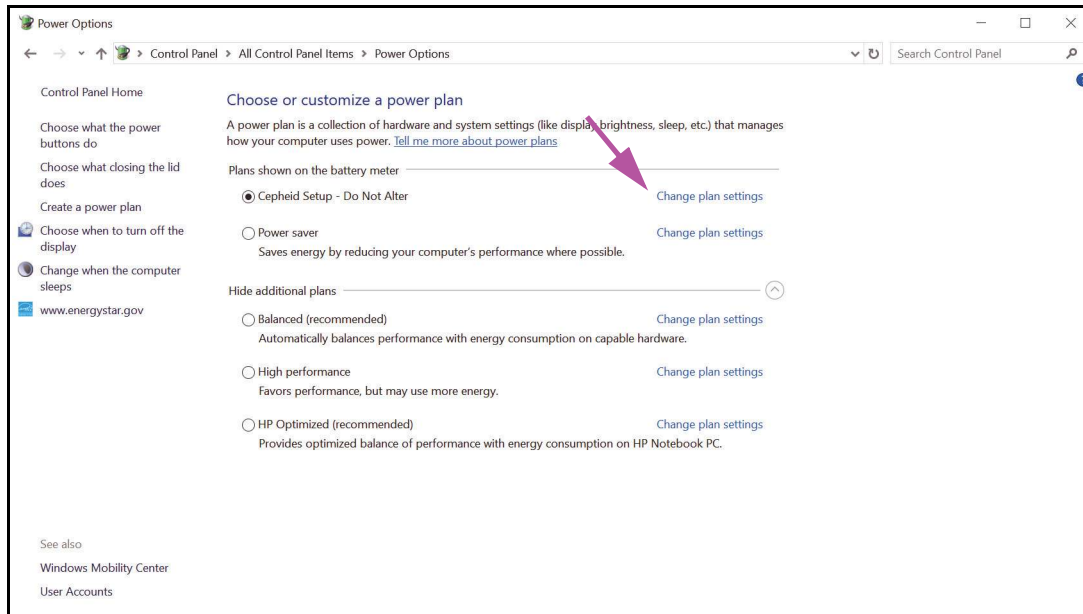

Figure 2-25. Power Options Window

3. Under the **Cepheid Setup—Do Not Alter** section, click **Change plan settings**. See [Figure 2-25](#). The Edit Plan Settings windows appears. See [Figure 2-26](#).

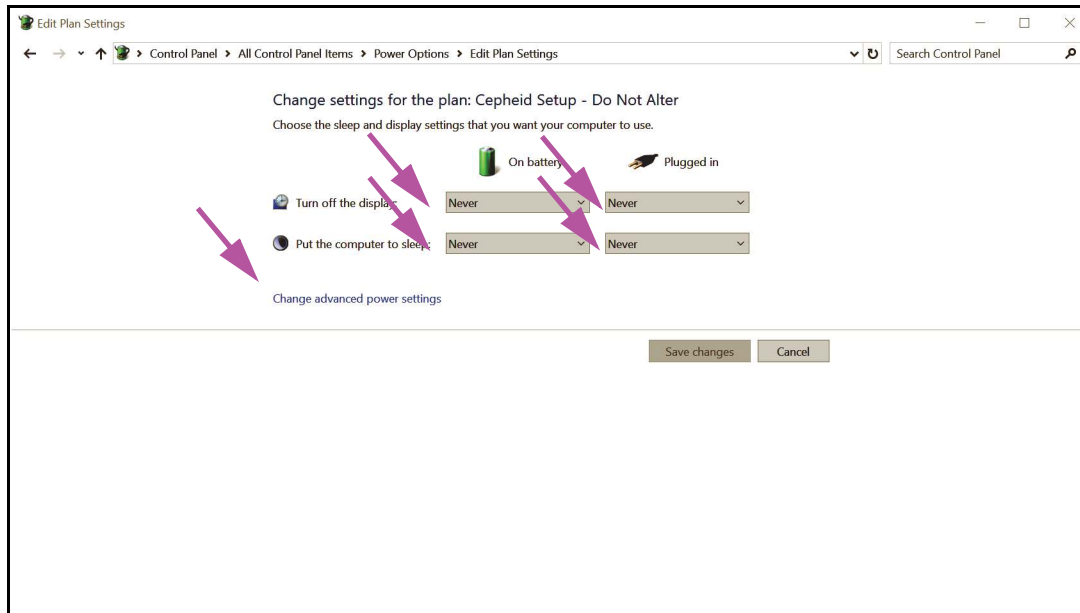

Figure 2-26. Edit Plan Settings Window

4. Make sure the **Turn off the display** and **Put the computer to sleep** features are set to **Never** for both **On battery** and **Plugged in** options. Also, make sure that the **Adjust plan brightness** feature slider is set to its brightest setting. See [Figure 2-26](#).
5. Click **Change advanced power settings** (see [Figure 2-26](#)). The Power Options Advanced settings window appears. See [Figure 2-27](#).

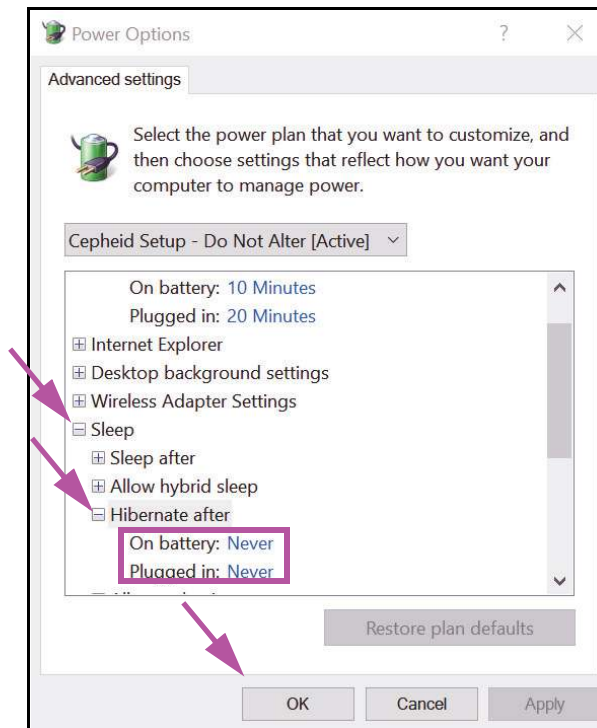

Figure 2-27. Power Options—Advanced settings Window (Sleep)

6. In the Power Options Advanced settings window, double-click **Sleep** to expand the view, and then double-click **Hibernate after**. See [Figure 2-27](#).
 - A. **Desktop Computers:** Verify that **Setting** value is set to zero (**0**) or **Never**. If not, change the **Setting** value to zero (**0**) or **Never**.
 - B. **Laptops Only:** Verify **On battery** and **Plugged in** values are set to **Never**. If not, click **On battery** and/or **Plugged in**, and then use the up/down arrow keys to set their values to zero (**0**) on the selectable option.
7. In the Power Options Advanced settings window, double-click **Display** to expand the view, and then double-click **Enable adaptive brightness**. See [Figure 2-28](#).
 - A. **Desktop Computers:** Verify that **Setting** value is set to **Off**. If not, change the **Setting** value to **Off**.
 - B. **Laptops Only:** Verify **On battery** and **Plugged in** values are set to **Off**. If not, change the **On battery** and/or **Plugged in** values to **Off**.

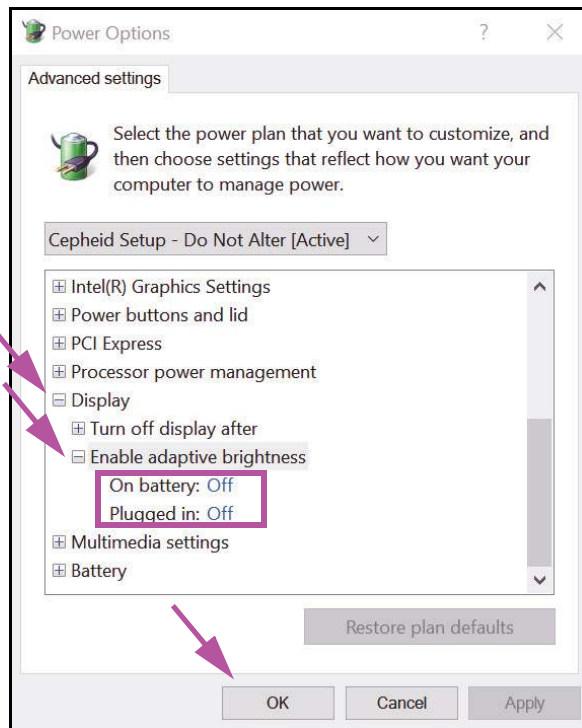

Figure 2-28. Power Options—Advanced settings Window (Display)

8. Click **Apply** and then **OK** to close the Power Options window. The Edit Plan Settings window reappears.
9. Click **Cancel** to close the Edit Plan Settings window. The Power Options window appears (see [Figure 2-29](#)).
10. **Laptops Only:** On the Power Options window, click the **Choose what closing the lid does** entry. The System Settings window appears (see [Figure 2-30](#)). Set all settings to **Do nothing** and click **Save Changes**.

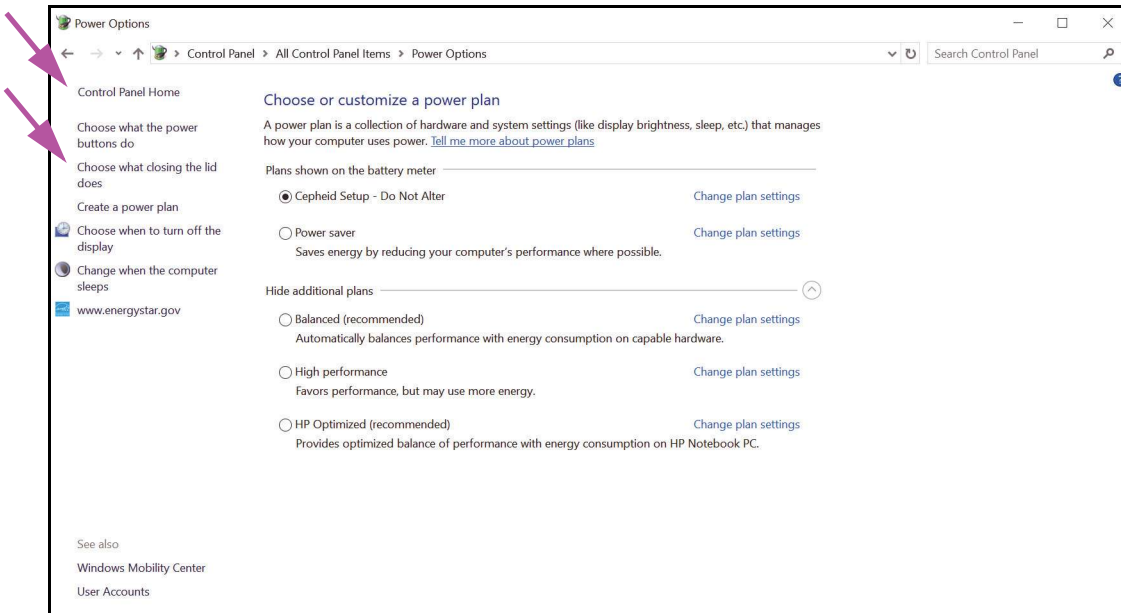

Figure 2-29. Power Options Window

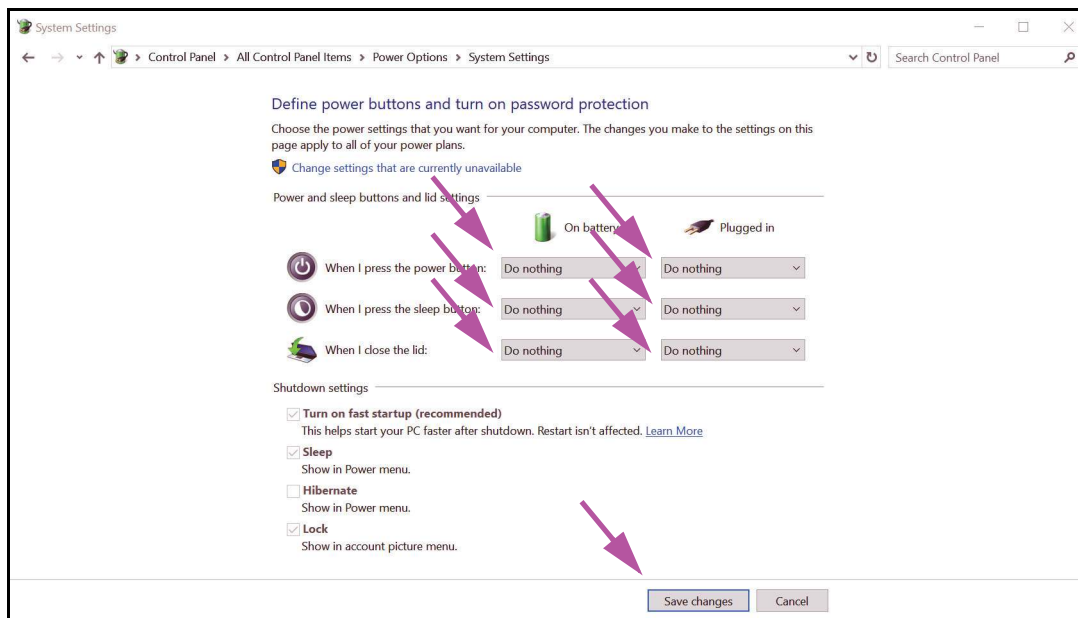

Figure 2-30. System Settings Window

11. **Laptops Only:** Click **Cancel** to close the Edit Plan Settings window. The Power Options window appears (see Figure 2-25).
12. Click the **X** in the upper right-hand corner of the window to exit the Power Options settings and close the Control Panel window.

2.9.2 Local Date and Time

To set the date and time:

- For Windows 7, see [Section 2.9.2.1, Setting the Local Date and Time on Windows 7](#).
- For Windows 10, see [Section 2.9.2.2, Setting the Local Date and Time on Windows 10](#).

2.9.2.1 Setting the Local Date and Time on Windows 7

1. Click **Control Panel > Date and Time**. The Date and Time dialog box appears. See [Figure 2-31](#).

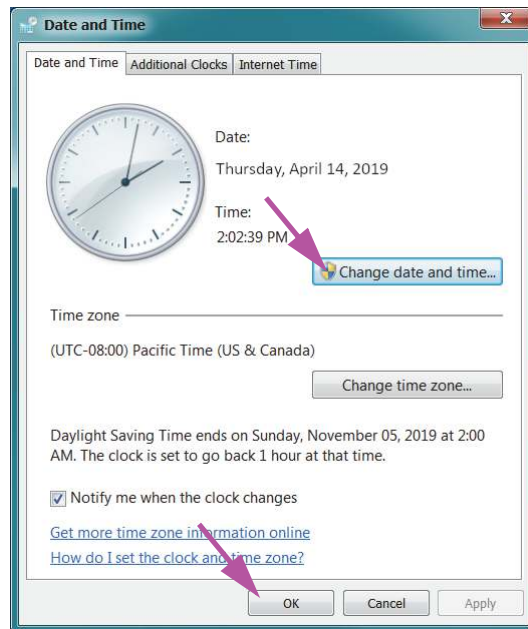

Figure 2-31. Date and Time Properties Dialog Box

2. Click the **Change Date and Time...** button. The Date and Time Settings dialog box appears. See [Figure 2-32](#).

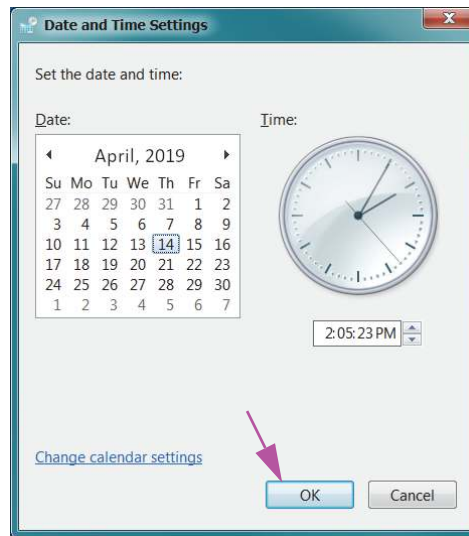

Figure 2-32. Date and Time Settings Dialog Box

3. Set the correct local date and time.
4. Click **OK** to return to the Date and Time dialog box. See Figure 2-31.
5. Click the **Change Time Zone...** button. The Time Zone Settings dialog box appears. See Figure 2-33.

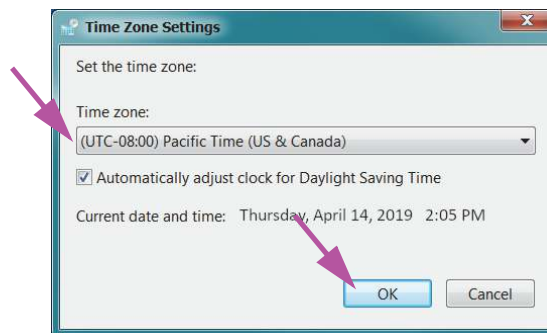

Figure 2-33. Time Zone Settings Dialog Box

6. Select the correct local time zone and check the **Automatically adjust clock for Daylight Saving Time** check box, if applicable.
7. Click **OK** to close the Time Zone Settings dialog box, and then click **OK** to close the Date and Time dialog box.

Caution



Do not change time or date settings when a test is in progress.

2.9.2.2 Setting the Local Date and Time on Windows 10

1. Click **Control Panel > Date and Time**. The Date and Time dialog box appears. See [Figure 2-34](#).

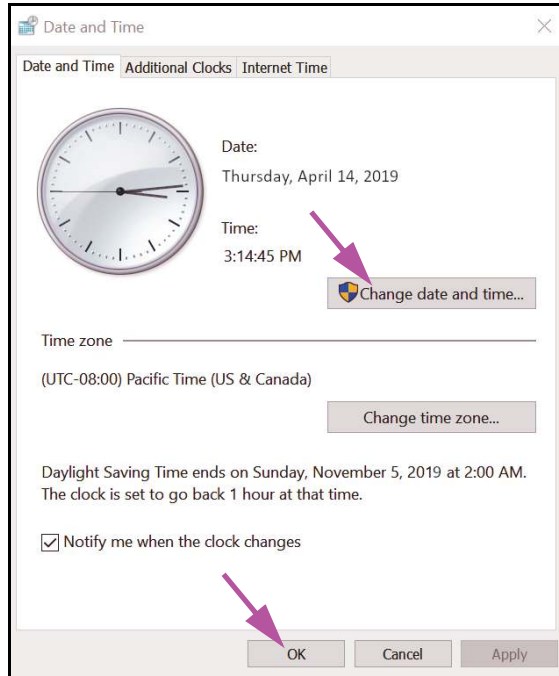

Figure 2-34. Date and Time Properties Dialog Box

2. Click the **Change Date and Time...** button. The Date and Time Settings dialog box appears. See [Figure 2-35](#).

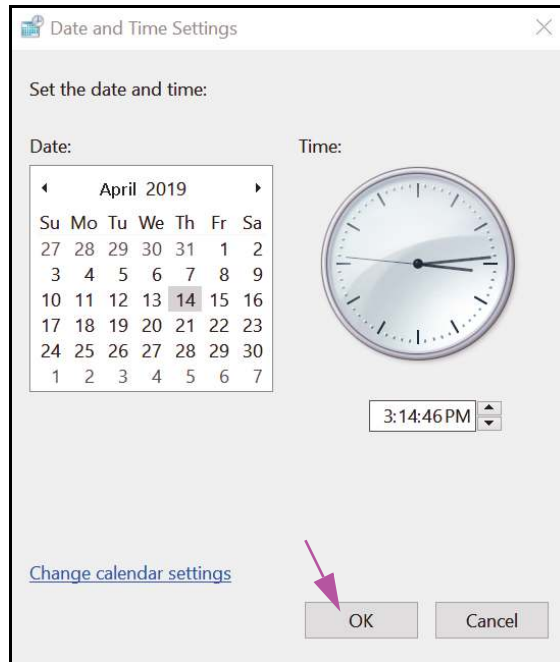

Figure 2-35. Date and Time Settings Dialog Box

3. Set the correct local date and time.
4. Click **OK** to return to the Date and Time dialog box. See [Figure 2-34](#).
5. Click the **Change Time Zone...** button. The Time Zone Settings dialog box appears. See [Figure 2-36](#).

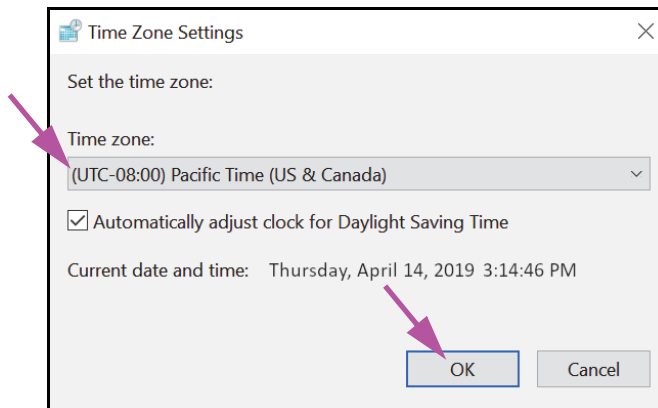

Figure 2-36. Time Zone Settings Dialog Box

6. Select the correct local time zone and check the **Automatically adjust clock for Daylight Saving Time** check box, if applicable.
7. Click **OK** to close the Time Zone Settings dialog box, and then click **OK** to close the Date and Time dialog box.

Caution

Do not change time or date settings when a test is in progress.

2.9.3 IP Address

Note

To perform the steps in this section, you must either be logged on as **Cepheid-Admin** or you need to enter the **Cepheid-Admin** password.

The computer is already configured with the correct IP address when the GeneXpert Dx system is shipped. If it needs to be reset:

- For Windows 7, see [Section 2.9.3.1, Setting the IP Address on Windows 7](#).
- For Windows 10, see [Section 2.9.3.2, Setting the IP Address on Windows 10](#).

2.9.3.1 Setting the IP Address on Windows 7

1. Log onto the system as **Cepheid-Admin** or enter the **Cepheid-Admin** password when requested to do so.
2. On the Windows taskbar, click the **Windows** icon.
3. Select **Control Panel**. If the view is set for **Category**, the screen appears as shown in [Figure 2-37](#).

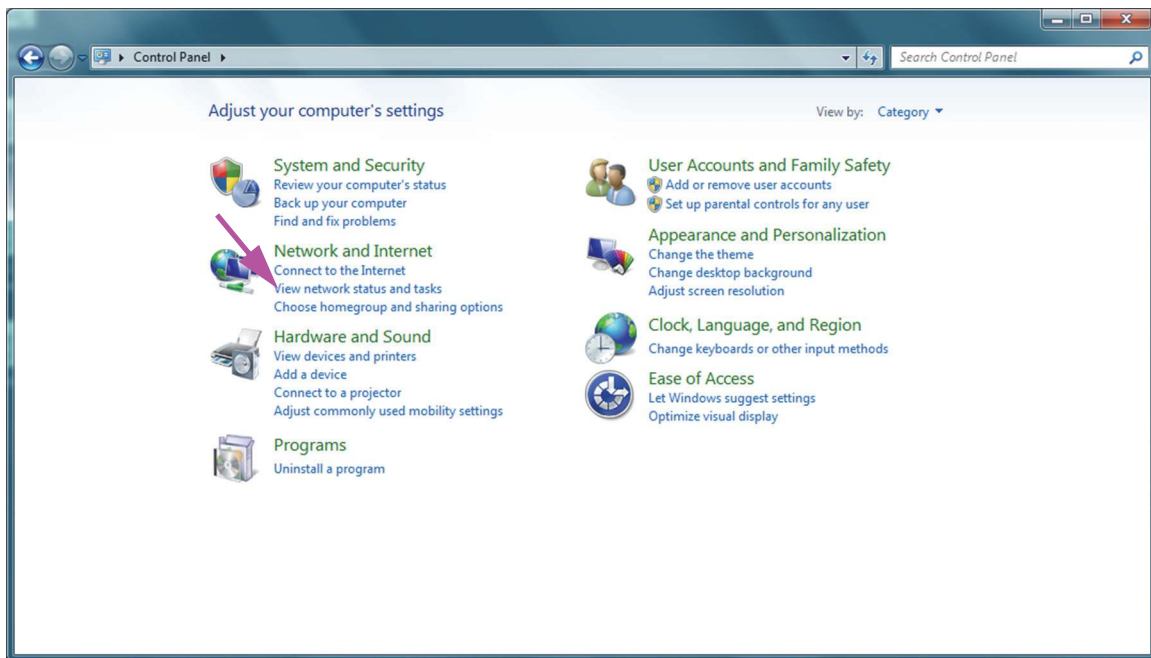

Figure 2-37. All Control Panel Items Window—Category View

4. Click **View network status and tasks**. The **Network and Sharing Center** screen appears. See [Figure 2-38](#).

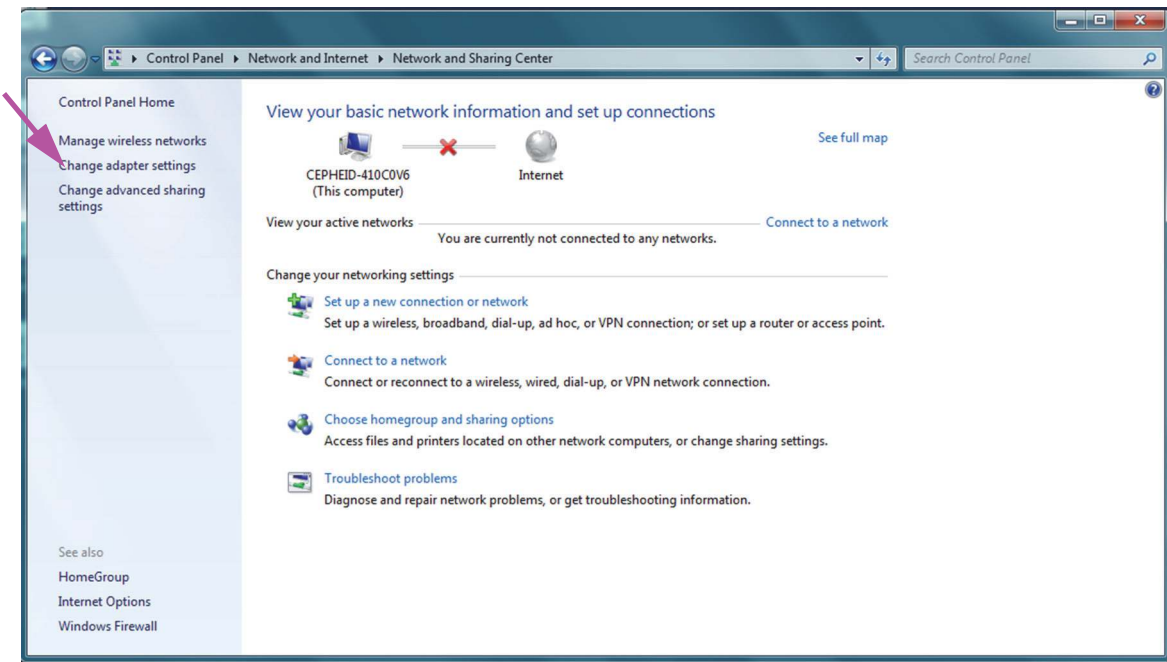

Figure 2-38. Network and Sharing Center Screen

5. Click **Change adapter settings**. The Network Connections screen appears. See [Figure 2-39](#).

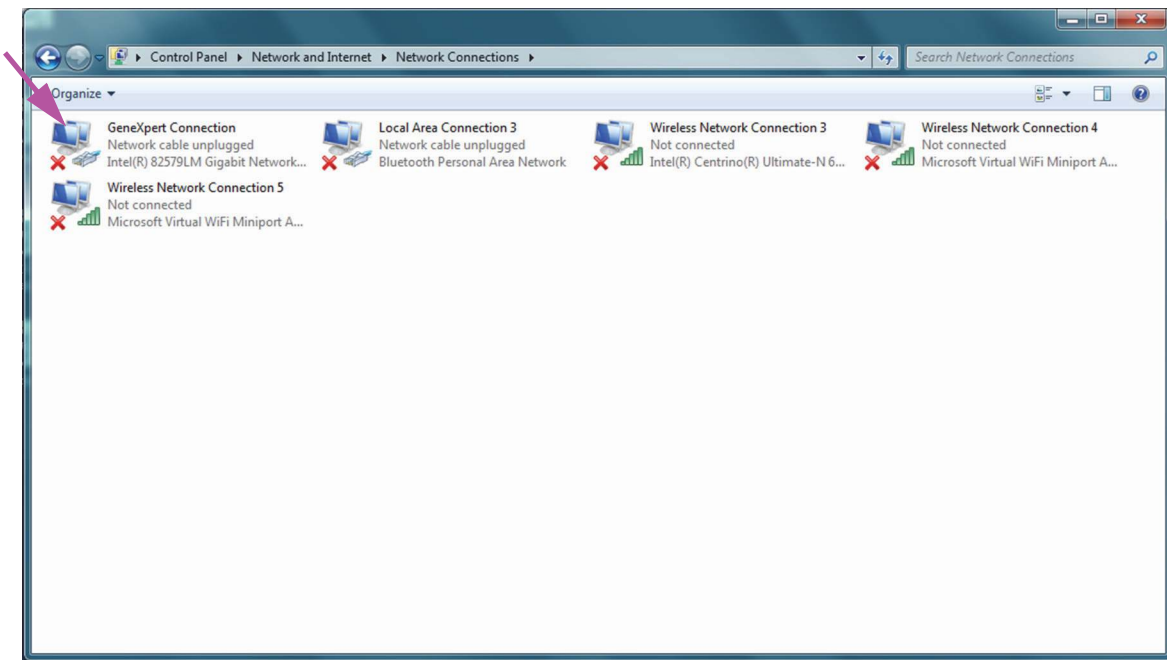

Figure 2-39. Network Connections Screen

- Right click the **GeneXpert Connection** entry. A drop-down menu appears. See [Figure 2-40](#).

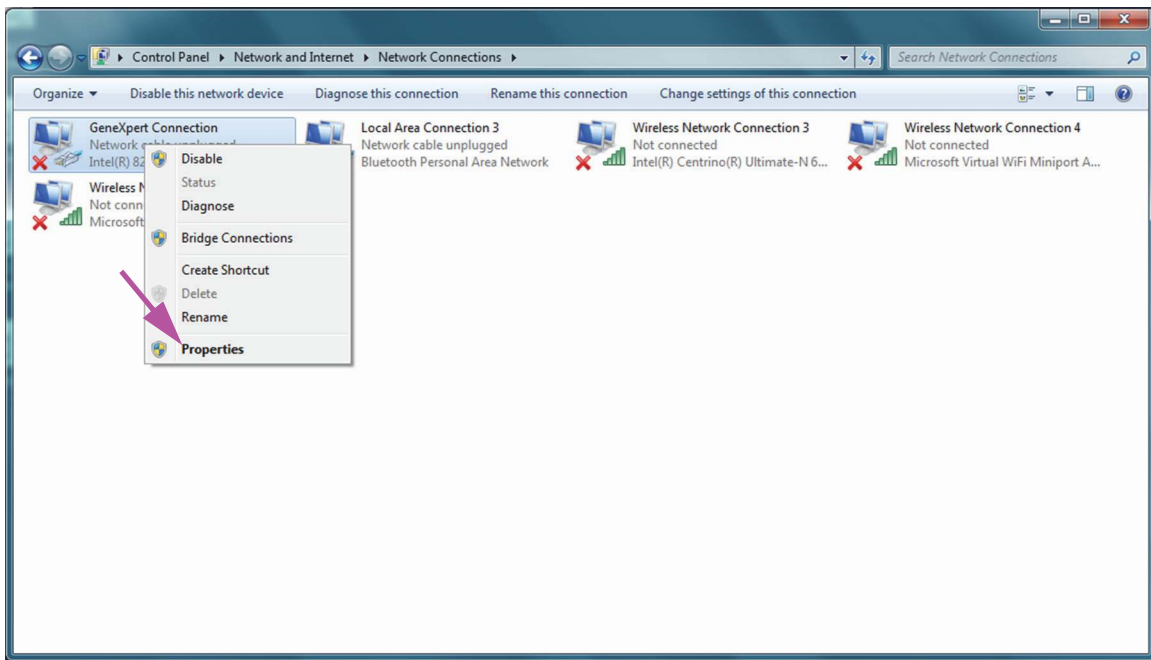

Figure 2-40. Network Connections Screen with Drop-Down Menu

- Select **Properties** from the drop-down menu. The screen shown in [Figure 2-41](#) is displayed.

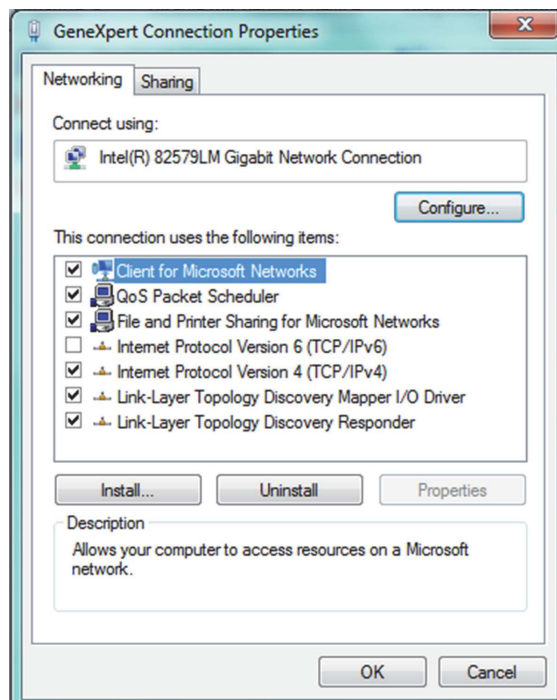

Figure 2-41. GeneXpert Connection Properties Screen

- On the GeneXpert Connection Properties Screen (shown in [Figure 2-42](#)) uncheck the box next to **Internet Protocol Version 6 (TCP/IPv6)**. Highlight **Internet Protocol Version 4 (TCP/IPv4)**, and then click **Properties**. The Internet Protocol Version 4 (TCP/IPv4) Properties screen appears.

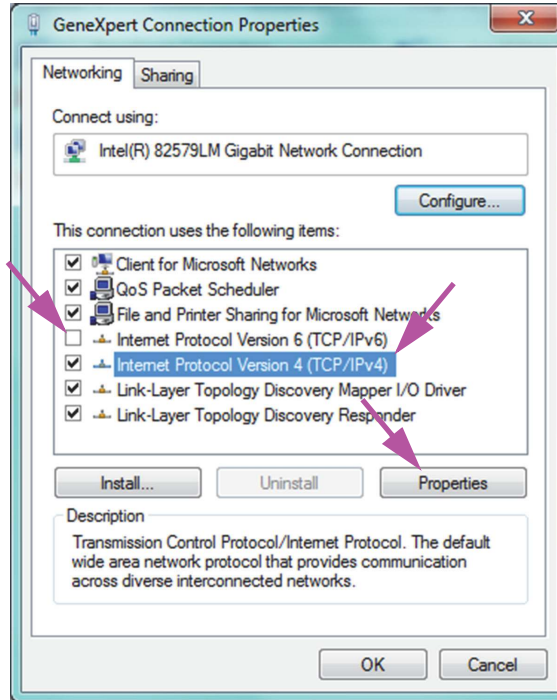

Figure 2-42. GeneXpert Connection Properties Screen

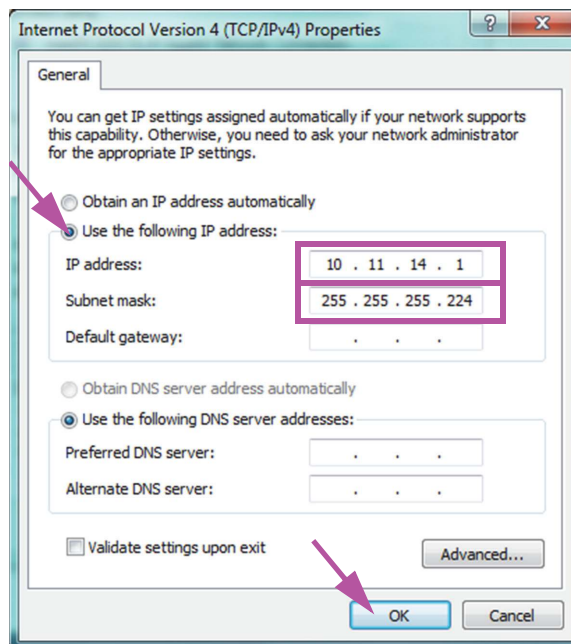

Figure 2-43. Internet Protocol Version 4 (TCP/IPv4) Properties Screen

- On this screen, select **Use the following IP address:**. See [Figure 2-43](#).

10. Enter:
 IP Address: **10 . 11 . 14 . 1**
 Subnet Mask: **255 . 255 . 255 . 224**
11. After you have verified that all numbers are entered correctly, click **OK** to close the GeneXpert Connection Properties window.
12. Click **Close** to close the GeneXpert Connection Properties window.
13. Click the **X** in the upper right corner of the window to close the Control Panel window.
14. If you were logged into the **Cepheid-Admin** account at the beginning of this configuration section, then you must log off that account.

2.9.3.2 Setting the IP Address on Windows 10

1. Log onto the system as **Cepheid-Admin** or enter the **Cepheid-Admin** password when requested to do so.
2. On the Windows taskbar, click the **Windows** icon.
3. Select **Control Panel**. If the view is set for **Category**, the screen appears as shown in [Figure 2-44](#).

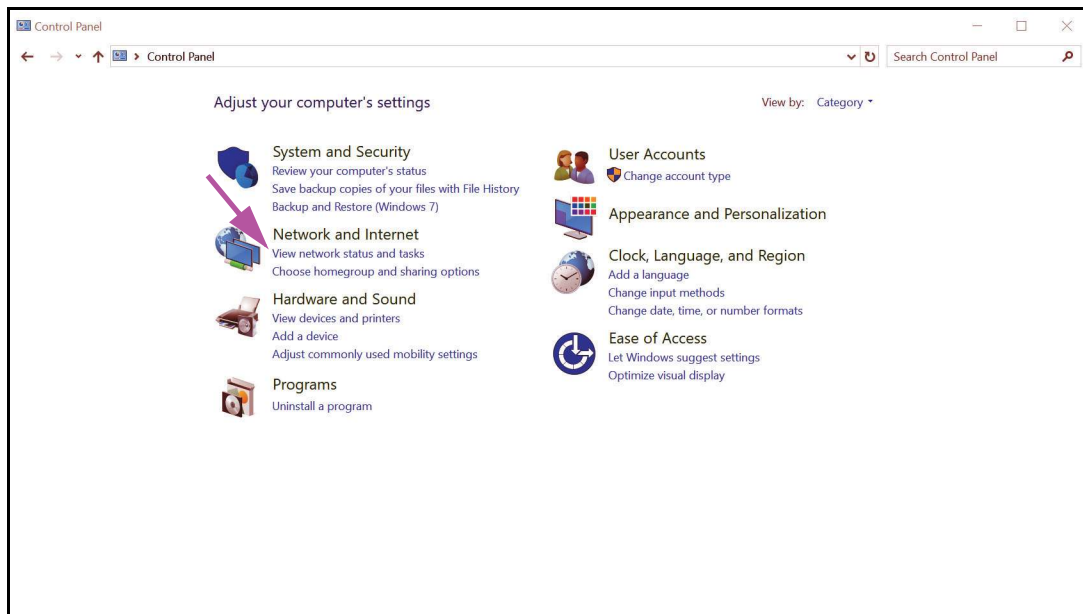

Figure 2-44. All Control Panel Items Window—Category View

4. Click **View network status and tasks**. The **Network and Sharing Center** screen appears. See [Figure 2-45](#).

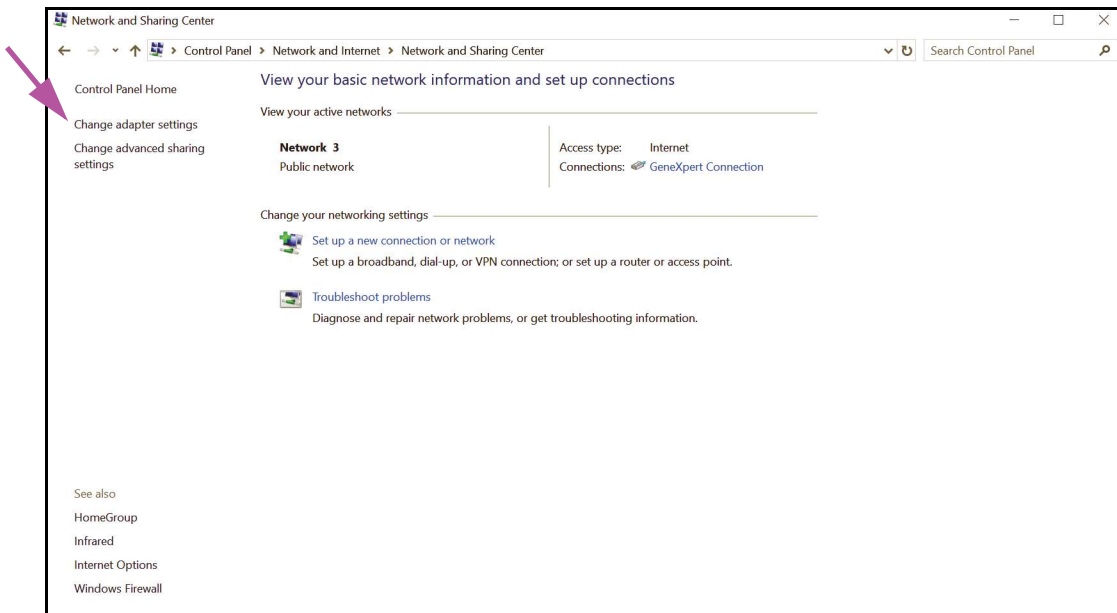

Figure 2-45. Network and Sharing Center Screen

5. Click **Change adapter settings**. The Network Connections screen appears. See [Figure 2-46](#).

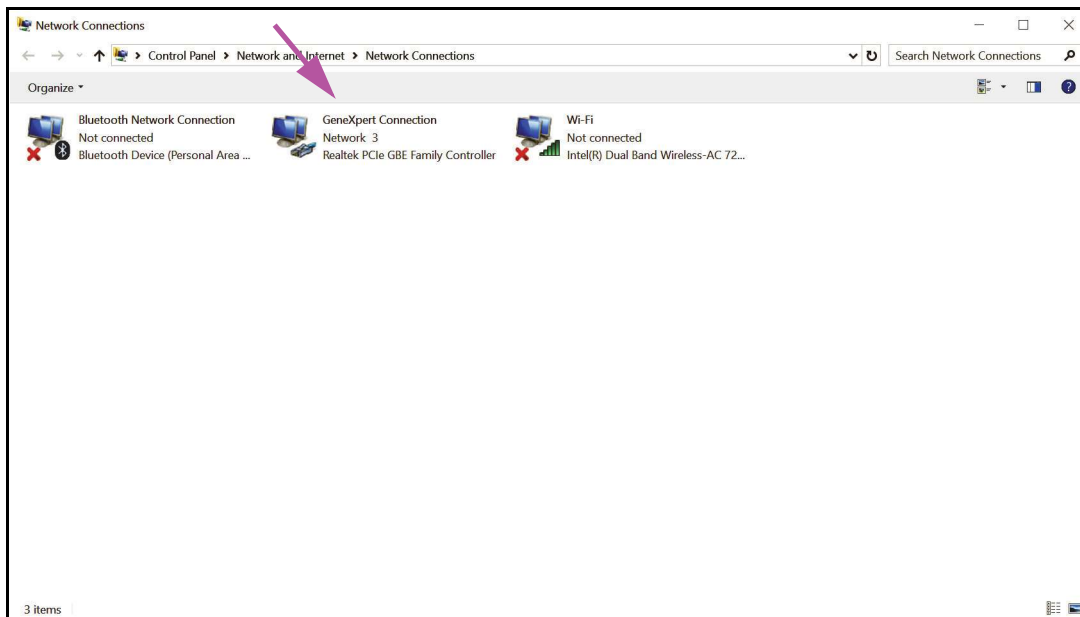

Figure 2-46. Network Connections Screen

6. Right click the **GeneXpert Connection** entry. A drop-down menu appears. See [Figure 2-47](#).

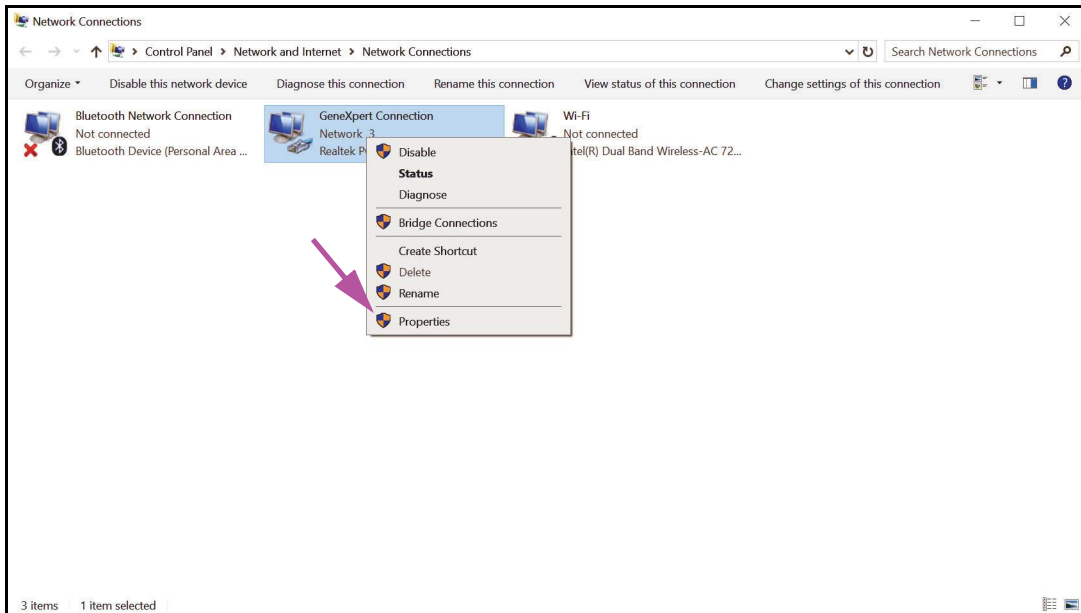

Figure 2-47. Network Connections Screen with Drop-Down Menu

7. Select **Properties** from the drop-down menu. The screen shown in [Figure 2-48](#) is displayed.

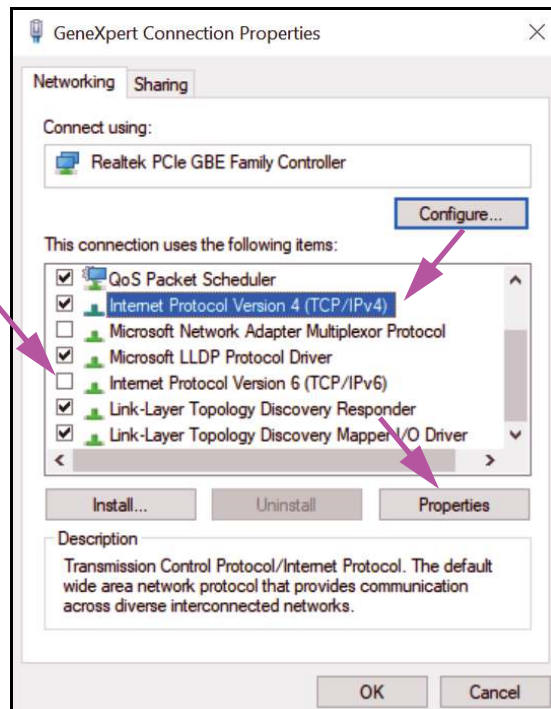

Figure 2-48. GeneXpert Connection Properties Screen

- On the GeneXpert Connection Properties Screen (shown in [Figure 2-48](#)) uncheck the box next to **Internet Protocol Version 6 (TCP/IPv6)**. Highlight **Internet Protocol Version 4 (TCP/IPv4)**, and then click **Properties**. The Internet Protocol Version 4 (TCP/IPv4) Properties screen appears.

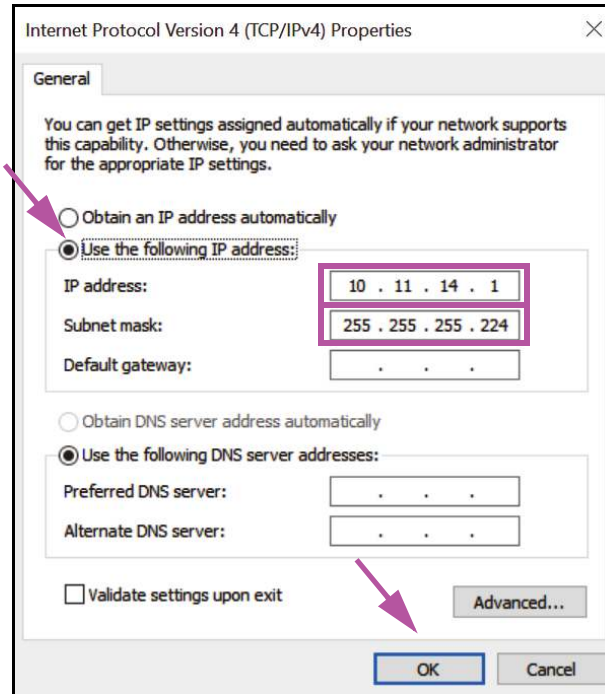

Figure 2-49. Internet Protocol Version 4 (TCP/IPv4) Properties Screen

- On this screen, select **Use the following IP address:**. See [Figure 2-49](#).
- Enter:
IP Address: **10 . 11 . 14 . 1**
Subnet Mask: **255 . 255 . 255 . 224**
- After you have verified that all numbers are entered correctly, click **OK** to close the GeneXpert Connection Properties window.
- Click **Close** to close the GeneXpert Connection Properties window.
- Click the **X** in the upper right corner of the window to close the Control Panel window.
- If you were logged into the **Cepheid-Admin** account at the beginning of this configuration section, then you must log off that account.

2.10 Controlling Windows 10 Automatic Updates

Windows 10 has been designed by Microsoft to have continuous automatic updates. Cepheid has found that during the subsequent restart, tests in progress may possibly be lost.

Recommendation: Change the group policy so that the customer can control when to download and install OS patches.

Note

If your IT department joins the GeneXpert computer to your company's network (aka your Active Directory, LDAP, domain), then the following changes may get overridden. Please be sure to inform your IT of the recommended changes below.

Note

This change will not impact your Windows Defender anti-virus updates.

Note

Please make this change at a time when tests are not running.

1. Press the Windows key and type **Group Policy Editor**.
2. Double-click **Computer Configuration -> Administrative Templates -> Windows Components -> Windows Update**.
3. Double-click **Configure Automatic Updates**.
4. Select **Enabled**.
5. Select: **2 - Notify for download and auto-install**.
6. Click the **Apply** button.
7. Click the **Previous Setting** button.
User should be on Configure auto-restart required notification for updates.
8. Select **Enabled**.
9. Select **2 – User Action**.
10. Click the **Apply** button.
11. Click the **OK** button.
12. Close the **Group Policy Editor** window.
13. Restart the computer for the changes to take effect.

Reference - <https://docs.microsoft.com/en-us/windows/deployment/update/waas-wu-settings#configure-automatic-updates>

Confirm changes

1. Click on **Start**, click on **Settings** (Gear icon).
2. Click on **Update and Security**.
3. User will be able to see this message “**Some settings are managed by your organization**”.
4. User will be able to see **Updates available**’.
5. User will be able to download and install updates during their scheduled weekly maintenance periods when tests are not running.

2.11 Starting the Software for the First Time

Turn on the GeneXpert instrument(s). The small blue light on the front of the instrument will turn on.

Note

The GeneXpert instrument must be powered up before the GeneXpert software is started. If the instrument is not powered up first, it will not be recognized by the software.

After installing the system and setting up the computer, the GeneXpert Dx application software will start automatically upon logging into the **Cepheid** or **Cepheid-Admin** user accounts.

The first time the software starts, a user name and password do not have to be provided. After defining the administrator profile (see [Section 2.13, Defining Users and Permissions](#)), the software will ask for a user name and password each time the software is started (see [Section 5.2.3, Starting the Software](#)).

As the software is starting, the green light above each module door flashes briefly, then turns off.

The first time the software starts after installation, an Assign Instrument Letter confirmation dialog box appears (see [Figure 2-51](#)).

Note

After automatic instrument letter assignment, and every time the software starts thereafter, the GeneXpert Dx System window appears without the Assign Instrument Letter confirmation dialog box. You will, however, see the assign instrument letter dialog box if you connect a new instrument and then launch the software.

Note

Whenever you exit the GeneXpert Dx application without powering down the computer, you must double-click the **GeneXpert Dx** icon to restart the application.

Important

Do not load any new version of Microsoft SQL applications.

1. Start the GeneXpert Dx software:
 - On the Windows desktop, double-click the **GeneXpert Dx** icon (see [Figure 2-50](#)).



Figure 2-50. GeneXpert Dx System Shortcut Icon

OR

- On the Windows taskbar, click the **Start** icon, and select **All Programs > Cepheid > GeneXpert Dx**.

The GeneXpert Dx System window appears. See [Figure 2-51](#).

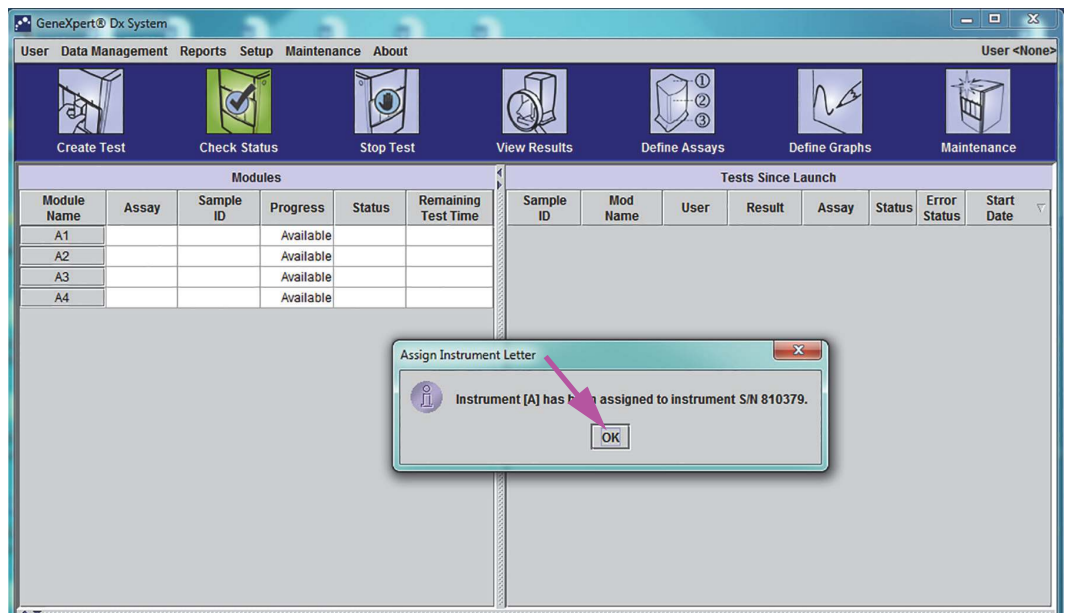

Figure 2-51. GeneXpert Dx System Window

Note The GeneXpert Dx software runs on Windows 7 and Windows 10. The screens shown in this manual are from GeneXpert Dx software running on Windows 7. Screens for GeneXpert Dx software running on Windows 10 will be similar.

Note An update overlay screen may appear, stating **Updating module firmware**. This updating process must complete before you can proceed.

2. The Assign Instrument Letter overlay appears, indicating the automatic assigning of the instrument(s) has completed. To continue, click **OK** to acknowledge this action and close the dialog box.

3. After the Assign Instrument Letter box closes, the database management dialog box (previously hidden by the Assign Instrument Letter overlay) becomes visible. Click **No** on the Database Management dialog box to proceed.

Note Since this is the initial startup of the software, there are no database management tasks to perform.

2.12 Assigning Instrument Letters

2.12.1 To Assign Instrument Letters (GX-I, GX-II and GX-IV Instruments)

Note This section describes tasks that only the GeneXpert Dx system administrator and users with the appropriate privileges can perform.

The first time the software starts after installation, the software will automatically assign instrument letters. By default, the software automatically assigns a letter (A, B, etc.) to identify each instrument connected to the computer. In addition, the software also assigns a number (1, 2, 3 or 4) to each module that is installed, from left to right. For example, A1 is the first or left-most module of the A instrument. The instrument and module identification appears in the **Module Name** column in all the software windows. See [Figure 2-52](#).

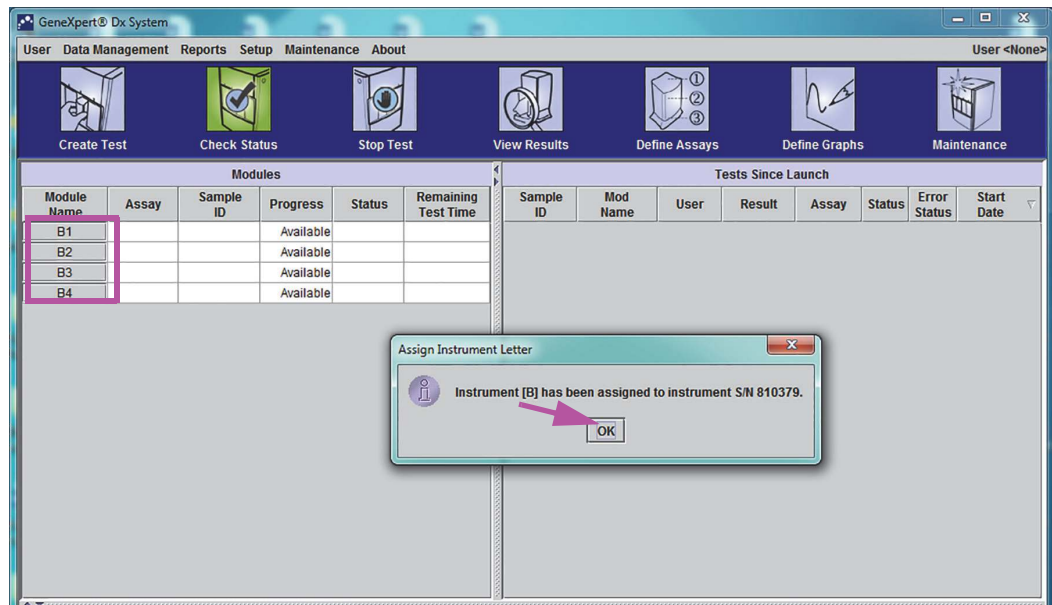

Figure 2-52. GeneXpert Dx System Window with Assign Instrument Letter Dialog Box Overlay

1. In the Assign Instrument Dialog box, click **OK** to acknowledge the assignment of the instrument letter(s), which closes the dialog box. The Database Management dialog box appears (see [Figure 2-53](#)).

Note

You will have an opportunity to change the instrument letter assignment later in this section, if needed.

Note

The examples in this section shows how to change instrument letter “B” to “A.”

2. In the Database management dialog box, click **NO** to proceed.
3. In the Test Archive Reminder box, click **NO** to proceed (see [Figure 2-54](#)). The GeneXpert Dx System screen appears (see [Figure 2-55](#)).

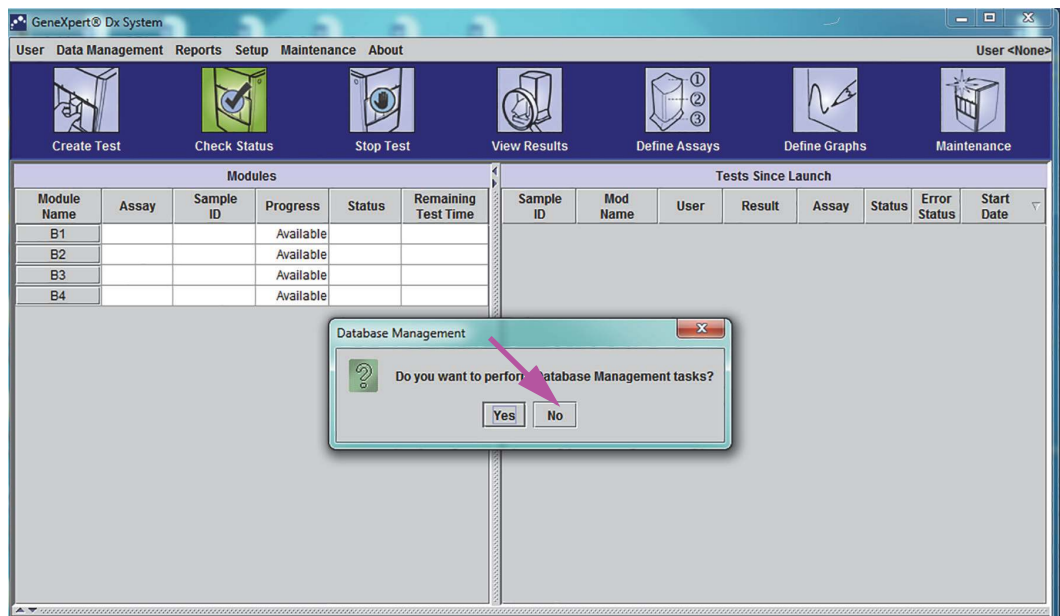

Figure 2-53. GeneXpert Dx System Window with Database Management Dialog Box Overlay

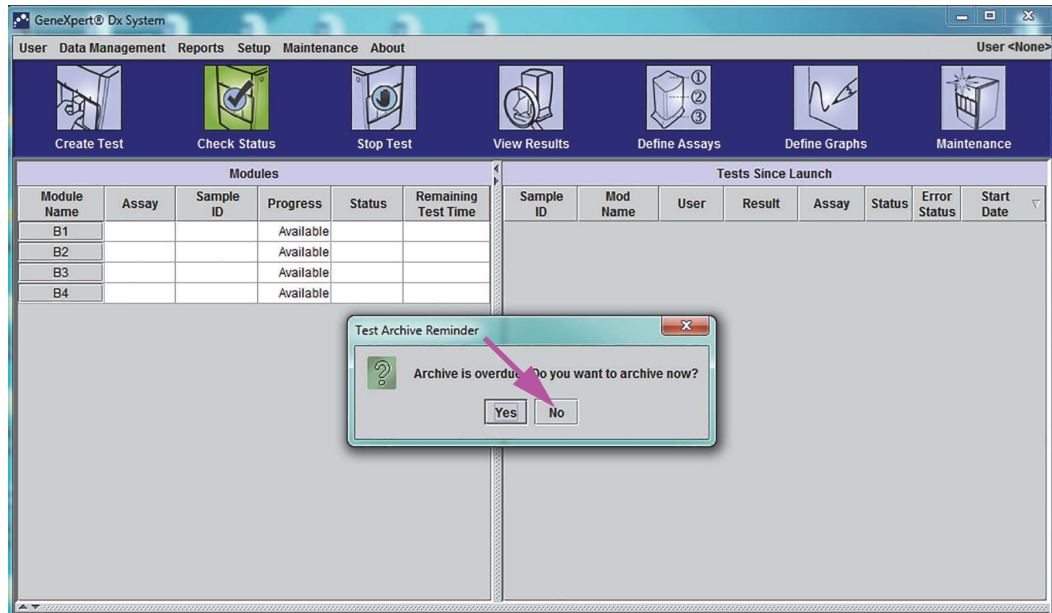

Figure 2-54. GeneXpert Dx System Window with Test Archive Reminder Dialog Box Overlay

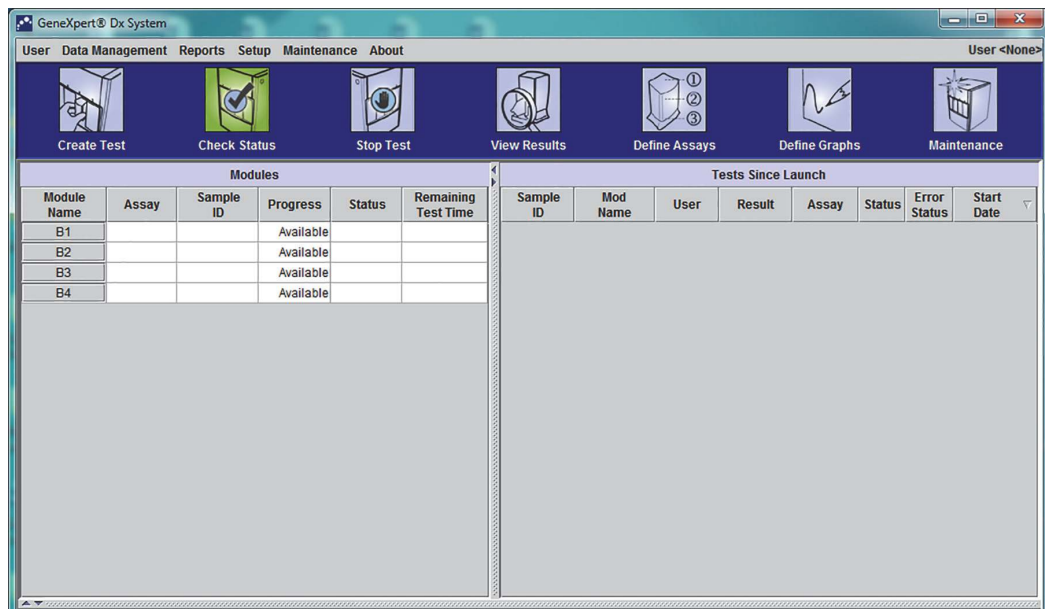

Figure 2-55. GeneXpert Dx System Window

- In the GeneXpert Dx System window, click **Setup** in the menu bar, and then select **Assign Instrument Letter**. The Assign Instrument Letter dialog box appears. See [Figure 2-56](#). At the same time, the green LED indicators of four modules that comprise the selected quadrant will flash.

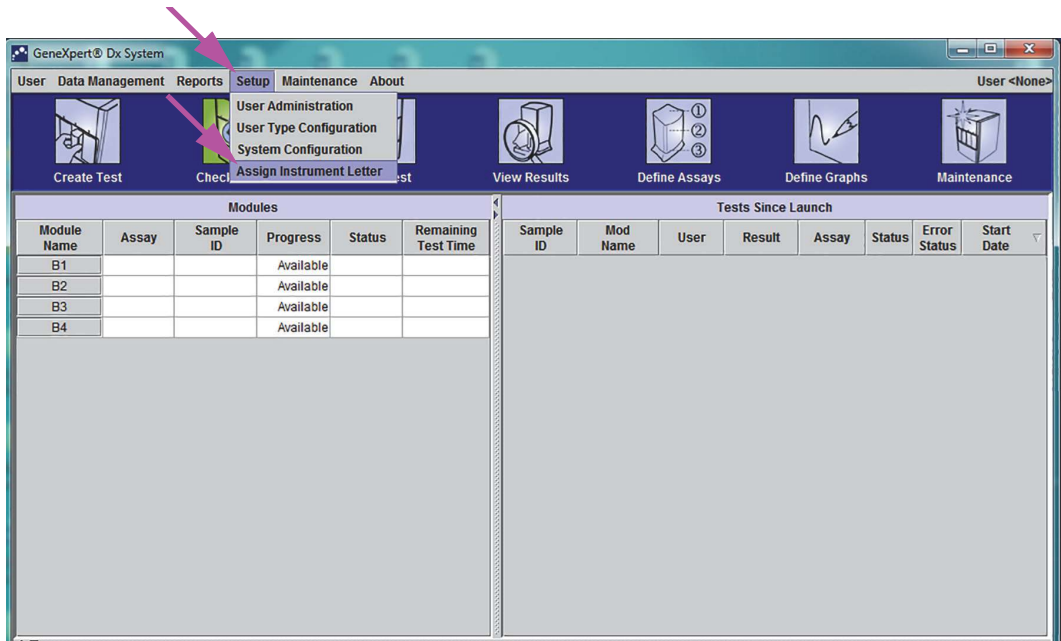

Figure 2-56. GeneXpert Dx System Window, showing the Setup Drop-Down Menu

- To change the assignment letter, click to select the instrument to change and then click **Change Letter** in the Assign Instrument Letter dialog box (see Figure 2-57).

The Change Letter dialog box appears, as shown in Figure 2-58. Select the letter to be assigned to the module(s) by using the up and down arrows of the Change Letter dialog box.

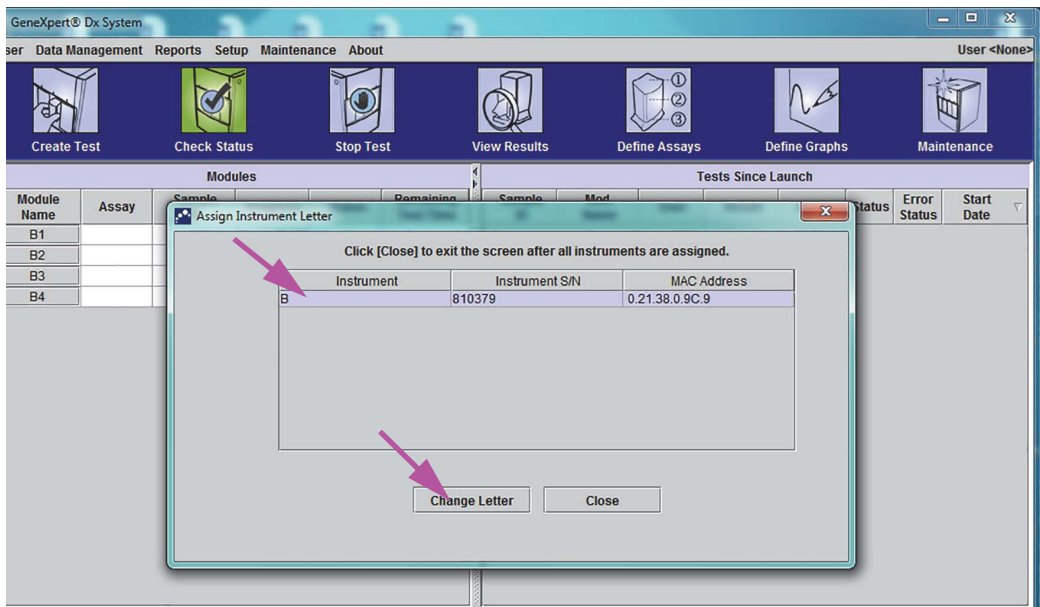

Figure 2-57. GeneXpert Dx System Window with Assign Instrument Letter Dialog Box Overlay

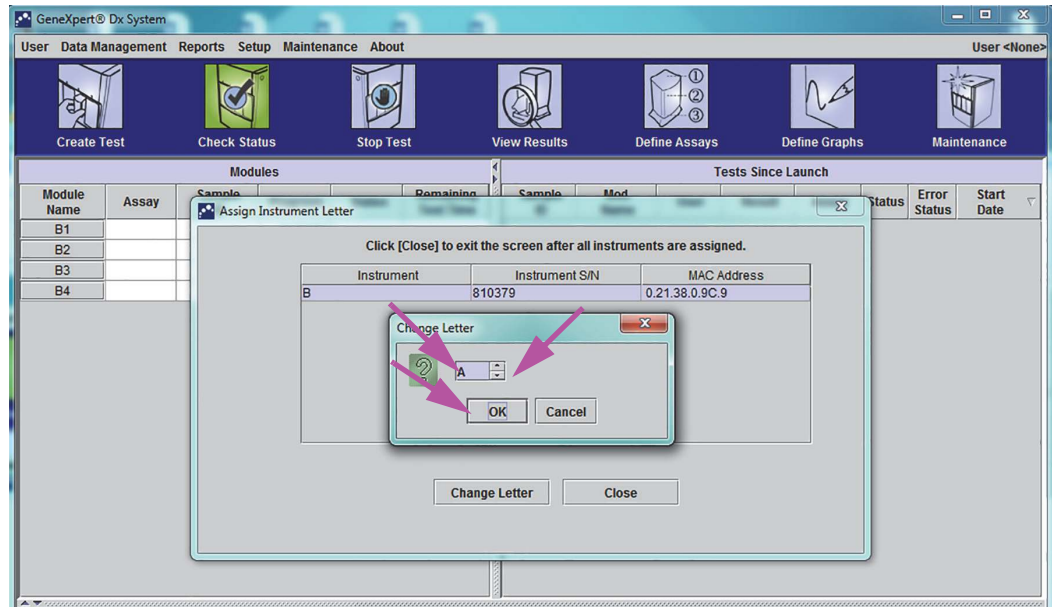

Figure 2-58. GeneXpert Dx System Window with Change Letter Dialog Box Overlay

6. After changing the assignment letter, click **OK** (see Figure 2-58).
7. Click **Close** to close the Assign Instrument Letter dialog box (see Figure 2-59). The Assign Instrument Letter dialog box will indicate the new instrument letter assignment for the modules.

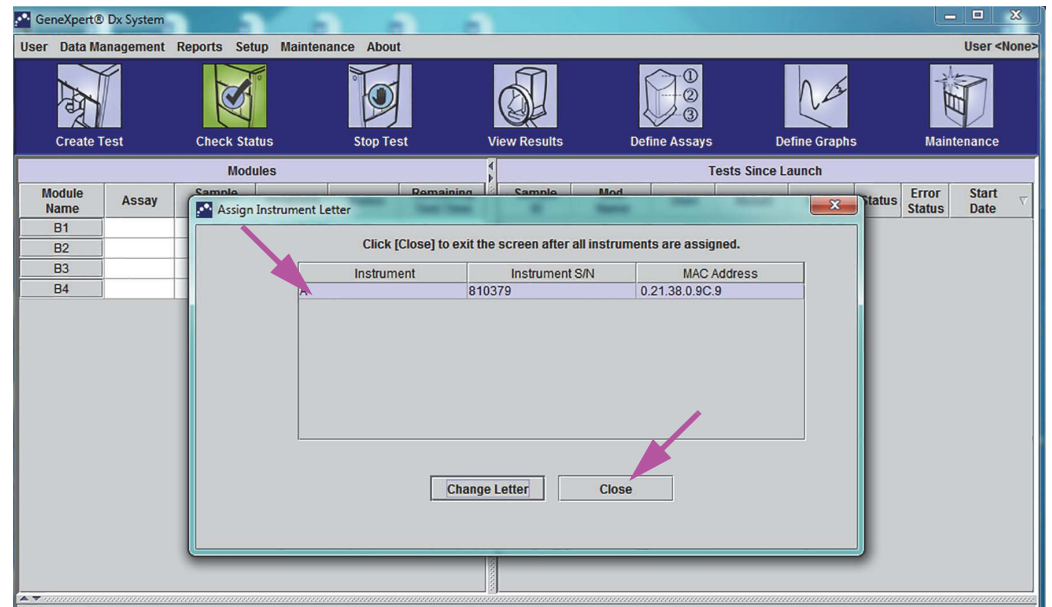

Figure 2-59. GeneXpert Dx System Window with Assign Instrument Letter Dialog Box Overlay

8. Click **OK** to close the Assign Instrument Letter dialog box (see Figure 2-60). The Module Name is updated with the new Instrument Letters.

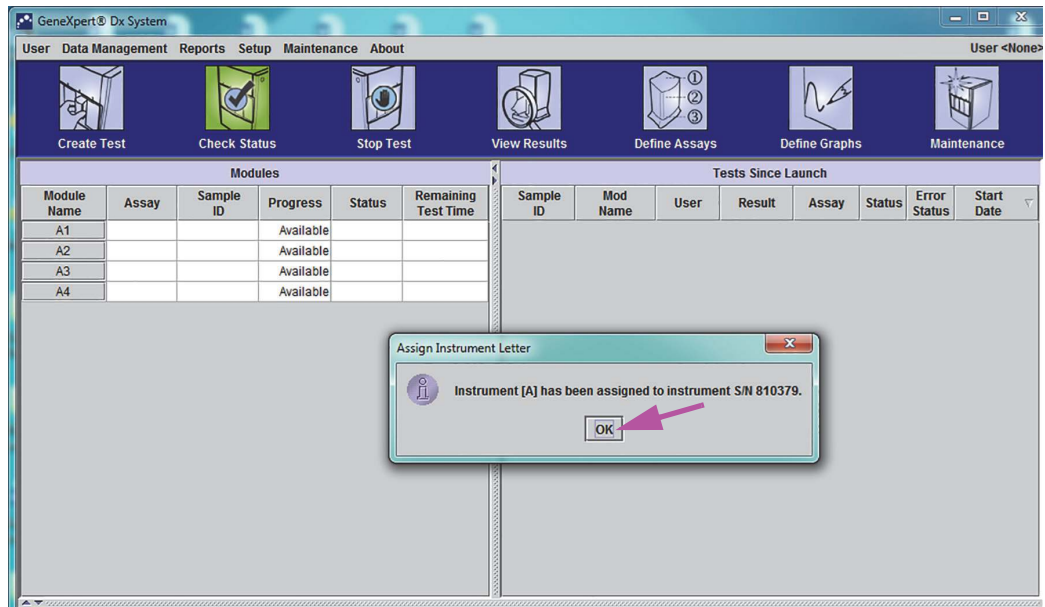

Figure 2-60. GeneXpert Dx System Window with Updated Instrument Letter Assignments

The GeneXpert Dx system window will be displayed, showing the updated letter assignments (see [Figure 2-61](#)).

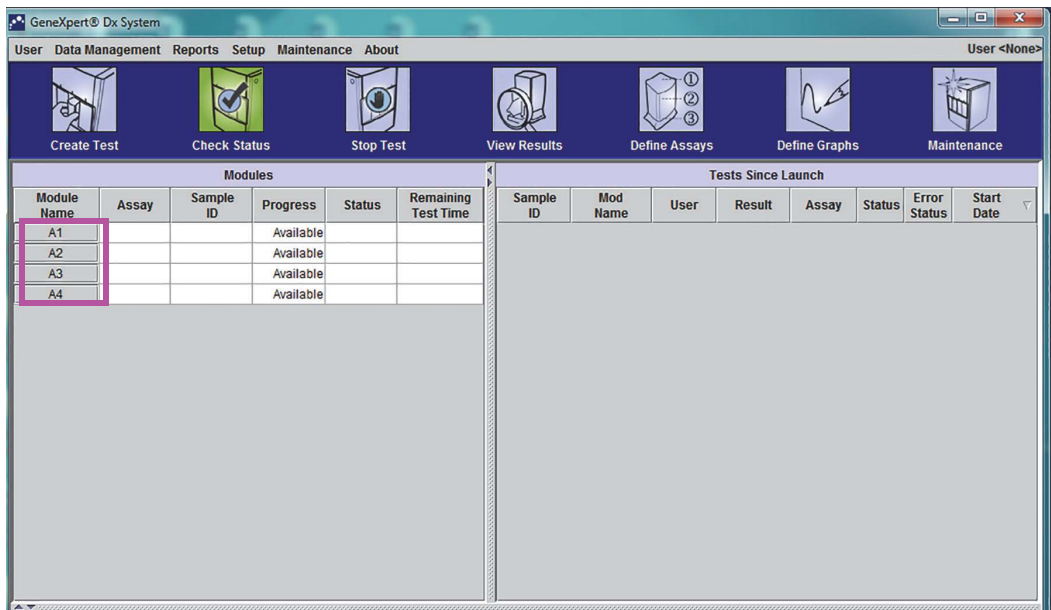

Figure 2-61. GeneXpert Dx System Window at System Restart

Configure the software and additional computer components. For details, see [Section 2.13, Defining Users and Permissions](#).

2.12.2 To Assign Instrument Letters (GX-XVI Instruments)

Note

Only a GeneXpert Dx system administrator or users with the appropriate privileges can assign instrument letters.

The GeneXpert Dx software automatically assigns a letter (A, B, C or D) to identify each quadrant of the GeneXpert GX-XVI instrument connected to the computer. Figure 2-62 shows how each quadrant of the GX-XVI is seen by the system.

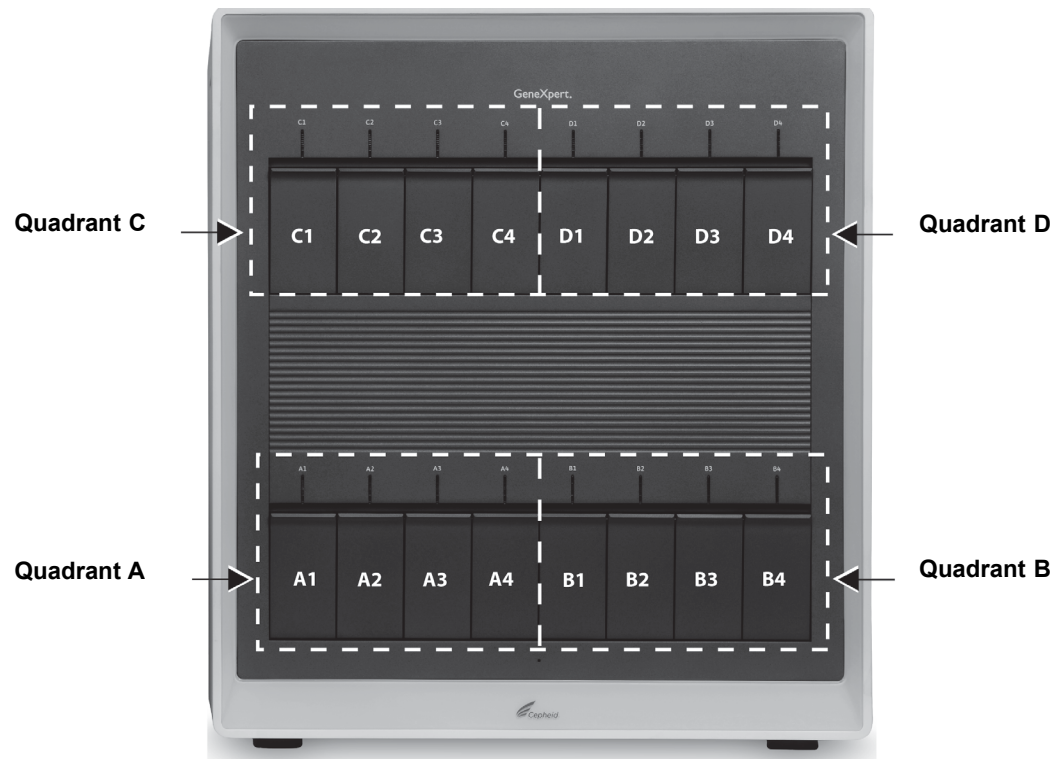

Figure 2-62. Quadrant Assigned Letters (GX-XVI Shown)

In addition to assigning instrument letters, the software also assigns a number (1, 2, 3 or 4) to each module that is installed. For example, C1 is the first or left-most module of the C instrument (quadrant C). The instrument and module identification appears in the **Module Name** column in all the software windows.

The first time the software is started after installation, the software will automatically assign instrument letters (shown in the Modules column on the left of the GeneXpert Dx System window). See Figure 2-63.

Note

In the screen examples shown in this section, the GeneXpert GX-XVI only has eight modules installed and active (not the full complement of 16 modules).

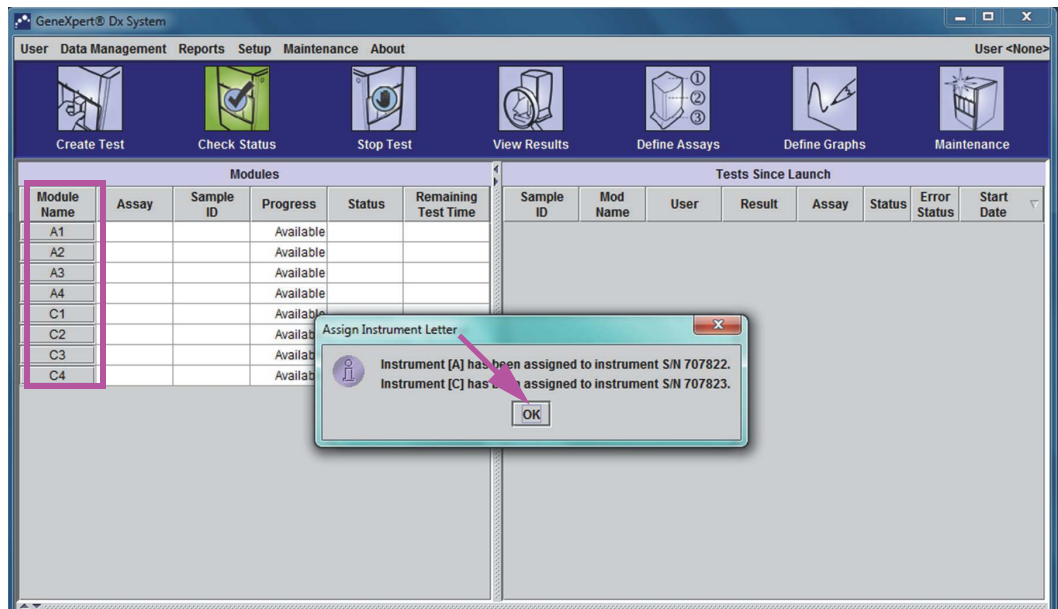

Figure 2-63. GeneXpert Dx System Window with Assign Instrument Letter Dialog Box Overlay

1. In the Assign Instrument Dialog box, click **OK** to acknowledge the assignment of instrument letters. When the Assign Instrument Dialog box closes, the Database Management dialog box appears (see [Figure 2-64](#)).

Note

You will have an opportunity to change these instrument letter assignments later in this section, if needed.

Note

The examples in this section shows how to change instrument letter “C” to “B.”

2. In the Database management dialog box, click **NO** to proceed. The GeneXpert Dx System screen appears (see [Figure 2-65](#)).

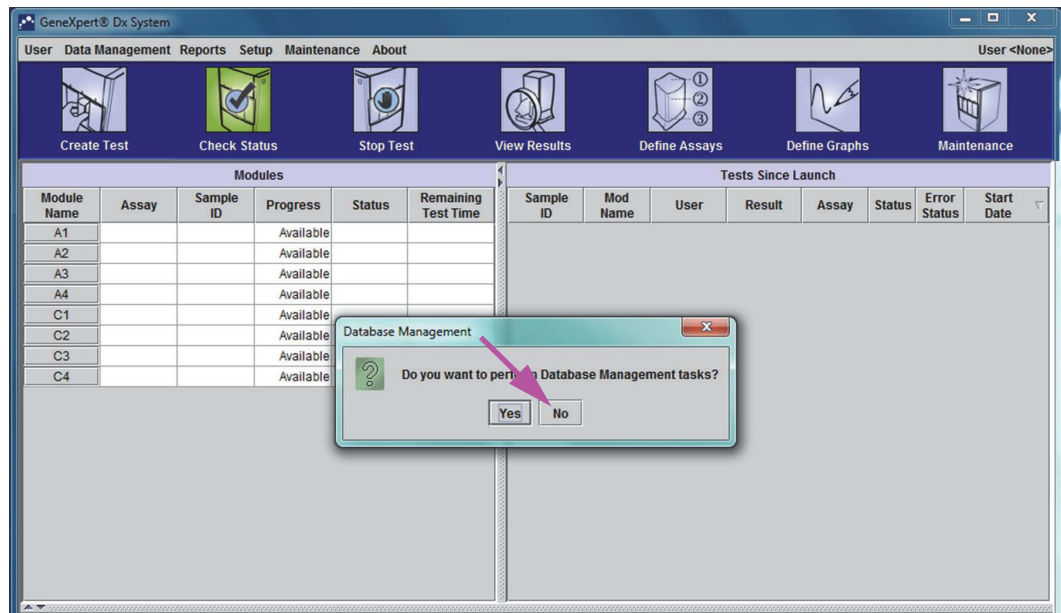

Figure 2-64. GeneXpert Dx System Window with Database Management Dialog Box Overlay

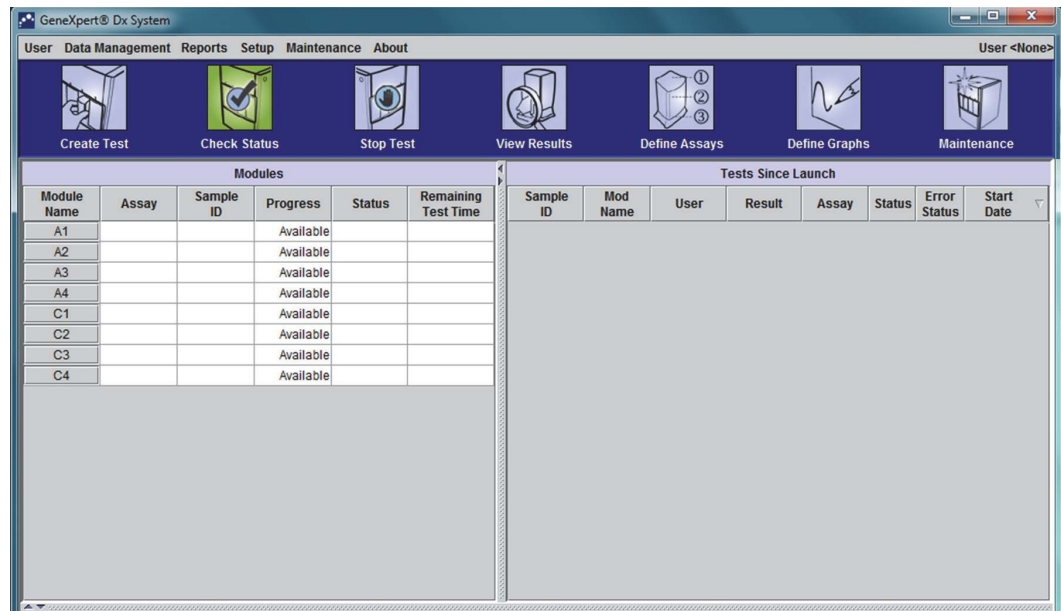

Figure 2-65. GeneXpert Dx System Window

- To ensure that letter assignments match the GeneXpert GX-XVI instrument, click **Setup** in the menu bar, on the GeneXpert Dx System window (see Figure 2-66), and then select **Assign Instrument Letter** from the drop-down menu. The Assign Instrument Letter dialog box is displayed (see Figure 2-67). At the same time, the green LED indicators of four modules that comprise the selected quadrant will flash.

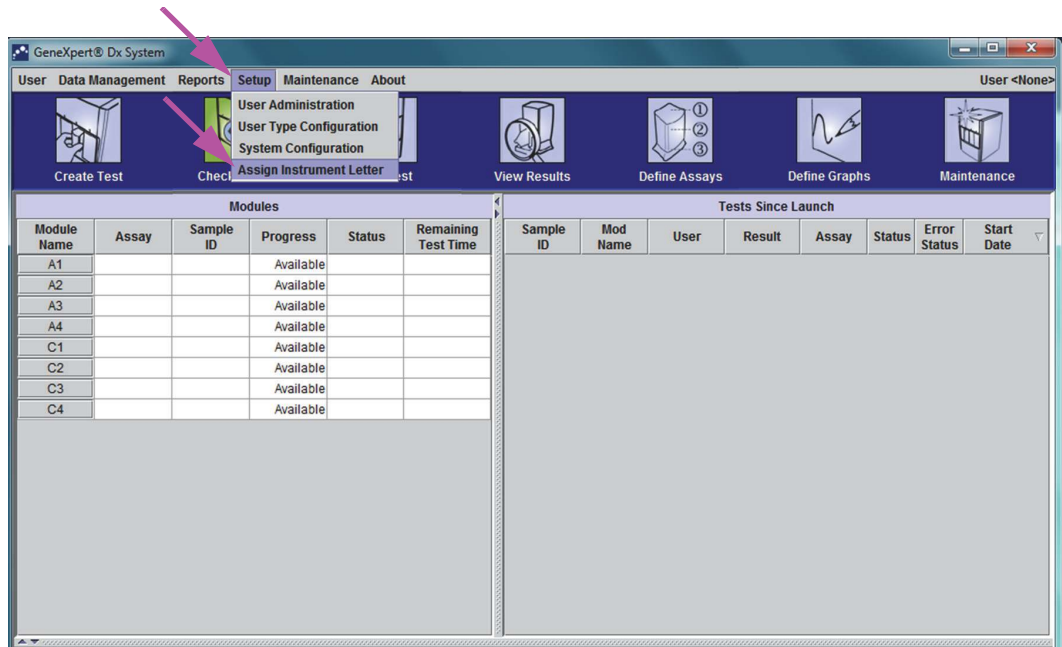

Figure 2-66. GeneXpert Dx System Window showing Setup Drop-Down Menu

4. To change the assignment letter, click to select the instrument to change and then click **Change Letter** in the Assign Instrument Letter dialog box (see Figure 2-67).
The Change Letter dialog box appears, as shown in Figure 2-68. Select the letter to be assigned to the module(s) by using the up and down arrows of the Change Letter dialog box. Select the letter that corresponds to the quadrant defined by the four flashing modules. For example, if the lower-right set of modules (Quadrant B in Figure 2-62) is flashing, select **B** as the new letter.

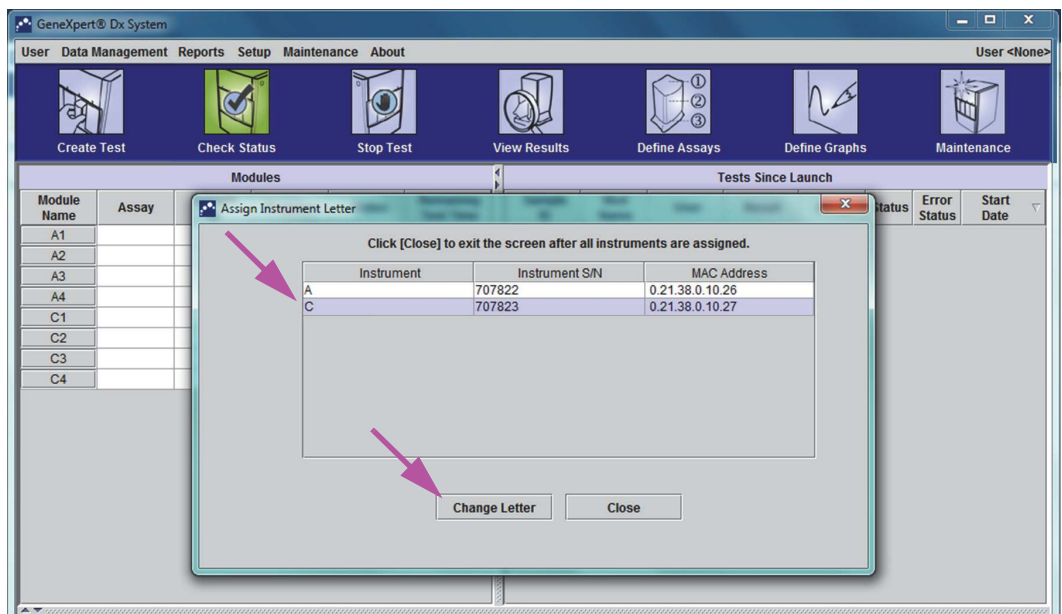

Figure 2-67. GeneXpert Dx System Window with Assign Instrument Letter Dialog Box Overlay

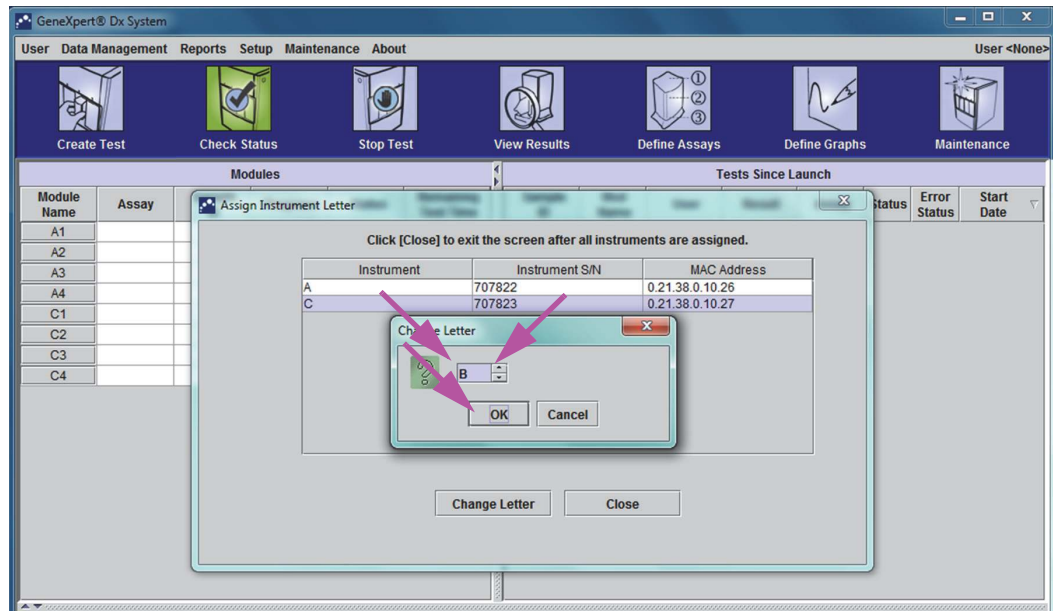

Figure 2-68. GeneXpert Dx System Window with Change Letter Dialog Box Overlay

5. After changing the assignment letter, click **OK**. See [Figure 2-68](#).
6. Click **Close** to close the Assign Instrument Letter dialog box (see [Figure 2-67](#)).
7. Continue to assign instrument letters until all four quadrants are correctly assigned to the letters **A**, **B**, **C** and **D**. The new assignment letter will be displayed in the table in the Assign Instrument Letter dialog box.
8. Click **Close**.

The GeneXpert Dx system window will be displayed, showing the updated letter assignments (see [Figure 2-69](#)).

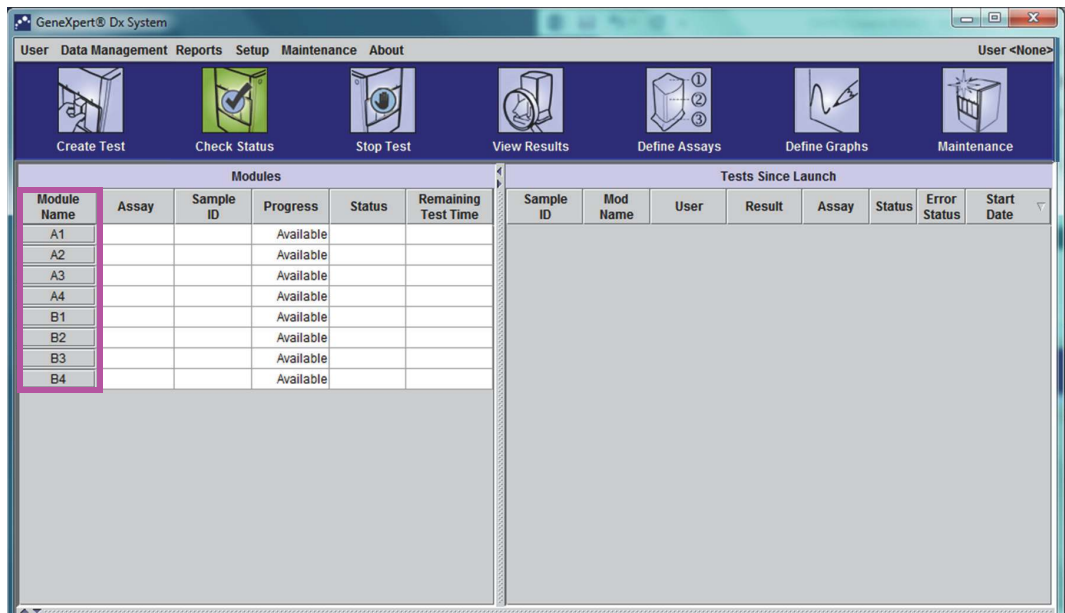

Figure 2-69. GeneXpert Dx System Window showing New Module Letter Assignments

Configure the software and additional computer components, if needed. For details, see [Section 2.13, Defining Users and Permissions](#).

2.13 Defining Users and Permissions

Note

Only a GeneXpert Dx system administrator or users with the appropriate privileges can define users and permissions.

Before starting to use the GeneXpert Dx system software, the GeneXpert Dx system administrator and other system users must be defined. All the administrator functions are accessible from the Setup menu in the GeneXpert Dx System window. See [Figure 2-54](#).

2.13.1 User Types

The GeneXpert Dx system allows the Administrator to set up task permissions for different user types, such as Basic and Detail. As the system administrator, you can use this feature to limit access to the software functions based on your organization's policies. For example, you might want to set up the policy presented in [Table 2-1](#).

Table 2-1. Example User Permission Policy for In Vitro Diagnostic Use

User Type	Run Test	View Results	Perform Maintenance	Perform Administrative and System Functions
Basic	Yes	Summary Only	No	No
Detail	Yes	All Details	Limited	No
Administrator*	Yes	All Details	All	Yes

*The Administrator user type has permissions to perform all the tasks, and the permissions of the Administrator cannot be changed.

2.13.2 Specifying User Permissions

To specify permitted tasks for each user type, in the GeneXpert Dx System window, on the Setup menu, click **User Type Configuration**. The User Type Configuration dialog box appears and displays a permissions table.

- To allow a user type to perform certain tasks, select the task check boxes in the user type column. See [Table 2-2](#) for a complete list and description of the tasks.
- To remove a permission, clear the task check box in the user type column.
- To return all three user types to the default permission selections, click **Reset to Default**.

After specifying the permissions, click **OK** to save the changes and close the dialog box.

[Table 2-2](#) lists the tasks as they appear in the User Type Configuration dialog box. The table provides a description of each task.

Table 2-2. User Task Descriptions

Task	Description	Default User Settings		
		Basic	Detail	Admin.
Create/Start Test	Allows an in vitro diagnostic test to be created and started (see Section 5.6 and Section 5.8).	X	X	X
Stop One Test or All Tests	Allows stopping one or more tests in progress (see Section 5.10).	X	X	X
View Detailed Research Assay Test Result and Report	Allows the user to view detailed research assay test results and reports (not used for IVD diagnostic tests).		X	X
View Detailed Template Assay Test Result and Report	Allows the user to view detailed template assay test results and reports (not used for IVD diagnostic tests).		X	X
View Detailed Reference Assay Test Result and Report	Allows the user to view detailed reference assay test results and reports (not used for IVD diagnostic tests).		X	X

Table 2-2. User Task Descriptions (Continued)

Task	Description	Default User Settings		
		Basic	Detail	Admin.
Edit Test Details	Allows editing the in vitro diagnostic test information (see Section 5.12).	X	X	X
Delete Assay and Lot Specific Parameters	Allows the deletion of an assay definition or lot specific parameter (see Section 2.16).		X	X
Manage Assay Definition	Allows the user to import assay definition (.gxa/.nxa) and lot specific parameter (.gxr/.nxr) files (see Section 2.16).	X	X	X
Edit Graphs	Allows the user to edit graphs for a research assay (not used for IVD diagnostic tests).			X
Archive Test	Allows the archiving and deletion of (optional) test data (see Section 5.16.1).	X	X	X
Purge Test	Allows the purging of a test from the database (see Section 5.16.1).		X	X
Retrieve Test	Allows test data to be retrieved from the test archives (see Section 5.16.2).		X	X
Backup Database	Allows the backing up of the database (see Section 5.17.1).	X	X	X
Restore Database	Allows the restoration of the database (see Section 5.17.2).			X
Compact Database	Allows compacting of the database (see Section 5.17.3).			X
View Specimen and Patient Reports	Allows the display of an overview of the test results for the selected specimen in the database, and the display of test results for samples for one patient according to the Patient ID in the database.	X	X	X
View Control Trend and Assay Statistics Reports	Allows the creation and display of the external-control trend reports (see Section 6.4), and the display of a report showing the number of tests performed for each assay over a period of time with monthly breakdown values.		X	X
View System Log	Allows the creation and display of a report about recent self-tests and instrument errors.		X	X
Edit System Configuration	Allows modification of the system configuration information (see Section 2.14).			X
Assign Instrument Letter	Allows the changing of the instrument letter assignment (see Section 2.12).		X	X
View IQ Report	Allows the viewing of the installation qualification report (see Section 2.15).	X	X	X
View Module Reporter	Allows the display of the reporters available in a module.		X	X
Run Plunger Rod Maintenance	Allows the lowering of the plunger in the instrument for cleaning (see Section 9.4).	X	X	X
Run Self-Test	Allows performing an instrument module self-test (see Section 9.14).	X	X	X
Open Door	Allows unlocking and opening an instrument module door and updating cross-platform ICORE EEPROM format.			X
Exclude Modules from Test	Allows the user to exclude modules from being used for running a test if they are suspected to have a problem (see Section 9.15).	X	X	X

Table 2-2. User Task Descriptions (Continued)

Task	Description	Default User Settings		
		Basic	Detail	Admin.
View About Box	Allows the user to display the About window, view the software version number, copyright information and software license agreement.	X	X	X

2.13.3 Managing Users

The GeneXpert Dx system administrator can add users to the system and categorize them as different user types, edit the user profiles or remove users from the system.

2.13.3.1 Adding New Users

Important

The first user to be added must be the administrator. Having the administrator profile allows other users to be added and the system to be configured.

Note

Until the administrator profile has been defined, anyone using the software has full access to all of the tasks.

To add users:

1. In the GeneXpert Dx System window (see [Figure 2-56](#)), on the **Setup** menu, click **User Administration**. The User Administration dialog box appears. See [Figure 2-70](#).

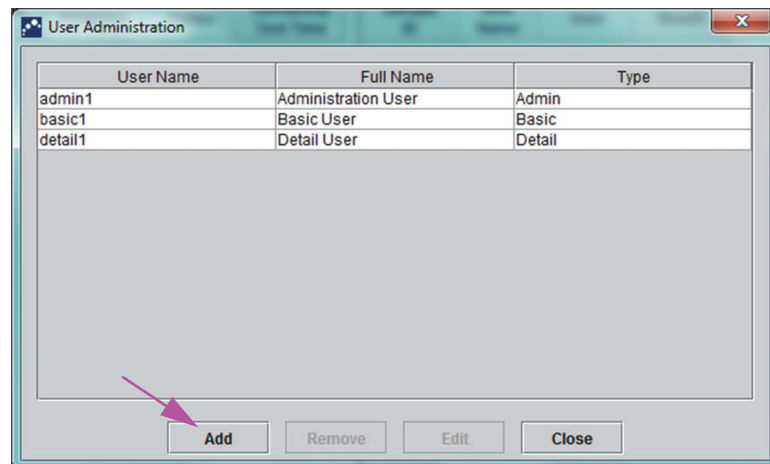

Figure 2-70. User Administration Dialog Box

2. Click **Add**. The Add User dialog box appears. See [Figure 2-71](#).
3. In the **User Name** box, type a unique user name containing 6 to 10 characters that can include spaces. For example, the first user to be added is the administrator, so enter **admin1** (or an equivalent user name).

4. (Optional) In the **Full Name** box, type the full or actual name of the user. For this example, the full name of the administrator will be **Administration User**. The full name can contain a maximum of 32 characters. Do not use special characters, such as the quotation marks (" "). If a name is not provided, the software will automatically insert the user name in this box. This name appears in the test reports.
5. In the **Password** and **Confirm Password** boxes, type the password for the user. The password must contain 6 to 10 characters.
6. In the **User Type** list, select the type you want, to categorize the user. See [Section 2.13.1, User Types](#).
7. When finished, click **OK** to save the changes and close the Add User dialog box and display the User Administration dialog box. The new user will appear in the User Administration dialog box.

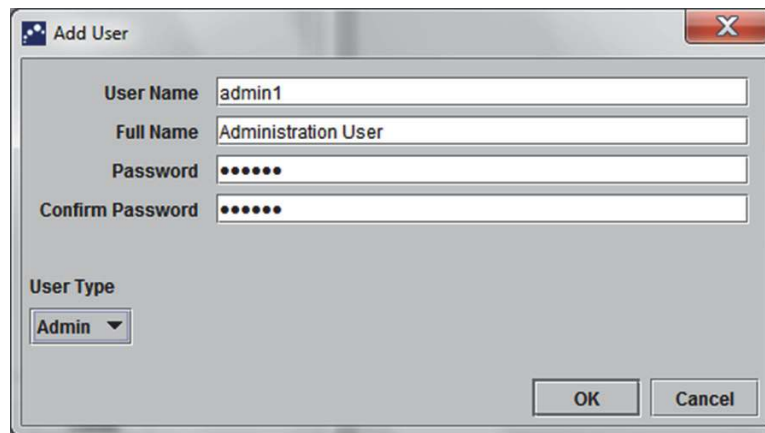

Figure 2-71. Add User Dialog Box

8. Repeat [Step 2](#) through [Step 7](#) until all users have been added to the system.
9. Click **Close** to close the User Administration dialog box.

2.13.3.2 Editing User Profiles

To change a user name or password, or to make other changes to a user profile:

1. In the GeneXpert Dx System window (see [Figure 2-56](#)), on the Setup menu, click **User Administration**. The User Administration dialog box appears. See [Figure 2-70](#).
2. In the User Administration dialog box, in the **User Name** column, select the user profile to be edited.
3. Click **Edit**. The Edit User dialog box appears. See [Figure 2-72](#).
4. Revise the information, as desired, and then click **OK** to save the changes and close the Edit User dialog box.
5. Click **Close** to close the User Administration dialog box.

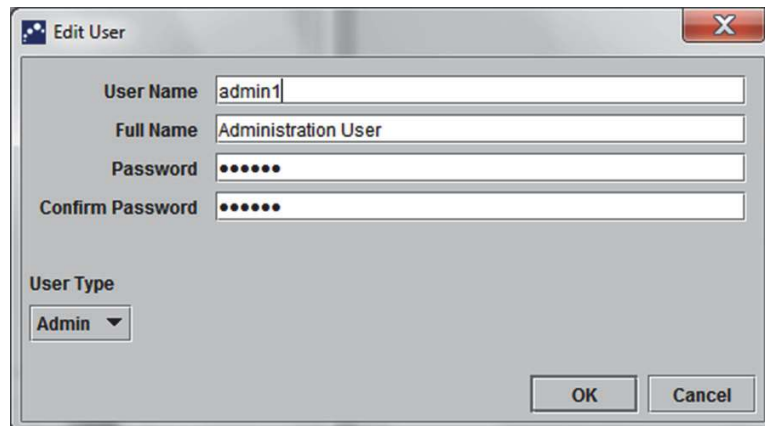

Figure 2-72. Edit User Dialog Box

2.13.3.3 Removing Users

Note When removing a user, the tests created by that user will remain in the database.

To remove a user:

1. In the GeneXpert Dx System window (see [Figure 2-56](#)), on the **Setup** menu, click **User Administration**. The User Administration dialog box appears. See [Figure 2-73](#).

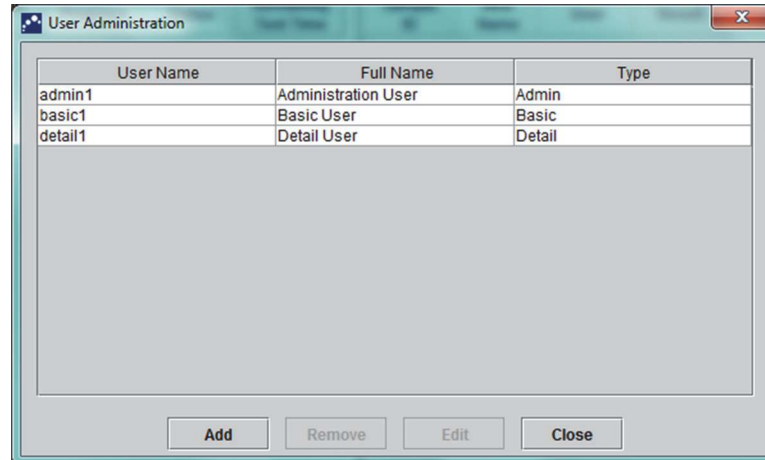

Figure 2-73. User Administration Dialog Box

2. Click to select the user to be removed. See [Figure 2-74](#).

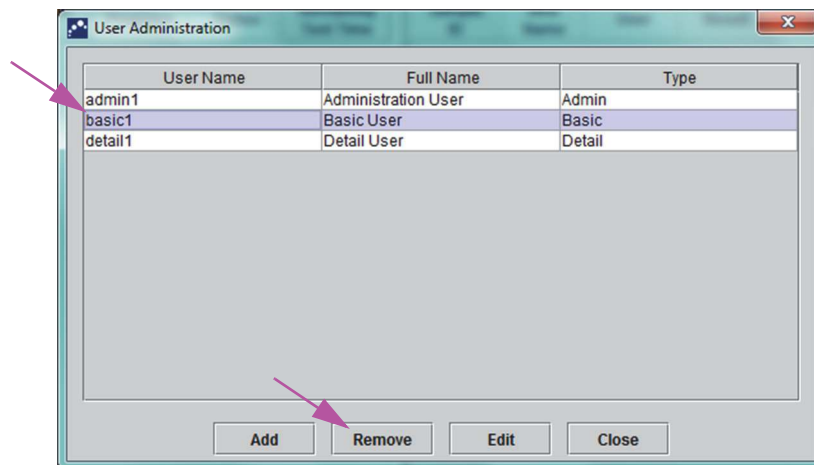

Figure 2-74. User Administration Dialog Box selecting User to be Removed

3. Click **Remove**. The user is removed. See [Figure 2-75](#).
4. To remove additional users, repeat [Step 2](#) and [Step 3](#). If you are done removing users, click **Close** (see [Figure 2-74](#)).

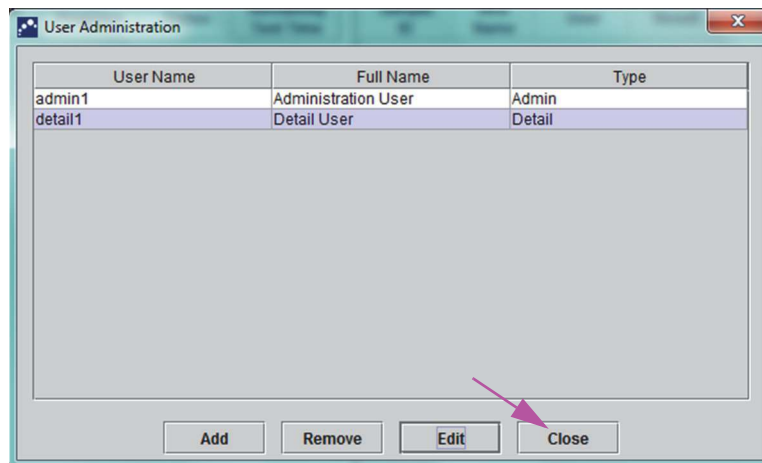

Figure 2-75. User Admin Dialog Box after User Removal

2.14 Configuring the System

Using the System Configuration function, the following can be specified:

- a name for the system (**General** tab)
- the date and time formats (**General** tab)
- options for creating a test (**General** tab)
- control of how the archive reminder is performed (**Archive Settings** tab)
- default folder paths for the exported test data, reports, and other information (**Folders** tab)
- LIS interface (**Host Communication Settings** tab)

2.14.1 General Tab

1. In the GeneXpert Dx System window (see [Figure 2-56](#)), click **Setup** on the menu bar, then click **System Configuration**. The System Configuration dialog box and the **General** tab appears. See [Figure 2-76](#).
2. Provide the requested information for the **General** tab as follows:
 - **System Name** box—Type a unique name for the system. The system name will be displayed in all of the reports.
 - **Date Format** list—Select the format to be used to display the month, day and year.
 - **Time Format** list—Select the 24-hour or the 12-hour format.

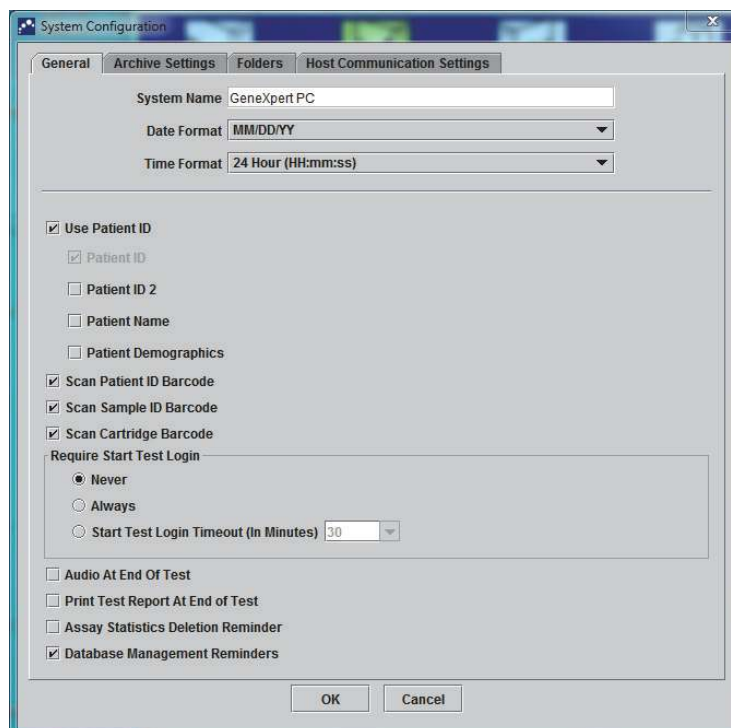

Figure 2-76. System Configuration Dialog Box (General Tab)

- **Use Patient ID**—If Patient ID is enabled, the **Scan Patient ID Barcode** can be selected and used. Patient ID is available in Create Test and View Results. Selecting **Use Patient ID** will enable the check boxes below it to become active:
 - **Patient ID**—If **Use Patient ID** is enabled, **Patient ID** will also be enabled and cannot be unchecked. The **Patient ID** field can contain up to 32 alphanumeric characters excluding illegal filename characters.
 - **Patient ID 2**—If **Use Patient ID** is enabled, **Patient ID 2** may be enabled to allow entry of additional patient identification. This field is optional and does not require an entry if there is no additional patient ID. Select the check box to enable **Patient ID 2**. The **Patient ID 2** field can contain up to 32 alphanumeric characters excluding illegal filename characters.
 - **Patient Name**—If **Use Patient ID** is enabled, **Patient Name** may be enabled to allow entry of the patient’s name. This field is optional and does not require an entry if you do not want to enter a patient name. Select the check box to enable **Patient Name**.
The **Patient Name Last Name** field can contain up to 194 alphanumeric characters excluding illegal filename characters. The **Patient Name First Name** field can contain up to 30 alphanumeric characters excluding illegal filename characters.

Important

The following symbols cannot be used for Sample ID, Patient ID, Patient ID2, First Name, Last Name, Other Sample Type, or Notes: | @ ^ ~ \ & / : * ? " < > ' \$ % ! ; () -

Note

For screenshots and reports shown later in this manual, the **Patient ID** field will be shown as enabled.

- **Patient Demographics**—Select to enable the visibility of the Patient Demographics. Demographics data is associated with the corresponding patient's test result.
Upon test creation, patient demographic information (Patient Name, Date of Birth, Ethnicity, Gender and Postal Code) will be encrypted and saved in the GeneXpert Dx database and will not be shown in the software.

Note

The checkbox for **Patient Demographics** will be unchecked by default in System Configuration. Only the system administrator can check or uncheck the **Patient Demographics** option. Demographics data can only be used in future connectivity solutions.

- **Scan Patient ID Barcode**—Select to enable the software to prompt for the Patient ID barcode to be scanned. Clear the check box to disable the prompt for the Patient ID barcode.
- **Scan Sample ID Barcode**—Select to enable the software to prompt for the Sample ID barcode to be scanned. Clear the check box to disable the prompt for the Sample ID barcode.
- **Scan Cartridge Barcode**—Select to enable the software to automatically prompt the cartridge barcode to be scanned (recommended). Clear the check box to disable the prompt for the cartridge barcode.
- **Require Start Test Login**—This option allows the system administrator to configure if Start Test Login is required for traceability of the person who started a test and the period for the Start Test Login.
The options provided to the administrator are:
 - **Never**—Start Test Login screen is never displayed when the **Start Test** button is pressed in the Create Test screen.
 - **Always**—This option is the default. Start Test Login screen is always displayed if there is a custom-defined user and when the **Start Test** button is pressed in the Create Test screen.
 - **Start Test Login Timeout (In Minutes)**—If this option is selected and if there is a custom-defined user, the system monitors the time lag since the most recent user login or Start Test Login. After this amount of time elapses and the user presses the **Start Test** button in Create Test window, then the Start Test Login dialog box appears.
The timeout counter will be reset when any user logs in. The system administrator can select from 1 to 60 minutes using the drop-down list or enter a value in the same range. The default is 30 minutes.

3. Select or clear the following check boxes:
 - **Audio At End of Test**—If the user turns on the audio option, a short tone will be provided at the end of the test. This feature utilizes the Windows default beep sound and settings.
 - **Print Test Report At End of Test**—This option allows a test report to be automatically printed to the Windows system default printer in the default format.

Note

If the printer is out of paper, the test report is still present even though the report has not printed. Depending on the printer, when paper is loaded and the paper tray is closed, the waiting reports will automatically start printing, and it may not be necessary to manually print the test report.

- **Assay Statistics Deletion Reminder**—The user can enable or disable the Assay Statistics Deletion Reminder. The default is enabled.
- **Database Management Reminders**—The user can enable or disable the Database Management Reminders. The default is enabled.

If Database Management Reminders are enabled, the user is prompted on startup and shutdown whether to perform database management tasks. The prompt appears only if the user has privileges to perform these tasks. If the user does not have any of these privileges or if Database Management Reminders are disabled, the prompt will be skipped.

4. Click **OK** to save the changes and close the window.

2.14.2 Archive Settings Tab

This tab provides the settings that control how the archive reminder is performed. The time interval can be selected or when to be reminded to archive files: **Never**, **Weekly**, or **Monthly**.

1. In the GeneXpert Dx System window (see [Figure 2-56](#)), click **Setup** on the menu bar, then click **System Configuration**.
2. Select the **Archive Settings** tab. The **Archive Settings** tab information appears. See [Figure 2-77](#).

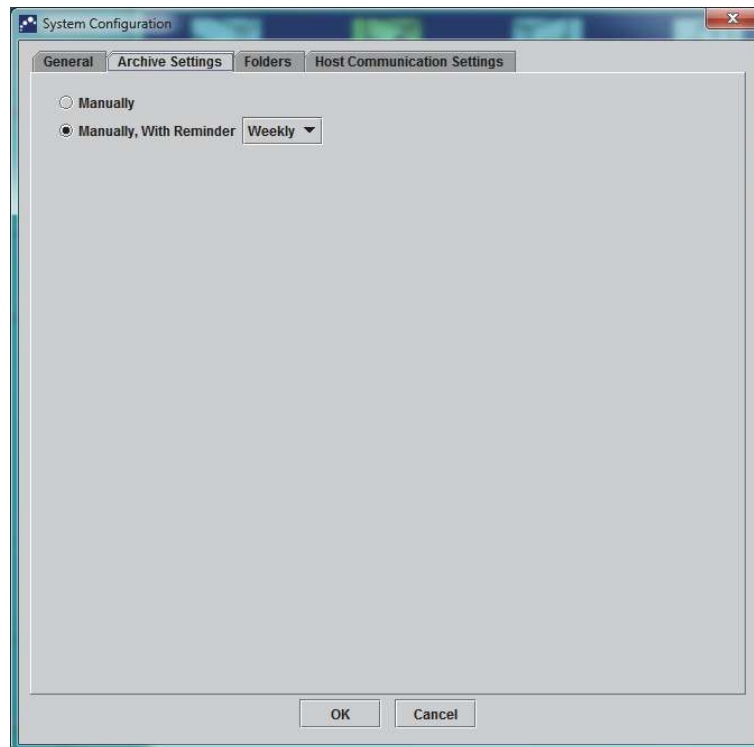

Figure 2-77. System Configuration Dialog Box (Archive Settings Tab)

3. Select the desired options:

- **Manually**—If this option is selected, archiving has to be performed manually by the user, at the user’s convenience, and will follow the manual archive process.
Manually, With Reminder—If this option is selected, a reminder will be displayed if the user has Archive Test privilege. This reminder is not displayed for the users who do not have Archive Test privilege.

The user can choose to receive reminders weekly or monthly. The default will be weekly.

The system will attempt to remind the user to perform an overdue archive if the last archive was performed in the last week or the last month (depending on the reminder period selected). The last week or the last month is defined as being the day prior to the first day of the current week/month. The first day of a week is considered to be Monday. The first day of a month is the first of each month. In such an event, the reminder is displayed to the user when:

- GeneXpert Dx application starts
- GeneXpert Dx application normally terminates
- user logs in (excluding start test login)

If the user accepts the archive reminder prompt, the Archive Test dialog will be shown immediately.

If the user dismisses the reminder prompt, the software will proceed normally, and the user will be reminded the next time the reminder criteria are met.

4. Click **OK** to save the changes and close the window.

2.14.3 Folders Tab

1. In the GeneXpert Dx System window (see [Figure 2-56](#)), click **Setup** on the menu bar, then click **System Configuration**.
2. Click the **Folders** tab. The **Folders** tab appears. See [Figure 2-78](#).

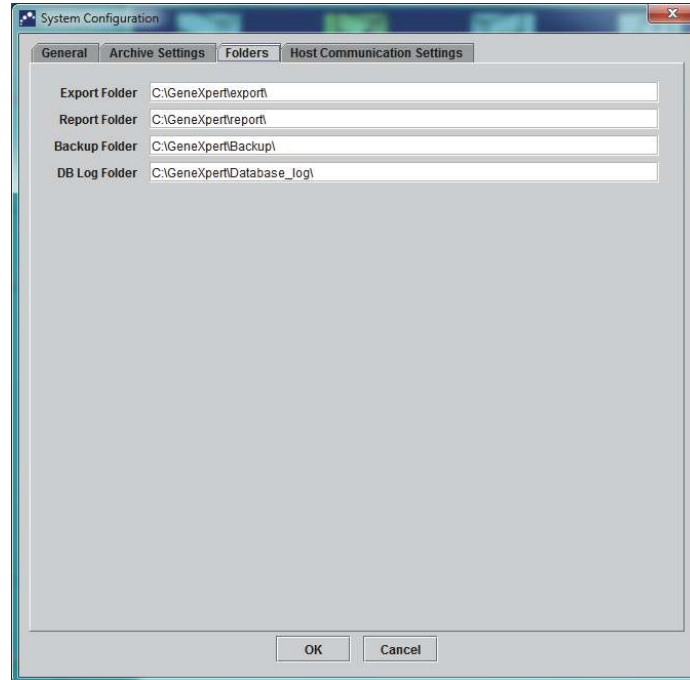

Figure 2-78. System Configuration Dialog Box (Folders Tab)

3. Provide the requested information for the **Folders** tab as follows:
 - **Export Folder** box—Type the path to the folder in which all of the exported test data will reside. Alternatively, the default path supplied can be used.
 - **Report Folder** box—Type the path to the folder in which all of the reports will reside. Alternatively, the default path supplied can be used.
 - **Backup Folder** box—Type the path to the folder in which the backup database will reside. Alternatively, the default path supplied can be used.
 - **DB Log Folder** box—Type the path to the folder in which the database log files will reside. Alternatively, the default path supplied can be used.

Caution



The default locations for each of the folders is located on the computer hard drive. To guard against loss of data, the files in the export folder should be periodically copied to a different computer or server. If the GeneXpert Dx system is connected to a network, it is possible to archive files directly to a server.

4. Click **OK** to save the changes and close the window.

2.14.4 Host Communication Settings Tab

The **Host Communication Settings** tab is used to configure the system software when a GeneXpert Dx is connected to a Laboratory Information System (LIS) host computer or Cepheid Link.

Note No configuration of this tab is required if an LIS system is not being used with the system.

Note To configure the host communication settings for an LIS, see [Section 2.14.4.1, Configuring Host Communications for an LIS](#). To configure the host communication settings for Cepheid Link, see [Section 2.14.4.2, Configuring Host Communications for Cepheid Link](#).

2.14.4.1 Configuring Host Communications for an LIS

1. In the GeneXpert Dx System window (see [Figure 2-54](#)), click **Setup** on the menu bar, then click **System Configuration** (see [Figure 2-56](#)).
2. Click the **Host Communication Settings** tab. The **Host Communication Settings** tab appears. See [Figure 2-79](#).

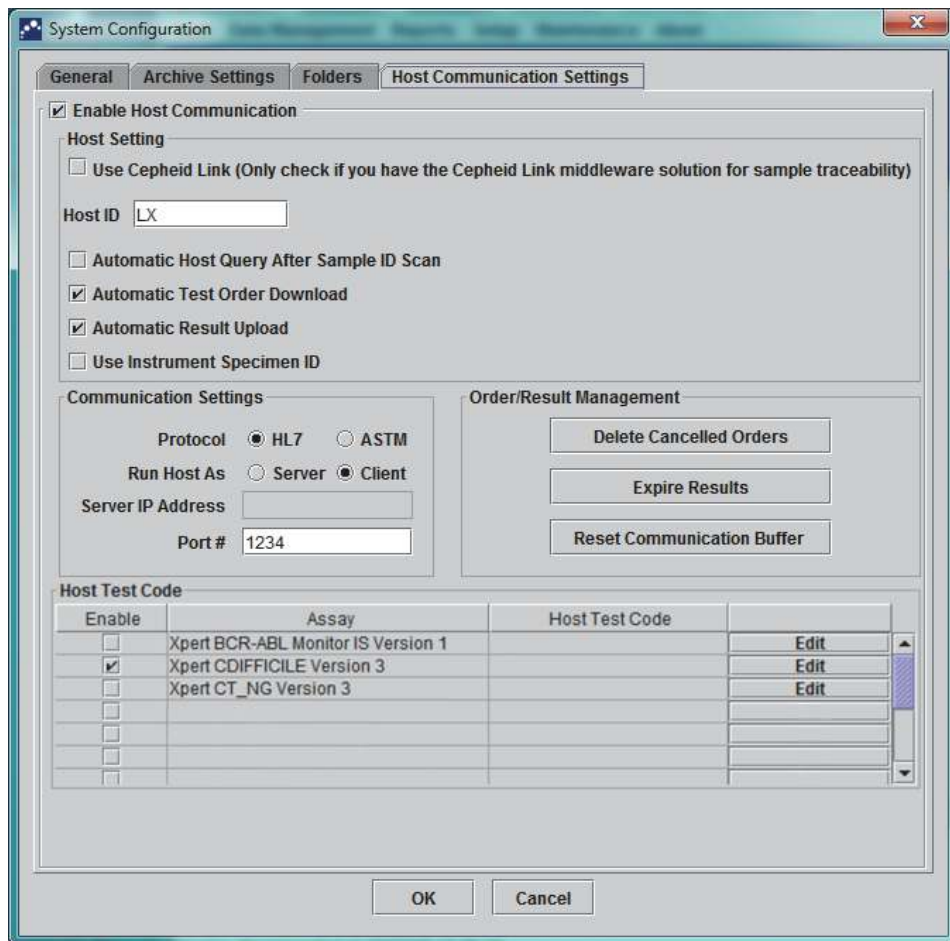

Figure 2-79. System Configuration Dialog Box (Host Communication Settings Tab)

Note

If the LIS is being enabled on a new system, there will be no assays shown.

Caution



Within the hospital or laboratory network, each GeneXpert Dx system should have a unique system name, which is used for host communication. The LIS host administrator should control the process for defining system names.

Important

Do not check the Use Cepheid Link checkbox when configuring the host communication settings for a hospital LIS system.

3. Provide the settings to configure the communication between the GeneXpert Dx software and a Laboratory Information System (LIS):
 - **Enable Host Communication**—Select to enable the GeneXpert Dx software connected to a host. Clear to disable the host communication.
 - **Host ID**— Type in a unique host name to identify an LIS or Data Management System (DMS) that is connected to this GeneXpert Dx system. The maximum number of characters is 20.
 - **Automatic Host Query After Sample ID Scan**—Select to enable the GeneXpert Dx system to query for test orders associated with the scanned or entered Sample ID.
 - **Automatic Test Order Download**—Select to enable the GeneXpert Dx system to periodically query all test orders from the host.

Caution



If the Host is connected to multiple GeneXpert Systems, you may want to:

- **Use Automatic Host Query After Sample ID Scan instead of Automatic Test Order Download to minimize duplicate orders to multiple GeneXpert systems.**
- **The host should download order to a specific GeneXpert System.**
- **If orders are sent to multiple GeneXpert systems, the host should cancel pending orders when completed result is received.**

- **Automatic Result Upload**—As soon as the test is completed, the results are uploaded.
- **Use Instrument Specimen ID**—Select to enable the GeneXpert Dx system to generate a unique specimen ID, which is returned to the host. The Instrument Specimen ID is a unique ID for this sample. It should be stored in the host and used for future communication for this sample. This option is applicable if the facility does not provide unique sample identification. If the facility provides unique sample identification, this setting should be disabled.
- **Communication Settings** box—Select or clear the following check boxes:
 - **Protocol**—Select HL7-compatible or ASTM-compatible protocol.
 - **Run Host As**—For socket connection between the two systems. Select to run the host as a server or a client.

- **Server IP Address**—If **Run Host As Server** option is selected, an IP address with 4-part value (N.N.N.N) should be entered. The value should match the IP address of the host server. N is between 0-255. If **Run Host As Client** option is selected, the IP address of the network card available for host connectivity is displayed.
- **Port #**—The port number should be between 1024 to 65535.

Caution



The network port that is dedicated for the GeneXpert instrument should not be used for the host connection. The second NIC available on each GeneXpert computer should be used to connect the GeneXpert Dx system to the host.

- **Order/Result Management**—Click the appropriate buttons:
 - **Delete Canceled Orders**—Click to delete canceled orders. This is useful to remove redundant orders during host communication testing.
 - **Expire Results**—Click to expire results pending upload for tests that should no longer upload to the host.

Caution



Do not use **Reset Communication Buffer** (discussed below) during normal operation; otherwise, you will have to re-download orders and re-upload results.

- **Reset Communication Buffer**—To clear the data between the GeneXpert Dx system and the host. This is useful to remove data during host communication testing.
- **Host Test Code** table—This look up table allows the host administrator to type in the test code that was entered into the host, so it can be translated into the GeneXpert Dx system for test order processing and result reporting.
 - **Enable**—Indicates if the assay has been set up for test order download and result reporting.
 - **Assay**—Assay name available for host connectivity.
 - **Host Test Code**—the test code which the host used for download of test order and upload of test result.

Important

You cannot edit the test code for old versions of an assay. If you update the test code, the update will only apply to the new version of the assay; therefore, you must change the test code before upgrading an assay.

Caution



Be careful to not use the same test code for tests from two different assays.

4. Click **Edit** button to enable the assay for host use and to define host test codes for that assay. See [Section 2.14.5](#) to configure the assay for order and result upload and to define host test codes.
5. Click **OK** to save the changes and close the window.

2.14.4.2 Configuring Host Communications for Cepheid Link

Important

Once the system has been configured for Cepheid Link, it cannot be used for non-LIS originated test orders or for running external controls without disabling Cepheid Link. Cepheid Link may be enabled again after running non-LIS originated test orders or external controls.

To enable and configure host communications for the GeneXpert Dx systems to Cepheid Link:

1. On the GeneXpert Dx system window (see [Figure 2-54](#)), select the **SETUP** button, then select the **SYSTEM CONFIGURATION** button (see [Figure 2-56](#)).
2. Select the **HOST COMMUNICATIONS SETTINGS** button (see [Figure 2-56](#)) to display the Host Communications Settings workspace. See [Figure 2-79](#).
3. To enable host communication, select the **Enable Host Communication** check box in the upper left corner of the workspace (see [Figure 2-80](#)). This allows other options to be selected on the Host Communication Settings screen.

Important

Within the hospital or laboratory network, each GeneXpert system should have a unique system name which is used in the communication. The host administrator should control the process for defining system names.

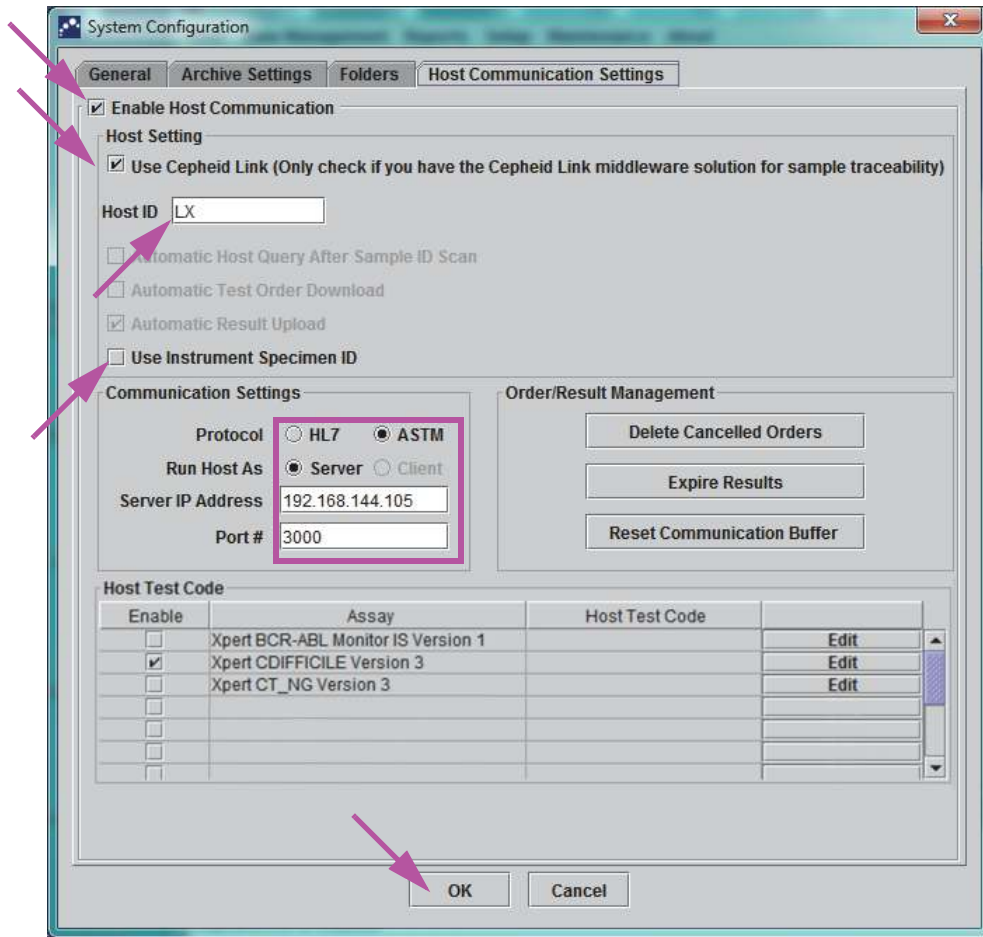

Figure 2-80. Host Communication Settings Workspace Configured for Cepheid Link

Important

All of the information to be entered into this workspace must be provided by the LIS network administrator. It is not provided by Cepheid.

4. Select the **Use Cepheid Link** checkbox to set up the host communication for Cepheid Link. After selecting the **Use Cepheid Link** checkbox, most of the configuration will be automatically set up. See [Figure 2-80](#).
5. In the General section of the Host Communication Settings workspace, enter the appropriate information and select the appropriate items to interface with the LIS network.
 - **Host ID** field—Type in a unique host name to identify this GeneXpert Dx system. The maximum number of characters is 20.
 - **Automatic Host Query After Sample ID Scan** check box—This check box is disabled when connecting to Cepheid Link,
 - **Automatic Test Order Download** check box—This check box is disabled when connecting to Cepheid Link,

- **Automatic Result Upload** check box—This check box is enabled when connecting to Cepheid Link,
 - **Use Instrument Specimen ID** check box—Select to enable the GeneXpert system to generate a unique specimen ID which is returned to the host. The Instrument Specimen ID is a unique ID for this sample. It should be stored in the host and used for future communication for this sample. This option is applicable if the facility does not provide unique sample identification.
If the facility provides unique sample identification, this setting should be disabled.
6. In the Protocol section of the Host Communication Settings workspace, select either **HL7-compatible** or **ASTM-compatible** protocol.
 7. In the Communication Settings section of the Host Communication Settings workspace, the host must be set to **Server** to communicate with Cepheid Link.
 - **Server IP Address** field—An IP address with 4-part value (**N.N.N.N**) should be entered. The value should match the IP address of the Cepheid Link server. **N** is between 0-255.
 - **Port #** field—The port number must be **3000** to communicate with the Cepheid Link server.
 8. After you have set up the host communications for the Cepheid Link server, select the **OK** button. See [Figure 2-80](#).
Select the **Cancel** button if you do not want to save the host communication settings.

Cepheid recommends to always confirm that LIS or HIS uploaded results match GeneXpert results after any changes to the GeneXpert or host system, including, but not limited to, changes to the following:

Note

- GeneXpert software version
 - GeneXpert assay definition files and version
 - GeneXpert host communication settings
 - Host middleware software or configuration changes
 - LIS software or configuration changes
-

2.14.5 Configuring Assay for Order and Result Upload

Caution

In order to perform the required assay, the same test code should be entered in the host, the GeneXpert Dx system and the Cepheid Link system, if applicable.

Caution

Do not change test orders until all test results have been uploaded.

2.14.5.1 Configuring a Single-Result Assay for Order and Result Upload

1. In the **Host Test Code** table section of the Host Communication Settings tab (see [Figure 5-89](#)), click the desired **Edit** button to change the setting. The Define Test Code dialog box appears. See [Figure 2-81](#).

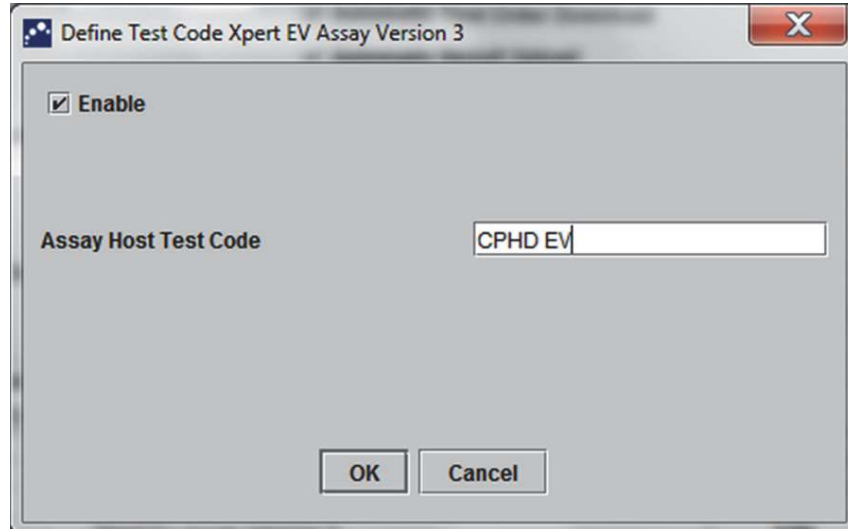

Figure 2-81. Define Test Code Dialog Box for a Single-Result Assay

2. Click the **Enable** checkbox to allow the host to download test orders and GeneXpert Dx system to upload results to the host using the defined assay test code.
3. In the **Assay Host Test Code** field of the Define Test Code dialog box, enter the same test code that was entered into the host system and the Cepheid Link system, if applicable. (the test code entered for the GeneXpert Dx system must be the same as the test code entered for host system and the Cepheid Link system). Enter in 1 to 15 characters.
4. Click **OK** to save the setting for this assay. The software will check for uniqueness of the test code before saving.

Note

Cepheid recommends that you use the same test code for the new version of the same assay. However, if you want to change the test code of the current assay, make the change before importing the next version.

2.14.5.2 Configuring a Multiple-Result Assay for Order and Result Upload

The multiple-result assay provides results for multiple organism and genes.

1. In the **Host Test Code** table section of the Host Communication Settings tab (see [Figure 2-79](#)), click the desired **Edit** button to change the setting. The Define Test Code dialog box appears. See [Figure 2-82](#).
2. Click the **Enable** checkbox to allow the host to download test orders and the GeneXpert Dx system to upload results to the host using the defined assay test code.

3. In the **Assay Host Test Code** field, enter the same test code that was entered into the host system and the Cepheid Link system, if applicable (the test code entered for the GeneXpert Dx system must be the same as the test code entered for host system and the Cepheid Link system). You can enter 1 to 15 characters.
4. The result names reported by the assay are listed in the **Result Name** field. See [Figure 2-82](#).
5. Type in the result test code in the **Result Test Code** field (see [Figure 2-82](#)) corresponding to each result name that can be reported by this assay.

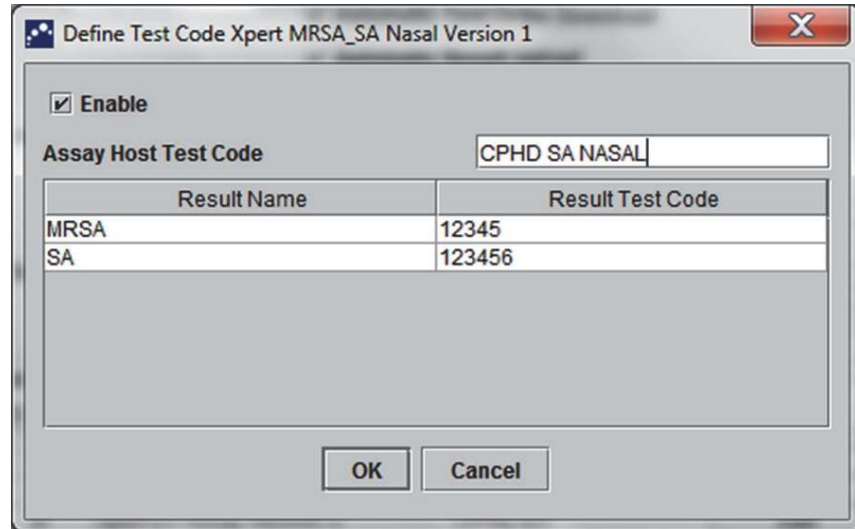

Figure 2-82. Define Test Code Dialog Box for a Multi-Result Assay

6. Click **OK** to save the changes and close the window.

2.15 Verifying Proper Installation and Setup

Note

This section describes tasks that all users with the appropriate permissions can perform. See [Section 2.13, Defining Users and Permissions](#).

After the instrument installation is complete (computer has been set up, the users and permissions have been defined and the system configured), verify that the system is properly installed and set up by running an Installation Qualification report to verify the installation. To do this:

1. In the GeneXpert Dx System window, on the **Reports** menu, click **Installation Qualification**. See [Figure 2-83](#).

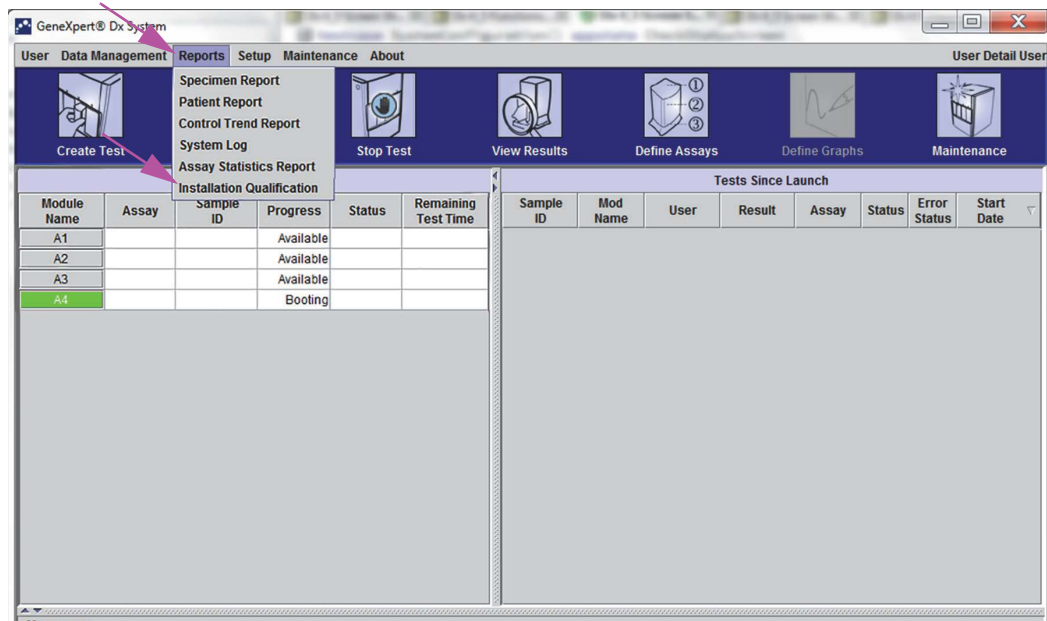

Figure 2-83. GeneXpert Dx System Window showing Reports Drop-Down Menu and Installation Qualification Selection

2. The Adobe® Reader window appears and displays the GeneXpert Dx System Installation Qualification Report. See [Figure 2-84](#).
3. Print the report. If the computer is not connected to a printer, save the file to a location where the report can be printed.
4. Review the following sections in the report:
 - **System Information**—Check that the Status column displays **Pass** in each row.
 - **Instrument Information**—For each instrument connected to the computer, the report shows the instrument serial number, the firmware installed, and the status of each operational module. If a **Reporter is out of calibration** or a **Not Available** message is shown, call Cepheid Technical Support. See the [Technical Assistance](#) section in the [Preface](#) for the contact information.
 - **Available Assays**—Check the assays in the list. If the **No Assays** message is shown, see the instructions provided with the *in vitro* diagnostics assay kit and [Section 2.16.2, Importing Assay Definitions](#) for instructions on how to import assay definition files.

If this report is run after system installation but before assays have been installed on the system, the **No Assays** message will be displayed. If the **No Assays** message is shown after importing the assay definition files, call Cepheid Technical Support. See the [Technical Assistance](#) section in the [Preface](#) for the contact information.
5. Sign the Installation Qualification Report and file a copy of the report for your records. See [Figure 2-85](#).

GeneXpert PC 03/20/20 13:04:15

GeneXpert® Dx System Installation Qualification Report

This report provides documented evidence of the installation of this GeneXpert® Dx System.

System Information

Software	Version	Status
GeneXpert® Dx System	6.2	Pass
Java Runtime Environment	1.8.0_151	Pass
SQL Database	Microsoft SQL Server 14.00.3015	Pass
Database	gx_db 4.0.1.0	Pass
Operating System	Windows 10 10.0	Pass
CIT Plug-In	1	Pass

Instrument Information

Instrument A

Instrument S/N	Gateway Firmware
803488	2.0.18

Module Name	Module S/N	Module Firmware	Internal Temp °C	Status
A1	628676	3.3.3	31.6	Pass
A2	638430	3.3.3	30.8	Pass
A3	638964	3.3.3	30.0	Pass
A4	641366	3.3.3	30.7	Fail*

Fail* = Ambient temperature too high, incorrect model number or hardware error has been detected. Please generate a System Log with the list of errors for further troubleshooting.

Shaded Modules = Reporter is out of calibration.

Available Assays

Assay Name	Version	Assay Type
Xpert FII	1	In Vitro Diagnostic
Xpert FII & FV Combo	1	In Vitro Diagnostic
Xpert FV	1	In Vitro Diagnostic

GeneXpert® Dx System Version 6.2 CONFIDENTIAL Page 1 of 2

Figure 2-84. Example Installation Qualification Report—Page 1

GeneXpert PC	03/20/20 13:04:15
GeneXpert® Dx System Installation Qualification Report	
Installation of networked instruments complies with the setup requirements specified in the GeneXpert® Dx System Operator Manual, 'Installation' section.	
_____	_____
Verified by	Date
This IQ is acceptable if all System Information and Instrument Information are listed as 'Pass'. All instrument modules that are listed as 'Pass' are available for use.	
Acceptance: [] Acceptable [] Not Acceptable	
_____	_____
Performed by	Date
_____	_____
Reviewed and approved by	Date
GeneXpert® Dx System Version 6.2	CONFIDENTIAL
	Page 2 of 2

Figure 2-85. Example Installation Qualification Report—Page 2

2.16 Managing Assay Definitions and Lot Specific Parameters

Note

This section describes tasks that all users with the appropriate permissions can perform. User permissions are described in [Section 2.13, Defining Users and Permissions](#). For this section, the screen shots will show a Detail user level.

An assay definition contains a series of programmed steps that the GeneXpert Dx system uses to perform sample preparation, amplification and detection procedures. *In vitro* diagnostic assay definition (.gxa/.nxa) files can be obtained from Cepheid and imported into the software (see [Section 2.16.2, Importing Assay Definitions](#)). Assay definitions that are no longer in use can also be deleted (see [Section 2.16.3, Deleting Assay Definitions](#)).

Some assay definitions require lot specific parameters to determine the test results. The 2D cartridge barcodes contain the lot specific parameter information that is automatically imported when a barcode is scanned. If, for some reason, the barcode scanner is not working or is not available, the lot specific parameter information can be supplied manually by importing the .gxr/.nxr file (see [Section 2.16.4, Importing Lot Specific Parameters Manually](#)). The lot specific parameter information that is no longer in use can also be deleted (see [Section 2.16.5, Deleting Lot Specific Parameters](#)).

2.16.1 Connecting and Using the DVD Drive

The DVD drive can be either an external drive which must be connected to the system using a USB port, or an internal drive, already installed in the system.

2.16.1.1 Connecting an External DVD Drive to the GX Dx System

Connect the supplied external DVD drive to the GX Dx system as follows:

1. Locate the DVD drive. The DVD drive is shipped in the accessories box and is labeled as an item to save.
2. Plug the DVD drive into one of the available USB ports on the system.
3. Press the **Eject** button on the front of the DVD drive to open the door.
4. The CDROM is located in the assay kit. Insert the assay definitions CD into the DVD drive and close the DVD drive door. The green light on the front of the DVD drive will flash while the drive reads the CD.

Import the assay definitions following the procedure in [Section 2.16.2](#).

2.16.1.2 Using the Internal DVD Drive in the GX Dx System

If a DVD drive is installed in the system, use the following procedure to access the drive.

1. Locate the DVD drive. The drive is installed on the GeneXpert Dx system computer but the location of the drive will vary:
 - On a desktop computer, the drive will be accessed from the front of the computer, and
 - on a laptop, the drive will be on the side of the laptop.
2. Press the **Eject** button on the front of the DVD drive to open the door.
3. The CDROM is located in the assay kit. Insert the assay definitions CD into the DVD drive and close the DVD drive door. The green light on the front of the DVD drive will flash while the drive reads the CD.

Import the assay definitions following the procedure in [Section 2.16.2](#).

2.16.2 Importing Assay Definitions

Note

Although *in vitro* diagnostic assay definitions can be imported, the GeneXpert Dx software does not allow the assay definitions to be modified.

To import new assay definitions:

1. In the GeneXpert Dx System window, click **Define Assays** on the menu bar. The Define Assays window appears. [Figure 2-88](#) shows the Define Assay window for the GeneXpert Dx system administrator. The window for Detail and Basic users has fewer functions (see [Figure 2-86](#)).

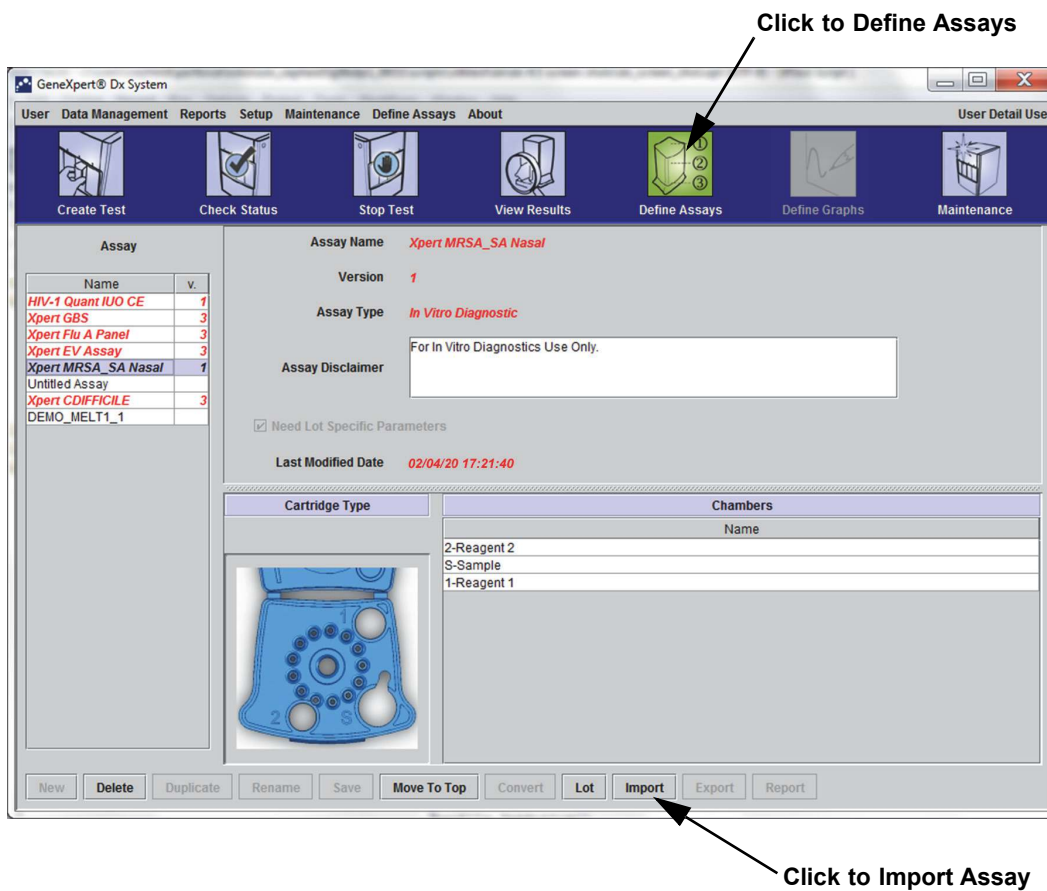

Figure 2-86. System—Define Assays Window (Detail User View)

2. Click **Import**. The Import Assay dialog box appears. See [Figure 2-87](#).

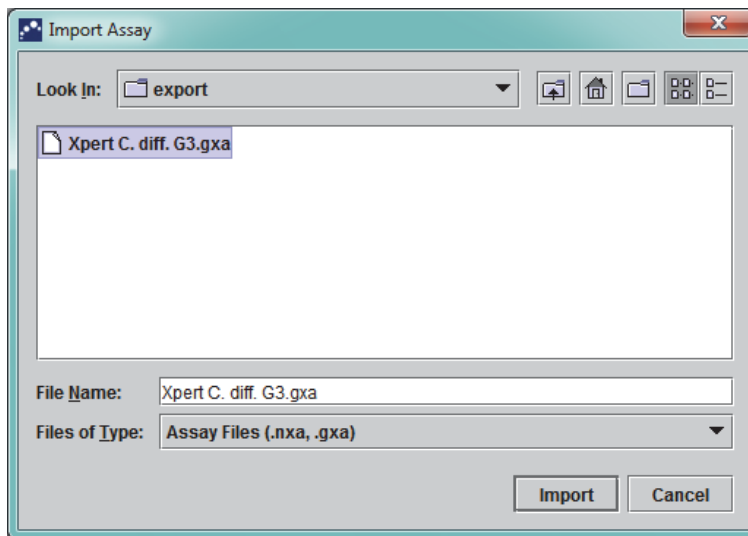

Figure 2-87. Import Assay Dialog Box

3. Navigate to the DVD folder. Locate and select the assay definition (.gxa/.nxa) file, and then click **Import**. The new assay name and version number appear in the Assay list (on the left side of the window) and details about the assay appear to the right of the list. See [Figure 2-86](#).
4. Check the assay name and version number to make sure the correct assay definition has been imported.
5. If you need to import additional assay definition files from the same CD, repeat [Step 2](#) through [Step 4](#).

Note

For combination assays that have multiple .gxa/.nxa files, import only the assay definition files for assays that will be performed in your lab.

6. Remove the CD from the DVD drive and store the CD in a safe location in the event it is needed in the future.
7. If an external DVD drive has been used and is no longer needed, disconnect it from the system and store the drive and associated cables for use in the future.

Note

After importing a quantitative assay, the Quantitative Result Unit can be changed. See [Figure 2-88](#).

2.16.3 Deleting Assay Definitions

Caution



Deleting assay definitions from the system is a permanent operation. Ensure that the assay definitions are no longer needed. If they are needed, they will need to be imported again from the assay definitions CDROM.

1. To delete an assay definition file, in the Define Assays window (see Figure 2-88), select the assay name in the Assay list (on the left side of the window), and then click **Delete**. A confirmation message appears.
2. Click **Yes** to delete the assay definition. The assay definition file will be deleted and is removed from the list of assays.

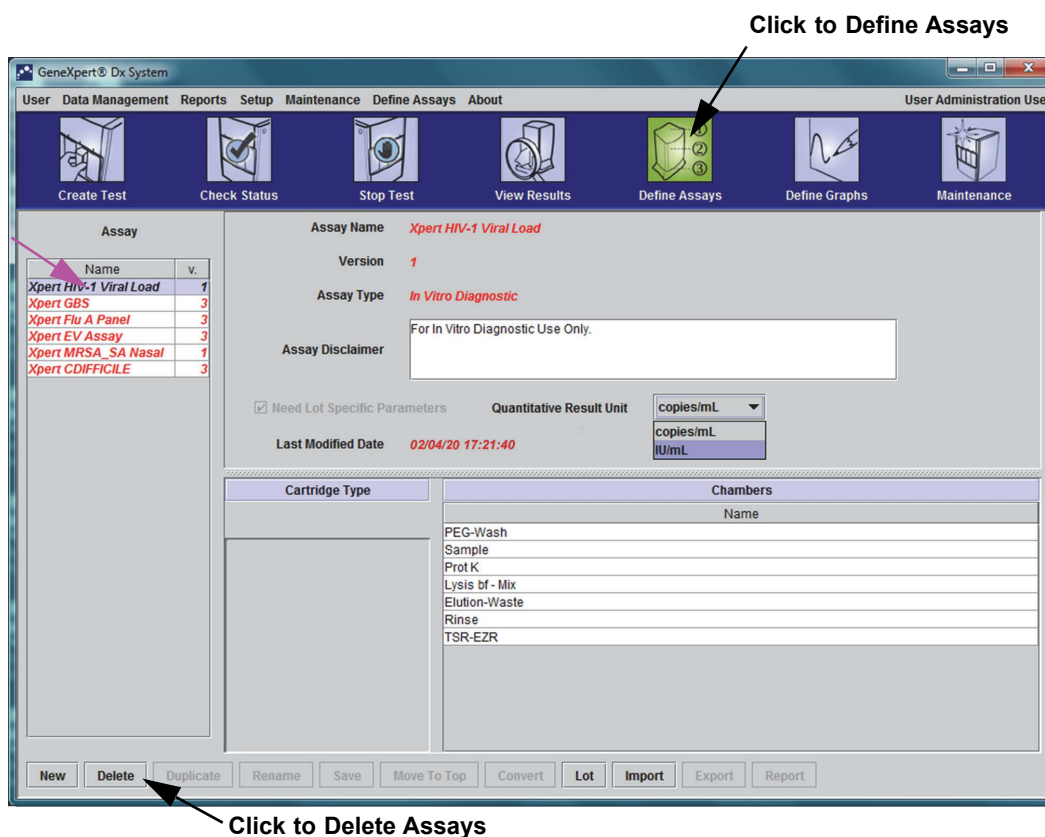

Figure 2-88. GeneXpert Dx System—Define Assays Window (Administrator User View)

2.16.4 Importing Lot Specific Parameters Manually

Some assay definitions require lot specific parameters to determine the test results. The cartridge barcodes contain the lot specific parameter information that is automatically imported when you scan the barcode when creating a test or defining assay. If, for some reason, the barcode scanner is not working or is not available, you can supply the lot specific parameter information manually by importing the .gxr/.nxr file.

Note

Contact Cepheid Technical Support to obtain the .gxr/.nxr files. After obtaining the .gxr/.nxr files, store them on the computer and note where the files are located (typically stored in the export folder).

To check if a specific assay requires Lot Specific Parameters, see if the box is checked for the assay to the left of the **Need Lot Specific Parameters** entry on the Define Assays screen.

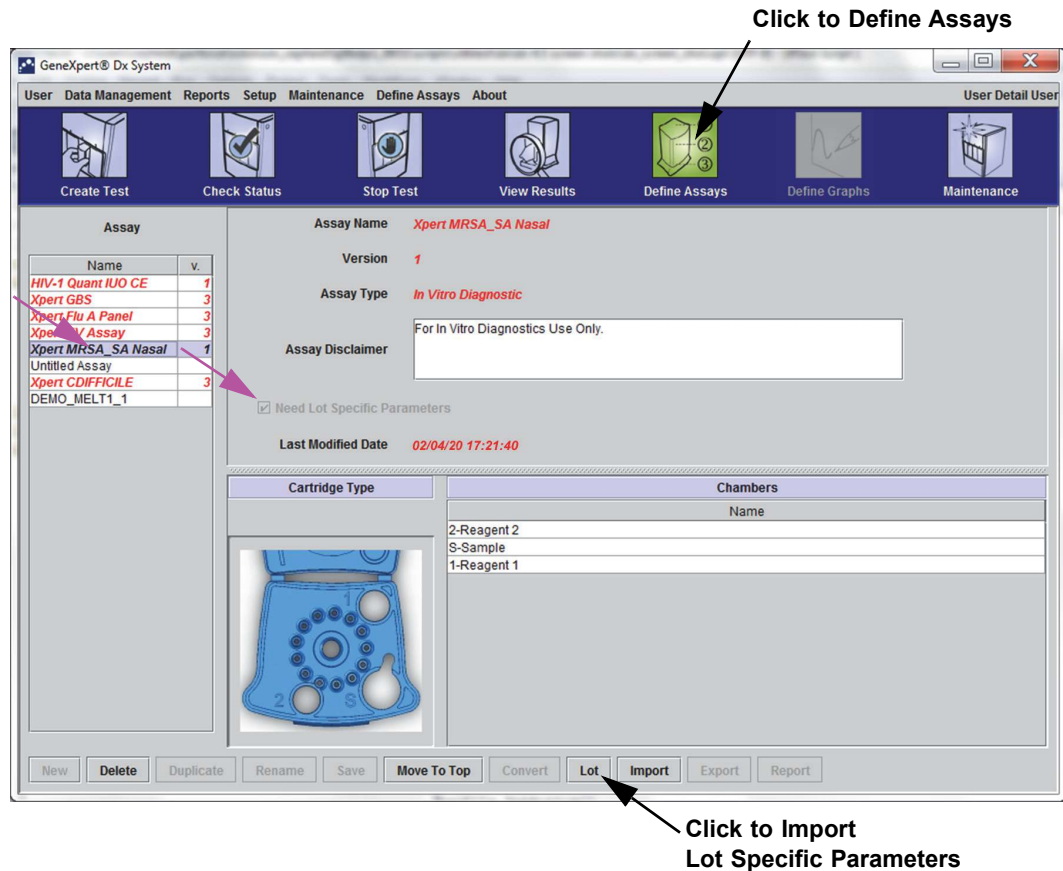

Figure 2-89. Define Assays Window, showing Need Lot Specific Parameters Box Checked

To import lot specific parameters manually:

1. In the Define Assays window (see [Figure 2-89](#)), select the assay name in the **Assay** list (on the left side of the window).
2. Click **Lot**. The Reagent Lot Specific Parameters dialog box appears. See [Figure 2-90](#).
3. Click **Import**. The Import Reagent Lot Specific Parameters dialog box appears.

Note

[Figure 2-90](#) shows the common Reagent Lot Number before importing specific lots. If assays and/or lot specific parameters have already been imported into the system, the reagent lot numbers will be displayed.

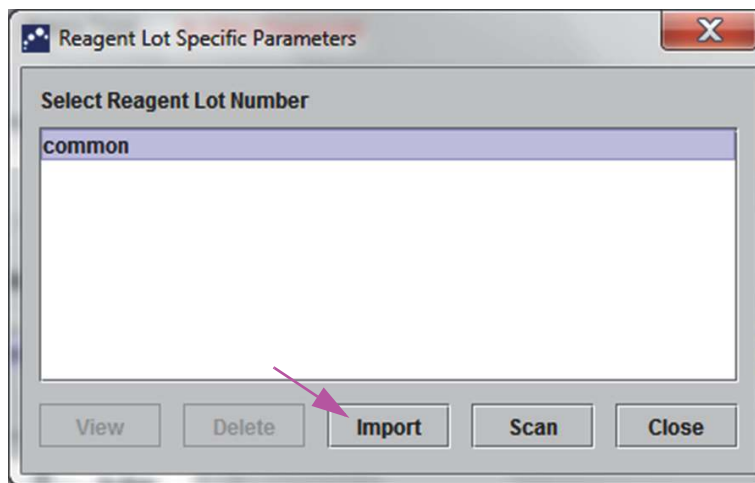

Figure 2-90. Reagent Lot Specific Parameters Dialog Box

4. Using the Look In: file viewing area, (see [Figure 2-91](#)) locate and select the .gxr/.nxr file obtained from Technical Support previously, and then click **Open**. The new lot number appears in the Reagent Lot Specific Parameters dialog box. Click **Close** in the Reagent Lot Specific Parameters dialog box to return to the Define Assays window.

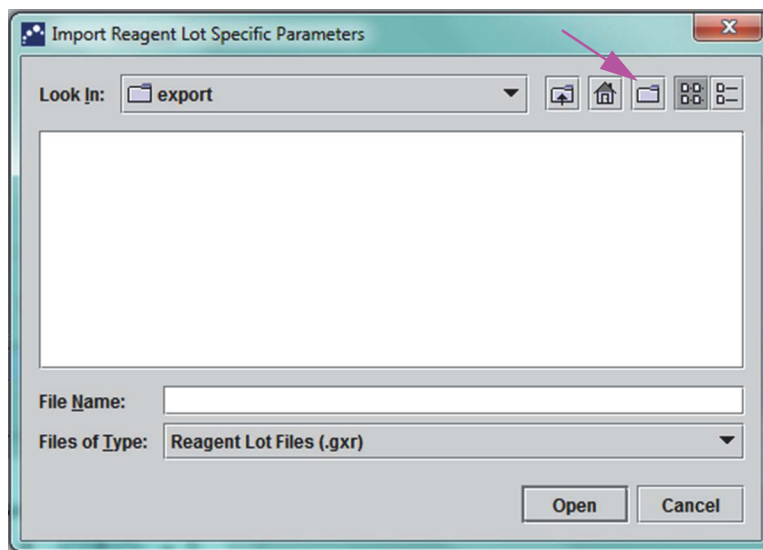

Figure 2-91. Import Reagent Lot Specific Parameters Dialog Box

2.16.5 Deleting Lot Specific Parameters

To delete lot specific parameters:

1. In the **Define Assays** window (see [Figure 2-89](#)), click **Lot**. The Reagent Lot Specific Parameters dialog box appears. See [Figure 2-90](#).

Note

Be aware that you cannot delete the **common** lot.

2. Select the lot number to be deleted, and then click **Delete**. A confirmation message appears.
3. Click **OK** to delete the lot specific parameters.
4. Click **Close** to close the Reagent Lot Specific Parameters dialog box.

2.17 Restarting the System

Note This section describes tasks that all user types can perform.

Under some troubleshooting scenarios (see [Section 9.19.2, Error Messages](#)), the system may need to be restarted. To do this, perform the steps in [Section 2.17.1](#) through [Section 2.17.2](#).

2.17.1 Shutting the System Down

1. Make sure the instrument is not currently processing any samples. Wait for the instrument to finish all processes before shutting down or restarting the system.
2. Remove the cartridges from the instrument modules.
3. Close the GeneXpert Dx software by clicking **Exit** on the **User** menu.

2.17.1.1 Archive Overdue Reminder

If an archive is not overdue, or if an archive setting in [Figure 2-77](#) is **not** selected, [Figure 2-92](#) will not appear, and you can skip directly to [Section 2.17.1.2](#).

If an archive is overdue, the Test Archive Reminder dialog box will appear (see [Figure 2-92](#)).

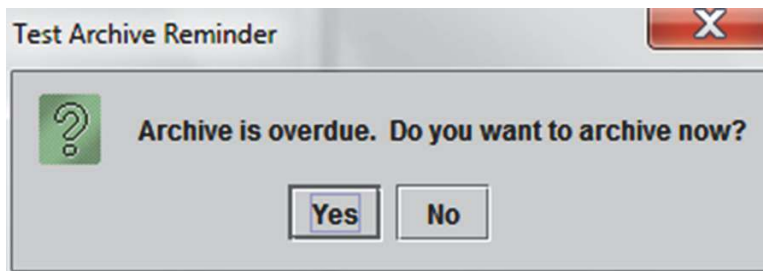

Figure 2-92. Test Archive Reminder Dialog Box

- If you do not want to archive, click **No** in the Test Archive Reminder dialog box (see [Figure 2-92](#)). Continue the shutdown sequence without archiving, in [Section 2.17.1.2](#).
or
- If you would like to archive, click **Yes** in the Test Archive Reminder dialog box (see [Figure 2-92](#)) to continue the shutdown sequence with archiving. The Select Test(s) To Be Archived screen appears. See [Figure 2-93](#).

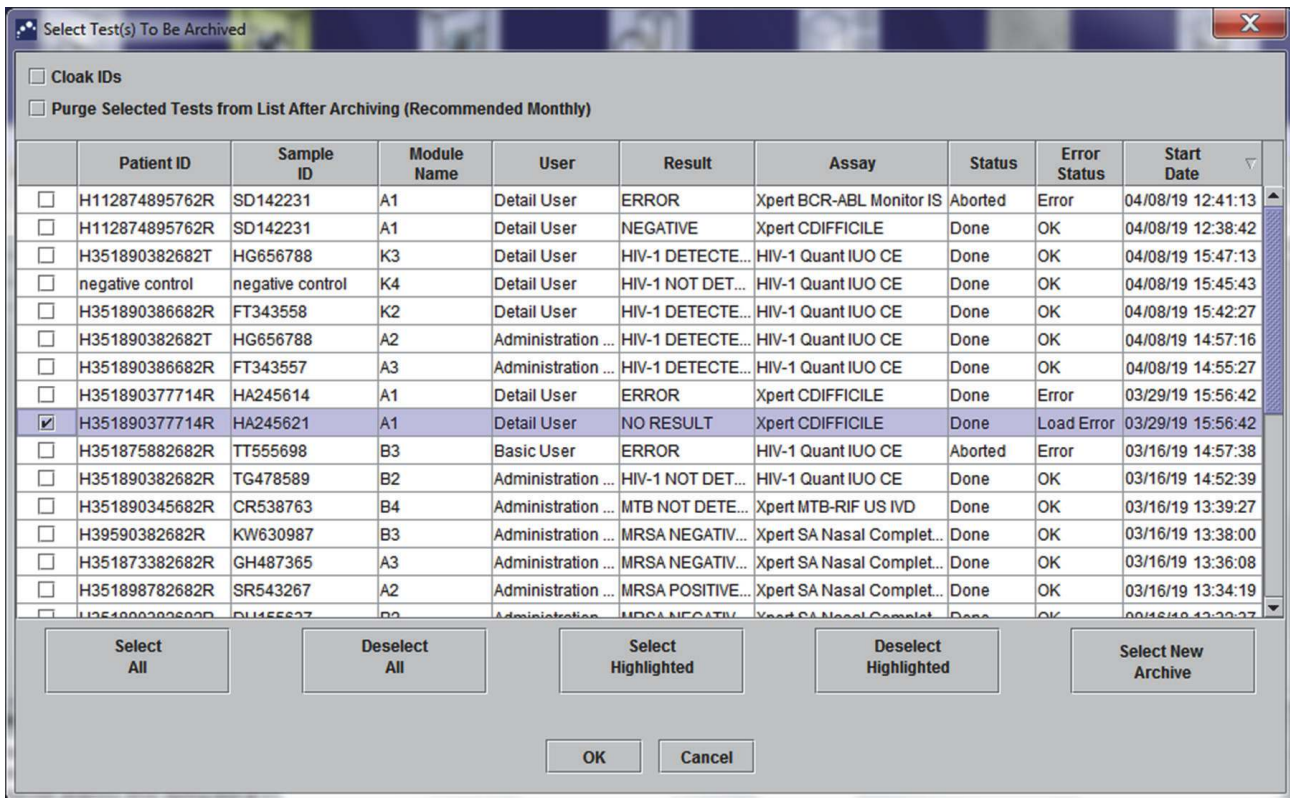

Figure 2-93. Select Test(s) To Be Archived Screen

To archive tests, perform [Step 2](#) through [Step 7](#) of the procedure in [Section 5.16.1, Archiving the Tests](#). When you are finished with the archiving, continue with [Section 2.17.1.2](#).

2.17.1.2 Database Management Reminder

- If the **Database Management Reminders** box on the System Configuration dialog box (see [Figure 2-76](#)) is **not** checked, the Database Management Dialog Box (see [Figure 2-94](#)) will not appear, and no further action will be required. The software will close when the **Exit** button is clicked in [Section 2.17.1, Step 3](#), and you can skip to [Section 2.17.1.3](#) to complete the shutdown sequence.

or

- If the **Database Management Reminders** box on the System Configuration dialog screen (see [Figure 2-76](#)) is checked, the Database Management dialog box (see [Figure 2-94](#)) will then appear on top of the GeneXpert Dx System window, asking if you want to perform Database Management tasks.

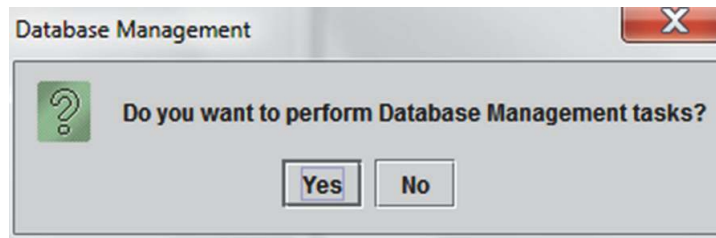

Figure 2-94. Database Management Dialog Box

- A. If you click **No** on the Database Management dialog box (see [Figure 2-94](#)), the GeneXpert Dx software closes and you can proceed to [Section 2.17.1.3](#) to complete the shutdown sequence.
or
- B. Click **Yes** in the Database Management dialog box (see [Figure 2-94](#)), and you will be asked to select the task to be performed (see [Figure 2-95](#)).

Note

Depending on the user's privileges, all (or some) of the four options in the Database Management dialog box may not be visible. See [Figure 2-95](#).

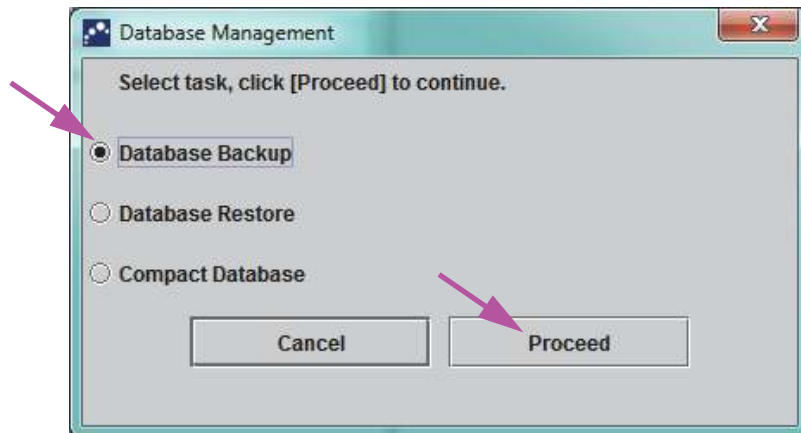

Figure 2-95. Database Management Dialog Box

See [Section 5.17, Performing Database Management Tasks](#) for details on how to perform each of the database management tasks. After completion of the Database Management tasks, the GeneXpert Dx software closes and the Windows desktop is displayed.

Proceed to [Section 2.17.1.3](#).

2.17.1.3 Final Shutdown Steps

1. Turn off the instrument
2. Shut down the GeneXpert Dx system computer.

2.17.2 Restart the System

To restart the system, follow the procedure in [Section 5.2.2, Turning On The Computer](#).

Important

After the system has been powered off, wait two minutes before turning the system back on. The system may not boot up correctly if it is turned back on in less than two minutes.

2.18 Uninstalling or Reinstalling GeneXpert Dx Software

The GeneXpert Dx software is already installed on the supplied computer but may need to be reinstalled in certain situations, with assistance from Cepheid Technical Support.

Caution



If the software becomes corrupted or there is a system failure, do not attempt to reinstall the software. Call Cepheid Technical Support for assistance to minimize the chance of permanent data loss. See the [Technical Assistance](#) section in the [Preface](#) for the contact information.

3 Principles of Operation

This chapter explains how the GeneXpert Dx system works. The topics are as follows:

- [Section 3.1, System Operation Overview](#)
- [Section 3.2, GeneXpert Module](#)
- [Section 3.3, GeneXpert Cartridge](#)
- [Section 3.4, I-CORE Module](#)
- [Section 3.5, Heating and Cooling Mechanisms](#)
- [Section 3.6, Explanation of Experimental Methods](#)
- [Section 3.7, Optical System](#)
- [Section 3.8, System Calibration](#)

3.1 System Operation Overview

GeneXpert Dx systems automate and integrate sample purification, nucleic acid amplification, and detection of the target sequence using real-time reverse transcriptase PCR (RT-PCR) and real-time PCR assays.

Each GeneXpert Dx module processes one sample. The sample and applicable reagents are inserted into a GeneXpert cartridge and a test is created on the GeneXpert Dx system (see [Section 5.6, Creating a Test](#)) to run the test. The cartridge is then loaded into an available instrument module (see [Section 5.7, Loading a Cartridge into an Instrument Module](#)) and then is started (see [Section 5.8, Starting the Test](#)). During the test, the system performs the following steps:

1. Moves the sample and reagents into different chambers in the cartridge for sample preparation.
2. Hydrates the reagent beads.
3. Performs probe checks to ensure that the sample preparation is successful (only if the assay definition requires this step).
4. Moves the sample and the reagent mixture which contains reverse transcription (if applicable) and real-time PCR specific components into the reaction tube.
5. Starts the RT-PCR (if applicable) and PCR cycles and real-time detection (see [Figure 3-1](#)).

The GeneXpert Dx System uses the I-CORE[®] module heating and fan cooling system to perform the real-time polymerase chain reaction used to exponentially amplify and detect the organism's DNA or cDNA sequence of interest.

Polymerase chain reaction is an amplification method that increases quantities of specific copies of DNA or cDNA sequences. Real-time polymerase chain reaction uses fluorescence to detect the specific sequences and includes a mechanism to determine the cycle at which the DNA or cDNA of interest first appears at appreciable copies (called the cycle threshold).

Polymerase chain reaction consists of a series of cycles during which the DNA or cDNA is heated and cooled at specific temperatures for a certain duration.

After **Initial Denaturation** (when the polymerase used to amplify the DNA or cDNA is activated) a cycle occurs, which is illustrated as a three-step process consisting of:

1. The **Denaturation** step which divides the DNA strands.
2. An **Annealing** step in which a primer is needed by the polymerase to amplify the DNA. The primer will bind to the DNA or cDNA sequence if complementary.
3. The **Extension** step, where the DNA strands will be extended.

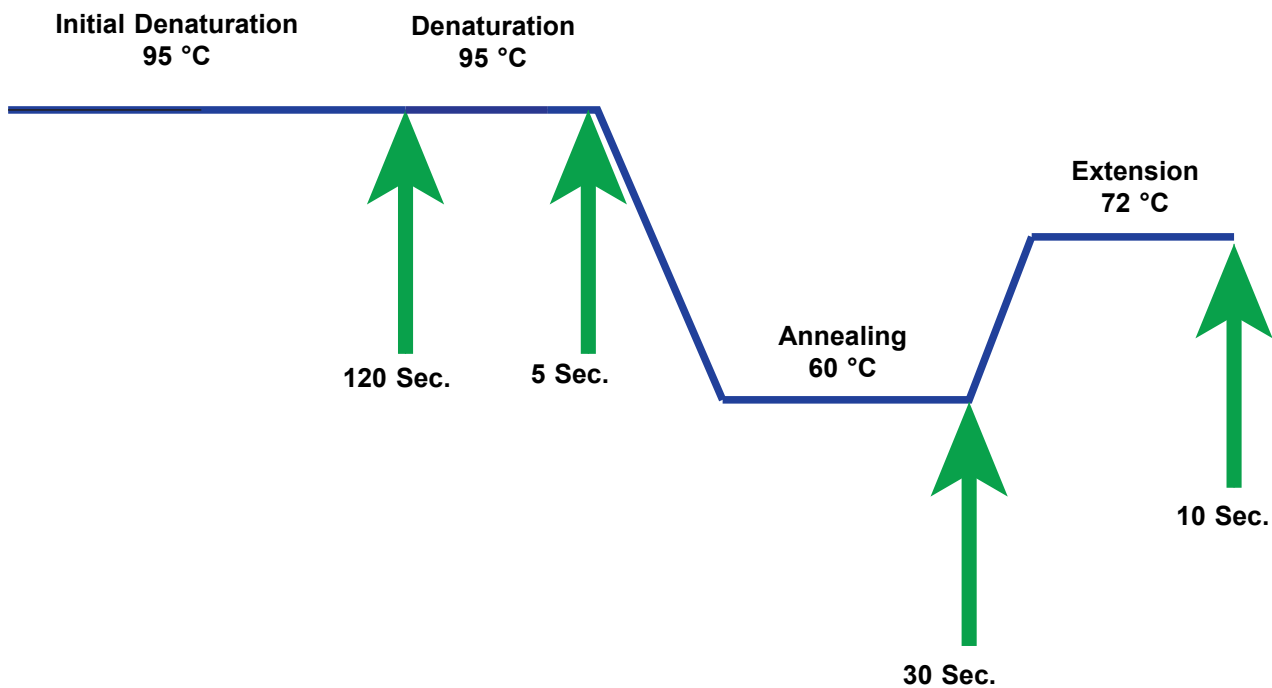

Figure 3-1. Example PCR Cycle Diagram for I-CORE Module Heating and Fan Cooling (Temperature Durations not to Scale)

3.2 GeneXpert Module

The PCR cycle diagrammed in [Figure 3-1](#) indicates 40 cycles performed by the I-CORE module. The denaturation temperature is 95 °C; the annealing temperature is 60 °C; and, the extension temperature is 72 °C. Each of these temperatures must be held by the module for a specific duration, as indicated in [Figure 3-1](#). The initial denaturation takes place for 120 seconds for one cycle. The denaturation (5 seconds), annealing (30 seconds) and extension (10 seconds) steps cycle consecutively forty times before the polymerase chain reaction is finally completed.

Each instrument module contains the following components that enable automated sample processing in the cartridge and filling of the tube with the sample-reagent mixture for PCR:

- **Valve Drive**—Rotates the cartridge valve body to address the different cartridge chambers.
- **Plunger Rod**—Dispenses fluids into the different cartridge chambers.
- **Ultrasonic Horn**—Lyses the sample (if applicable).
- **I-CORE Module**—Performs PCR amplification and detection.

A cartridge loading and unloading mechanism assures the proper movement of the cartridge in the instrument. In addition, the system is designed to perform a self-test before each test starts to verify that the system is functioning properly.

3.3 GeneXpert Cartridge

The disposable, single-use GeneXpert cartridge holds the samples and reagents that are to be processed in the GeneXpert Dx system. Each cartridge consists of the following components (see [Figure 3-2](#)):

- **Processing Chambers**—Hold the samples, reagents, processed sample, and waste solutions. One chamber is designated as an air chamber to equilibrate pressures within the cartridge.
- **Valve Body**—Rotates and allows fluid to move to different cartridge chambers and to the reaction tube. Within the valve body, the specimen is isolated, PCR inhibitors are removed, and specimens are ultrasonically lysed (if applicable). After the sample is processed, it is mixed with PCR reagents and moved into the integrated reaction tube.
- **Reaction Tube**—Enables rapid thermal cycling and optical excitation and detection of the tube contents. The reaction tube is automatically inserted into the I-CORE module when the cartridge is loaded into the instrument.

The cartridge is designed to keep the reagent contained within the cartridge. It is a closed-system vessel.

The GeneXpert cartridges are not supplied with the system. To order the assay-specific cartridges, contact Cepheid. See the [Technical Assistance](#) section in the [Preface](#) for the contact information.

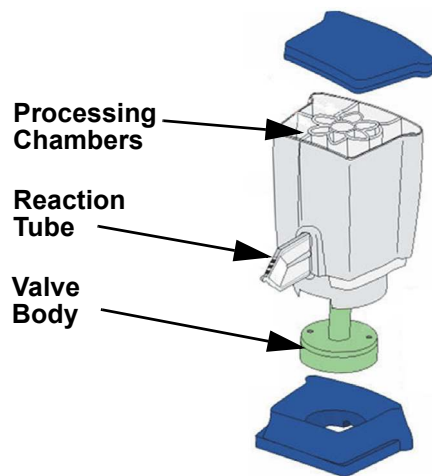

Figure 3-2. GeneXpert Cartridge Components

3.4 I-CORE Module

The I-CORE (Intelligent Cooling/Heating Optical Reaction) module is the hardware component within each instrument module that performs PCR amplification and fluorescence detection. As part of the cartridge load process, the reactor tube is inserted into the I-CORE module (see Figure 3-3). The sample and reagent mixture are pushed from the cartridge into the reaction tube. During the amplification process, the I-CORE heater heats up and the fan cools down the reaction tube contents. The optical blocks excite the dye molecules and detect the fluorescence emitted.

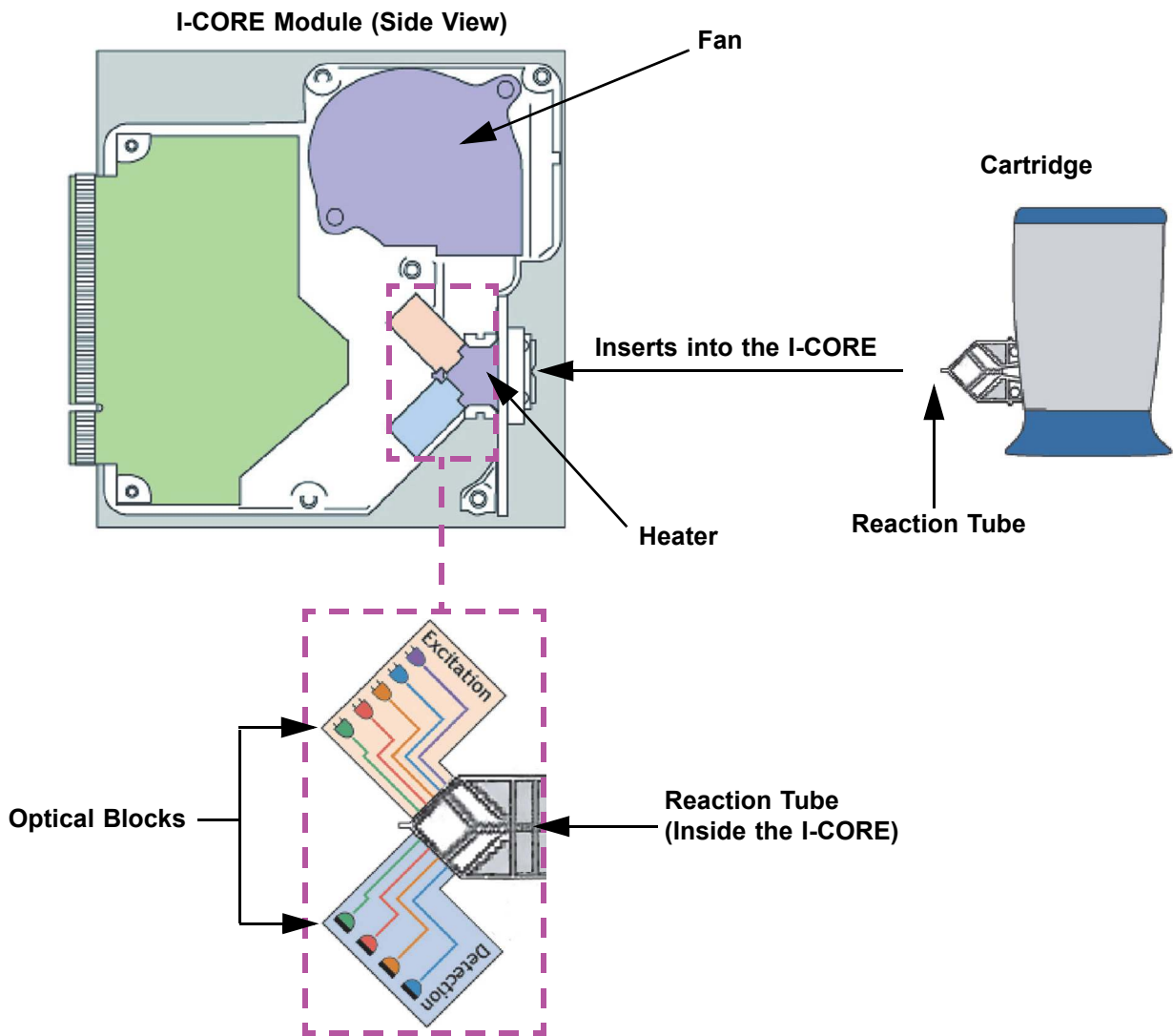

Figure 3-3. I-CORE Module

3.5 Heating and Cooling Mechanisms

Within the I-CORE, the heater consists of two ceramic plates that have high thermal conductivity to assure temperature uniformity and rapid heat transfer (see [Figure 3-3](#)). Resistive heater elements are deposited on the ceramic plates using thick film technologies and a thermistor attached directly to each plate monitors its temperature. A high-efficiency fan cools the reaction tube contents by moving ambient air across the heater plates. During thermocycling, the instrument firmware controls the temperature inside the instrument module. The firmware incorporates a control loop to ensure rapid heating of the plates while minimizing the temperature overshoot around the desired target temperature.

3.6 Explanation of Experimental Methods

The GeneXpert system uses real-time polymerase chain reaction (real-time PCR) to detect the organism's DNA of interest.

Real-time polymerase chain reaction is a variant of polymerase chain reaction and uses the same method of PCR with denaturation, annealing and extension at specified time durations to amplify DNA. Real-time PCR uses fluorescence in the form of either intercalating dyes or probes to detect amplified copies of the DNA of interest and to visualize and monitor the amplified product in real time.

In real-time PCR, primers specifically designed to be complementary to the organism's DNA bind to the DNA and extend it. For example in 5'-nuclease technology, a probe which has a reporter dye and quencher attached to it is also complementary to the organism's DNA and binds to the DNA downstream to the primer. The primer and probe together add a higher level of specificity to identify a sequence specific to the organism.

As the DNA strand is extended, the probe is destroyed and the reporter and quencher are dissociated and become free in solution. The fluorescent signal becomes detected and increases with each amplification.

The cycle at which the fluorescence becomes detected after appreciable copies of the DNA are made is the cycle threshold (Ct). The most basic definition of a cycle threshold is the first cycle in which there is significant increase in fluorescence above the background fluorescence (see [Figure 3-4](#)).

The real-time PCR generates a growth curve with number of cycles on the x-axis and fluorescence on the y-axis. The increase in fluorescence is proportional to the amount of amplicon generated and can be used to define cycle threshold. As the growth curve plateaus, it will reach a fluorescent end-point at which other factors are rate-limiting. If the organism's DNA is not detected by the real-time PCR reaction, the growth curve will be flat.

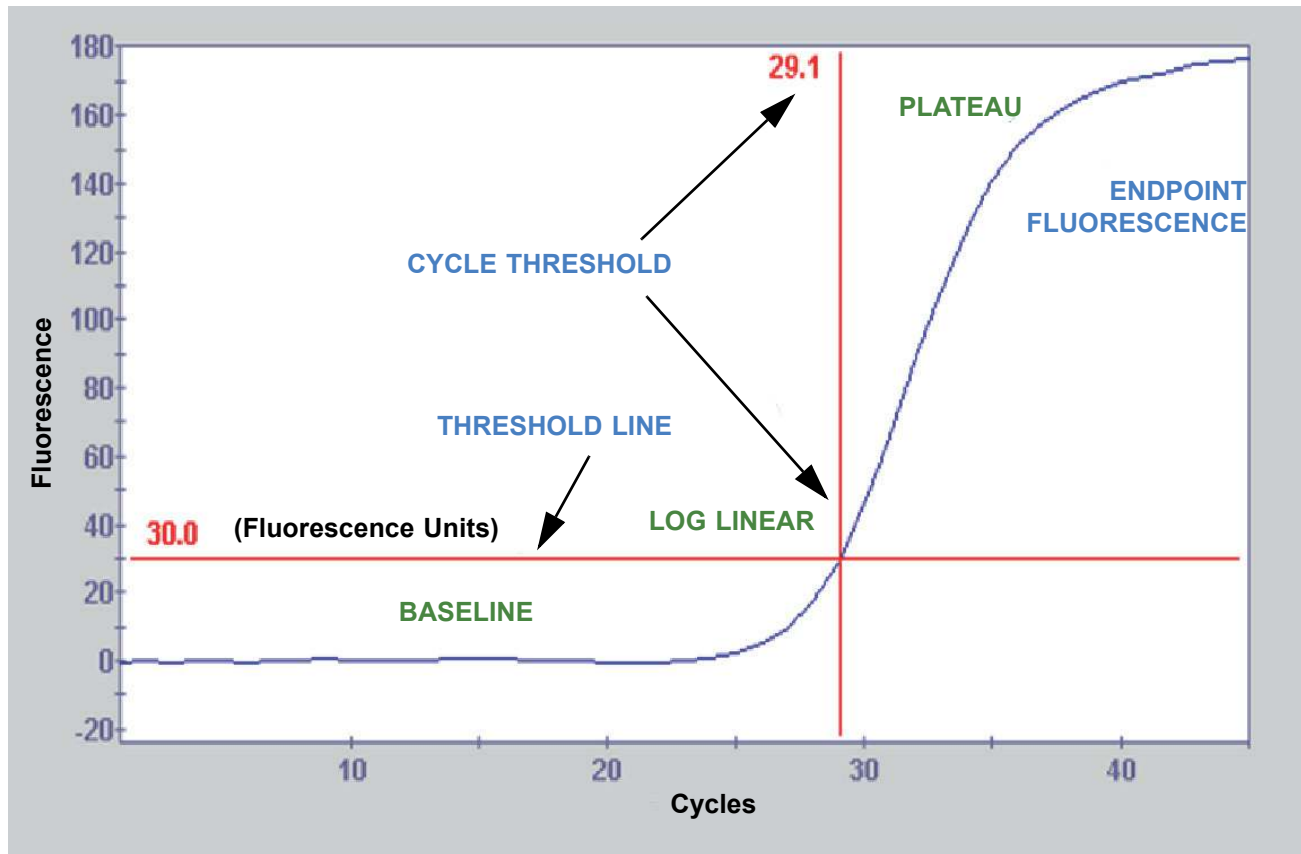

Figure 3-4. Amplification Curve and Cycle Threshold (Ct)

3.7 Optical System

The modules used for both 6-color and 10-color use the same hardware. They can be calibrated as either 6-color or 10-color. The GeneXpert Dx system may have six-color modules or they may have 10-color modules. See the following sections depending upon which type of modules are installed in the system:

- [Section 3.7.1, Six-Color Modules](#)
- [Section 3.7.2, Ten-Color Modules](#)

3.7.1 Six-Color Modules

Within the I-CORE, the optical system consists of two blocks (see [Figure 3-3](#)):

- **Six-color exciter module**—Contains high intensity light-emitting diodes (LEDs) to excite the reporter dye molecules.
- **Six-color detector module**—Contains silicon photodetectors and filters to detect the six spectral bands.

The optical blocks are positioned within the I-CORE such that their apertures mate with the optical windows of the reaction tube, allowing excitation and emission detection of the reaction mixture. By using probes labeled with different fluorescent reporter dyes, up to six targets can be detected simultaneously in a single reaction tube. The emission spectra of fluorescent dyes can overlap, and a particular dye could produce a signal in more than one channel. To compensate for the spectral overlap, the system uses appropriate calibration and data analysis algorithms to determine the concentrations of each reporter dye. [Table 3-1](#) shows the excitation and detection spectral bands for the six channels.

Table 3-1. GeneXpert Module Excitation and Emission Ranges (6-Color)

Optical Channel	Excitation (nm)	Emission (nm)
1	375-405	420-480
2	450-495	510-535
3	500-550	565-590
4	555-590	606-650
5	630-650	665-685
6	630-650	>700

3.7.2 Ten-Color Modules

Note

Ten-color modules require GeneXpert Dx software version 6.2 or later. Should you need any assistance, please contact your regional Cepheid Technical Support center.

Within the I-CORE, the optical system consists of two blocks (see [Figure 3-3](#)):

- **Ten-color exciter module**—Contains high intensity light-emitting diodes (LEDs) to excite the reporter dye molecules.
- **Ten-color detector module**—Contains silicon photodetectors and filters to detect the ten spectral bands.

The optical blocks are positioned within the I-CORE such that their apertures mate with the optical windows of the reaction tube, allowing excitation and emission detection of the reaction mixture. By using probes labeled with different fluorescent reporter dyes, up to ten targets can be detected simultaneously in a single reaction tube. The emission spectra of fluorescent dyes can overlap, and a particular dye could produce a signal in more than one channel. To compensate for the spectral overlap, the system uses appropriate calibration and data analysis algorithms to determine the concentrations of each reporter dye. [Table 3-2](#) shows the excitation and detection spectral bands for the ten channels.

Table 3-2. GeneXpert Module Excitation and Emission Ranges (10-Color)

Optical Channel	Excitation (nm)	Emission (nm)
1	375-405	420-480
2	450-495	510-535
3	500-550	565-590
4	555-590	606-650
5	630-650	665-685
6	630-650	>700
7	450-495	565-590
8	500-550	606-650
9	450-495	606-650
10	500-550	>700

3.8 System Calibration

The thermal reaction chamber thermistors are calibrated to ± 1.0 °C using National Institute of Standards and Technology (NIST) traceable standards. During the manufacturing process, the temperature of the heating system is measured at two temperatures: 60 °C and 95 °C. Calibration coefficients that correct for small errors in the raw thermistor readings of the heaters are stored in the memory of each I-CORE module.

The optical system is calibrated using standard concentrations of individual unquenched fluorescent dye-oligos. For each optical channel, the signal produced by a tube alone (the blank signal) is subtracted from the raw signal produced by the dye-oligo standard to determine the spectral characteristics. Using the individual spectral characteristics of the pure dye-oligos, signals from an unknown mixture of dye-oligos can be resolved into corrected signals for the individual dye-oligos in the mixture.

4 Performance Characteristics and Specifications

This chapter presents the GeneXpert Dx system performance characteristics and specifications. The topics are as follows:

- [Section 4.1, Instrument Classification](#)
- [Section 4.2, General Specifications](#)
- [Section 4.3, Operational Environmental Parameters](#)
- [Section 4.4, Environmental Conditions—Storage and Transport](#)
- [Section 4.5, Sound Pressure](#)
- [Section 4.6, European Union Directives](#)
- [Section 4.7, Table of Hazardous Substance’s Names and Concentrations](#)
- [Section 4.8, Product Energy Consumption Information](#)
- [Section 4.9, Heat Output](#)

4.1 Instrument Classification

The GeneXpert Dx system is:

- An Industrial Scientific Medical Device (ISM) instrument, medium-sized, for industrial and laboratory use.
- Designed for stationary operation.
- Intended for worldwide use.
- Intended for evaluating preprocessed biological material.

4.2 General Specifications

4.2.1 General Specifications for GeneXpert R1 Instruments

The GeneXpert R1 instruments have the following specifications:

- **Dimensions and Weight:**

Table 4-1. Dimensions and Weight

Instrument	Width	Height	Depth	Weight
GX-I R1	10.8 cm (4.2 in)	34.29 cm (13.5 in)	34.29 cm (13.5 in)	8.16 kg (18 lb)
GX-IV R1	29.8 cm (11.75 in)	35.6 cm (14 in)	31.1 cm (12.25 in)	12 kg (26 lb)
GX-XVI R1	53 cm (21 in)	76 cm (30 in)	38 cm (15 in)	57 kg (125 lb)

- **Power Supply:** Auto-ranging
- **Rated AC Voltage Range:** 100–240 V~, 50–60Hz
- **Mains Supply Fluctuations:** Up to $\pm 10\%$ of the nominal voltage
- **Transient Over-Voltages:** Up to 2500 V peak (impulse withstand category II)
- **Rated Current and Fuse Rating:**

Table 4-2. Rated Current and Fuse Rating

Instrument	Rated Current	Fuse Rating
GX-I R1	1.5A @ 100V~, 0.75A @ 200V~	250 V~ T2A (IEC 60127 time-delay type)
GX-IV R1	1.9A @ 100V~, 0.95A @ 200V~	250 V~ T3A (IEC 60127 time-delay type)
GX-XVI R1	8.24A @ 100V~, 4.12A @ 200V~	250 V~ T6.3A (IEC 60127 time-delay type)

4.2.2 General Specifications for GeneXpert R2 Instruments

The GeneXpert R2 instruments have the following specifications:

- **Dimensions and Weight:**

Table 4-3. Dimensions and Weight

Instrument	Width	Height	Depth	Weight
GX-I R2	9.4 cm (3.7 in)	30.5 cm (12 in)	29.7 cm (11.7 in)	4 kg (9 lb)
GX-II R2	16.3 cm (6.4 in)	30.7 cm (12.1 in)	29.7 cm (11.7 in)	6.5 kg (15 lb)
GX-IV R2	28.2 cm (11.1 in)	30.5 cm (12 in)	29.7 cm (11.7 in)	11.4 kg (25 lb)
GX-XVI R2	53 cm (21 in)	65.8 cm (25.9 in)	33.8 cm (13.3 in)	57 kg (125 lb)

- **Power Supply:** Auto-ranging
- **Rated AC Voltage Range:** 100–240 V~, 50–60Hz
- **Mains Supply Fluctuations:** Up to $\pm 10\%$ of the nominal voltage
- **Transient Over-Voltages:** Up to 2500 V peak (impulse withstand category II)
- **Rated Current and Fuse Rating:**

Table 4-4. Rated Current and Fuse Rating

Instrument	Rated Current	Fuse Rating
GX-I R2	1.5A @ 100V~ (AC Adapter Output 2.5A @ 24Vdc)	No serviceable fuse
GX-II R2	1.5A @ 100V~ (AC Adapter Output 2.5A @ 24Vdc)	No serviceable fuse
GX-IV R2	1.4A @ 100V~	250V~ T3A (IEC 60127 time-delay type)
GX-XVI R2	6.16A @ 100V~	250V~ T6.3A (IEC 60127 time-delay type)

4.3 Operational Environmental Parameters

Your laboratory must meet the following requirements:

- **General Environment:** Indoor only
- **Pollution Degree:** 2
- **Operating Temperature:** 15–30 °C
- **Relative Humidity:** 10%–95%, non-condensing

Place the GeneXpert Dx system away from heat and air conditioning ducts. Do not place the instrument directly under an air vent or in direct sunlight. Always keep the instrument module doors closed when not in use.

4.4 Environmental Conditions—Storage and Transport

The required storage conditions are as follows:

- **Temperature:** –30 °C to +45 °C
- **Humidity:** 0%–95% relative humidity, non-condensing

4.5 Sound Pressure

The sound pressure specifications are as follows:

- **Audible Sound Pressure Range:** < 85 dB (reference level 20 µPa)
- **Ultrasonic Sound Pressure Between 20kHz to 100kHz:** < 94.5 dB SPL (reference level 20 µPa)
- **Maximum Sound Pressure:** Contained in the 40 kHz one-third octave bands

4.6 European Union Directives

The GeneXpert Dx systems have been designed and tested to conform to the laboratory equipment requirements of applicable regulatory agencies. Declaration of Conformity is available by contacting Cepheid Technical Support. See the [Technical Assistance](#) section in [Preface](#) for more information.

4.7 Table of Hazardous Substance's Names and Concentrations

Product Name: GeneXpert[®] Dx System

Product Model Number: GX-I R2, GX-II R2, GX-IV R2, GX-XVI R2

Component Name	Hazardous Substances Name					
	(Pb)	(Hg)	(Cd)	(Cr ⁶⁺)	(PBB)	(PBDE)
GeneXpert Disposable Cartridge	O	O	O	O	O	O
Cable Sub-Assemblies	O	O	O	O	O	O
Plastic Parts	O	O	O	O	O	O
Sheet Metal	O	O	O	O	O	O
Hardware (Screw, bolts, etc.)	O	O	O	O	O	O
Power Supply Sub Assembly	O	O	O	O	O	O
Printed Circuit Board Assemblies	X	O	O	O	O	O
Piezo Ultrasonic Transducer	X	O	O	O	O	O

This table is prepared in accordance with the provisions of SJ/T 11364-2014
O: Indicates that the toxic or hazardous substances contained in all of the homogeneous materials for this part is below the limit requirement in GB/T 26572.
X: Indicates that the toxic or hazardous substances contained in at least one of the homogeneous materials used for this part is above the limit requirement in GB/T 26572.

4.8 Product Energy Consumption Information

Supplier Name	Supplier Model Identifier	Energy Efficiency Class	On Mode Power Consumption (W)	Annual Energy Consumption (KWh)	Standby Power Consumption (W)
Cepheid	GeneXpert GX-I	G	61	263	58
Cepheid	GeneXpert GX-II	G	85	372	71
Cepheid	GeneXpert GX-IV	G	100	489	83
Cepheid	GeneXpert GX-XVI	G	270	1168	170

4.9 Heat Output

Supplier Name	Supplier Model Identifier	BTU/hr
Cepheid	GeneXpert I R2	208
Cepheid	GeneXpert II R2	290
Cepheid	GeneXpert IV R2	341
Cepheid	GeneXpert XVIR2	921

5 Operating Instructions

This chapter explains how to use the GeneXpert Dx system to run an *in vitro* diagnostic (IVD) test and manage the results data. The topics are as follows:

- Section 5.1, Typical Workflow
- Section 5.2, Getting Started
- Section 5.3, Using the System Window
- Section 5.4, Checking the List of Available Assay Definitions
- Section 5.5, Barcode Scanner Usage
- Section 5.6, Creating a Test
- Section 5.7, Loading a Cartridge into an Instrument Module
- Section 5.8, Starting the Test
- Section 5.9, Monitoring the Test Process
- Section 5.10, Stopping a Test in Progress
- Section 5.11, Viewing the Test Results
- Section 5.12, Editing the Test Information
- Section 5.13, Generating Test Result Reports
- Section 5.14, Exporting the Test Results
- Section 5.15, Uploading Test Results to the Host
- Section 5.16, Managing the Test Results Data
- Section 5.17, Performing Database Management Tasks
- Section 5.18, Purging Tests from the Database
- Section 5.19, Viewing and Printing Reports
- Section 5.20, Operating with Host Connectivity
- Section 5.21, Operating with Cepheid Link Connectivity
- Section 5.22, System Information

Support for Windows XP ended April 8, 2014. Microsoft no longer provides security updates or technical support for the Windows XP operating system. It is critical that you upgrade now to a newer operating system, such as Windows 10.

Important

Please contact <https://www.microsoft.com/en-us/microsoft-365/windows/end-of-windows-xp-support> for Windows XP support information.

In addition, please contact your local Cepheid Technical Support if you have questions about using Windows XP.

Support for Windows 7 ended January 14, 2020. Microsoft no longer provides security updates or technical support for the Windows 7 operating system. It is critical that you upgrade now to a newer operating system, such as Windows 10

Important

Please contact <https://www.microsoft.com/en-us/microsoft-365/windows/end-of-windows-7-support> for Windows 7 support information.

In addition, please contact your local Cepheid Technical Support if you have questions about using Windows 7.

5.1 Typical Workflow

Table 5-1 shows the typical workflow for processing a specimen sample using the GeneXpert Dx system.

Table 5-1. Typical Workflow for Processing a Specimen

Step	Task	Section
1.	Start the GeneXpert Dx System.	Section 5.2.3
2.	Perform Database Management Tasks.	Section 5.17
3.	Check the list of assays available. Import the assay definition files if necessary.	Section 5.4 and Section 2.16
4.	Prepare the assay-specific GeneXpert cartridge	See the Package Insert that is shipped with the cartridge.
5.	Create a test.	Section 5.6
6.	Load a cartridge into an instrument module.	Section 5.7
7.	Start the test.	Section 5.8
8.	Monitor the test progress.	Section 5.9
9.	View the test results.	Section 5.11
10.	Generate test result reports.	Section 5.13
11.	Export the test results.	Section 5.14
12.	Manage the test results data.	Section 5.16

5.2 Getting Started

This section describes the basic system tasks.

- [Section 5.2.1, Powering the Instrument On and Off](#)
- [Section 5.2.2, Turning On The Computer](#)
- [Section 5.2.3, Starting the Software](#)
- [Section 5.2.4, Logging On with Software Running](#)
- [Section 5.2.5, Logging Off](#)
- [Section 5.2.6, Changing Your Password](#)

5.2.1 Powering the Instrument On and Off

Note

The GeneXpert instrument must be powered up before the GeneXpert software is started. If the instrument is not powered up first, it will not be recognized by the software.

The power switch is located on the lower back side of the instrument. From the front of the instrument, the switch can be reached from either side.

To turn on the instrument(s), press the switch to the on position (I). The small blue light on the front of the instrument will turn on.

To turn off the instrument, press the switch to the off position (O).

Important

Cepheid recommends powering down the instrument and computer at least once per week.

5.2.2 Turning On The Computer

After the GeneXpert Dx system computer has been installed, use the following procedure to turn the computer on and log onto the computer.

1. Turn on the GeneXpert Dx system computer.
2. Wait for the system to boot.

On Windows 7, the Windows Account screen appears. See [Figure 5-1](#).

On Windows 10, the Windows Lock screen appears. See [Figure 5-2](#). Click anywhere on the screen to display the Windows Account and Password screen. See [Figure 5-1](#).



Figure 5-1. Windows 7 Account Screen

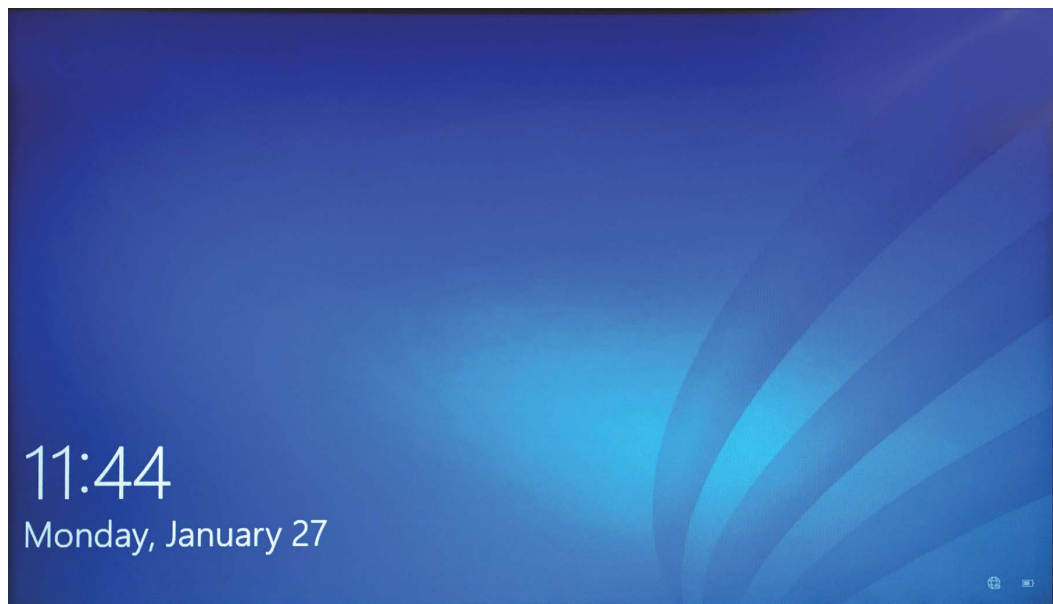

Figure 5-2. Windows 10 Lock Screen

3. On the Windows Account screen, select the **Cepheid-Admin** user account (see [Figure 5-1](#) and [Figure 5-4](#)).
 - On Windows 7, the Windows Password screen appears. See [Figure 5-3](#).
 - On Windows 10, the Cepheid user account password field appears. See [Figure 5-4](#).

The GeneXpert Dx system computer is configured with two Windows accounts. The **Cepheid-Admin** account is for administrator tasks such as software updates, system configuration and for normal operation; and the **Cepheid-Techsupport** account is for use only by Cepheid Technical Support. See [Figure 5-1](#) and [Figure 5-4](#).

Caution

You must be logged on using the preconfigured Cepheid account. If you log on using a different user name and profile, the power management settings will be incorrect.



Figure 5-3. Windows 7 Password Screen

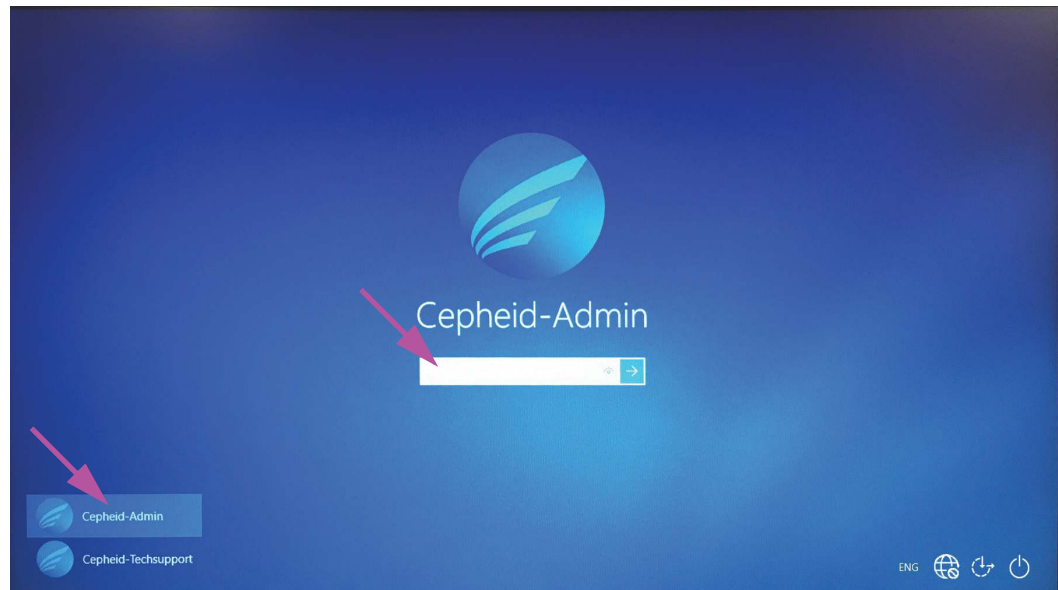

Figure 5-4. Windows 10 Account and Password Screen

4. On the Windows Password screen (see [Figure 5-3](#) and [Figure 5-4](#)), enter the password assigned by your system administrator.

Caution



Do not change the Cepheid user profile. Changing the profile can cause loss of data during a test.

5.2.3 Starting the Software

Note

Always turn on the instrument before starting the software.
Always end a software session before turning off the instrument.

The GeneXpert Dx software starts automatically after logging into Windows. If the GeneXpert Dx software is closed manually, the software can be started in one of two ways:

1. On the Windows desktop, double-click the GeneXpert Dx icon. See [Figure 5-5](#).

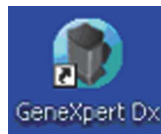

Figure 5-5. GeneXpert Dx System Shortcut Icon

or

On the Windows taskbar, click the Windows icon, and select **All Programs > Cepheid >GeneXpert Dx**.

2. The Login screen appears.

Each time the software is started, the Login dialog box appears and asks for a user name and password (see [Figure 5-6](#)). In the **User Name** box, type your GeneXpert Dx user name. In the **Password** box, type your password. Click **OK** to log on and start the software.

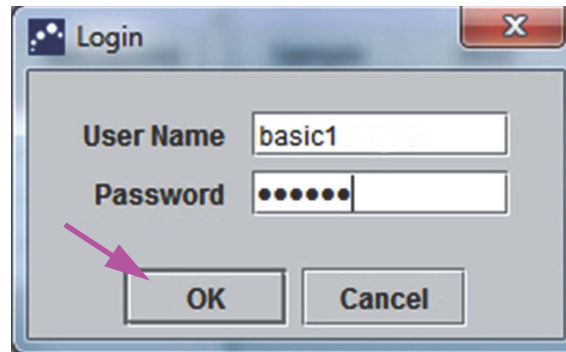

Figure 5-6. Login Dialog Box

The GeneXpert Dx System Window is displayed. See [Figure 5-7](#).

Note

The GeneXpert Dx software runs on Windows 7 and Windows 10. The screens shown in this manual are from GeneXpert Dx software running on Windows 7. Screens for GeneXpert Dx software running on Windows 10 will be similar.

Important

If the Login dialog box does not appear during the software startup, contact your GeneXpert Dx system administrator.

Note

If you forget your password, contact your GeneXpert Dx system administrator. If you are the GeneXpert Dx system administrator and you forget your password, contact Cepheid Technical Support. See the [Technical Assistance](#) section in the [Preface](#) for the contact information. Cepheid Technical Support will supply a temporary password to allow you to log on and change the password. The temporary password expires after 1 day.

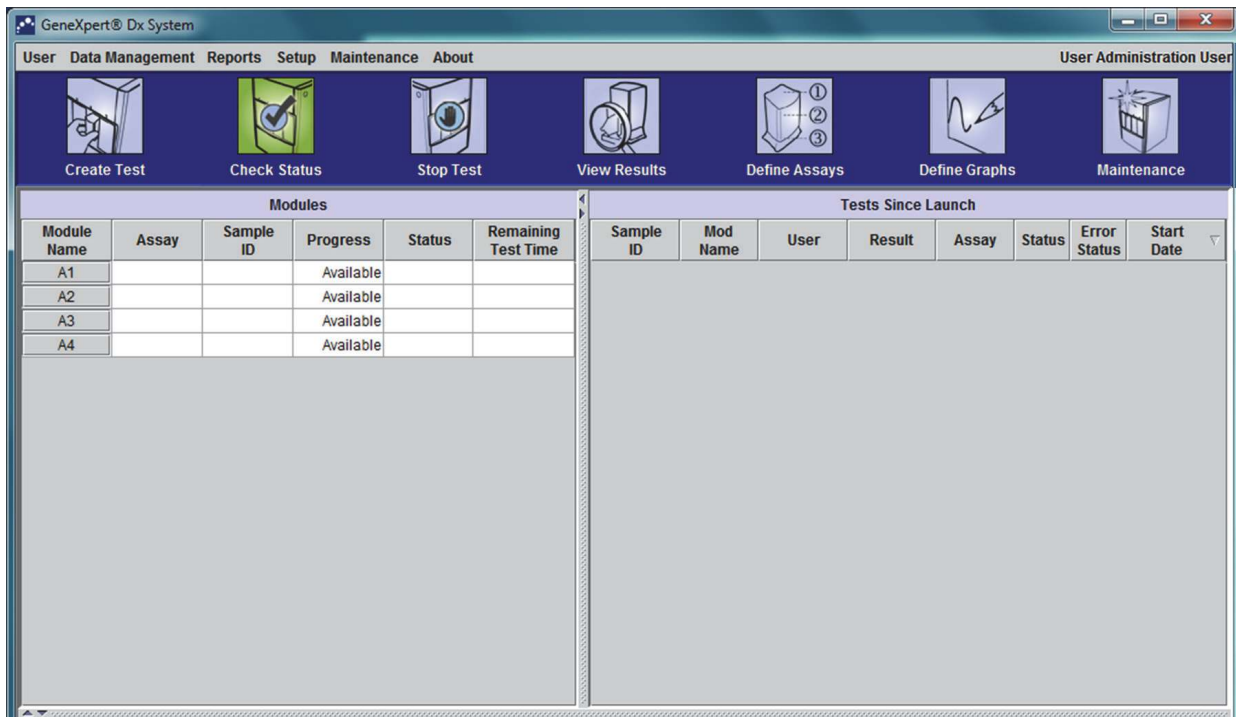

Figure 5-7. GeneXpert Dx System Window

Note

Most of the screens shown in this manual will be at a detail user login. Basic user login will be shown when needed to show screens relating to that specific user and administrator user login will be shown, where required.

5.2.3.1 Database Management Reminder

1. If the **Database Management Reminders** box on the System Configuration dialog box (see [Figure 2-76](#)) is **not** checked, the Database Management Dialog Box (see [Figure 5-8](#)) will not appear and no action concerning the database will be required. The software will continue to load and you can skip to [Section 5.2.3.2](#) to continue the startup sequence.
or
2. If the **Database Management Reminders** box on the System Configuration dialog screen (see [Figure 2-76](#)) is checked, the Database Management dialog box (see [Figure 5-8](#)) will then appear on top of the GeneXpert Dx System window asking if you want to perform Database Management tasks.

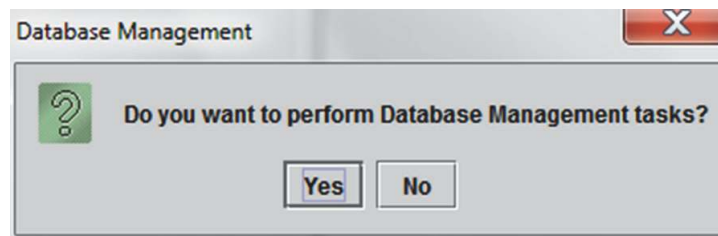

Figure 5-8. Database Management Dialog Box

- A. If you click **No** on the Database Management dialog box (see [Figure 5-8](#)). The GeneXpert Dx software continues to load and you can proceed to [Section 5.2.3.2](#).
or
- B. Click **Yes** in the Database Management dialog box (see [Figure 5-8](#)) and you will be asked to select the task to be performed (see [Figure 5-9](#)).

Note

Depending on the user's privileges, all (or any) of the four options in the Database Management dialog box may not be visible. See [Figure 5-9](#).

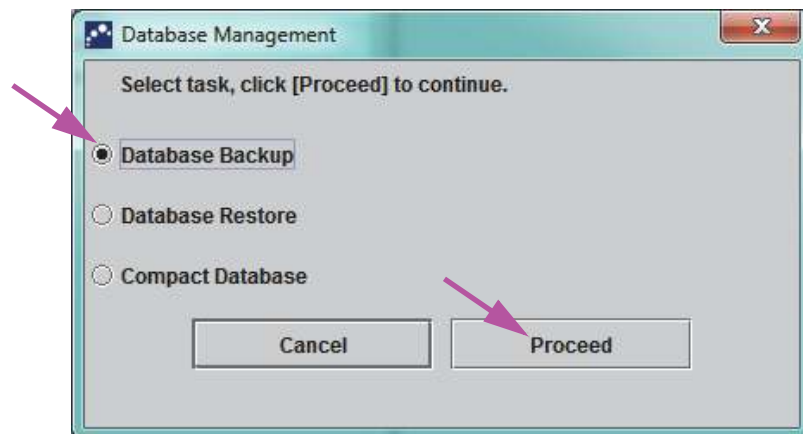

Figure 5-9. Database Management Dialog Box

3. Select the applicable button for the database management tasks desired (i.e., **Database Backup**, **Database Restore** or **Compact Database**).
See [Section 5.17, Performing Database Management Tasks](#) for details on how to perform each of the database management tasks.
4. Click the **Proceed** button (see [Figure 5-9](#)) to start performing the desired database management task.
5. When the database management task is complete, a confirmation dialog box appears. Click **OK**, and then the **Cancel** button in the Database Management dialog box.
The Database Management dialog box disappears from the GeneXpert Dx System window. Continue with [Section 5.2.3.2](#).

5.2.3.2 Archive Overdue Reminder

If an archive is not overdue, or if the archive setting in [Figure 2-76](#) is set to **Manually**, [Figure 5-10](#) will not appear, and you can skip directly to [Section 5.3](#).

If an archive is overdue, the Test Archive Reminder dialog box will appear (see [Figure 5-10](#)).

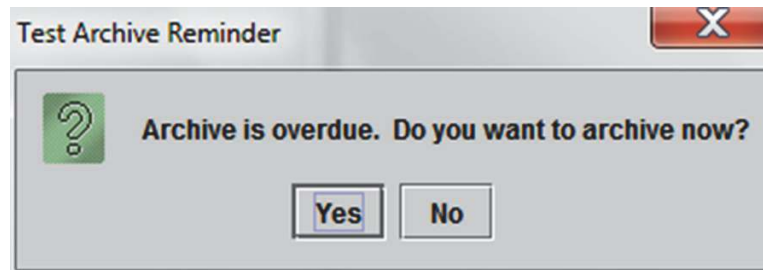

Figure 5-10. Test Archive Reminder Dialog Box

If you do not want to archive, click **No** in the Test Archive Reminder dialog box (see [Figure 5-10](#)). Continue the startup sequence without archiving, in [Section 5.3](#).

or

If you would like to archive, click **Yes** in the Test Archive Reminder dialog box (see [Figure 5-10](#)) to continue the startup sequence with archiving. The Select Test(s) To Be Archived screen appears. See [Figure 5-11](#).

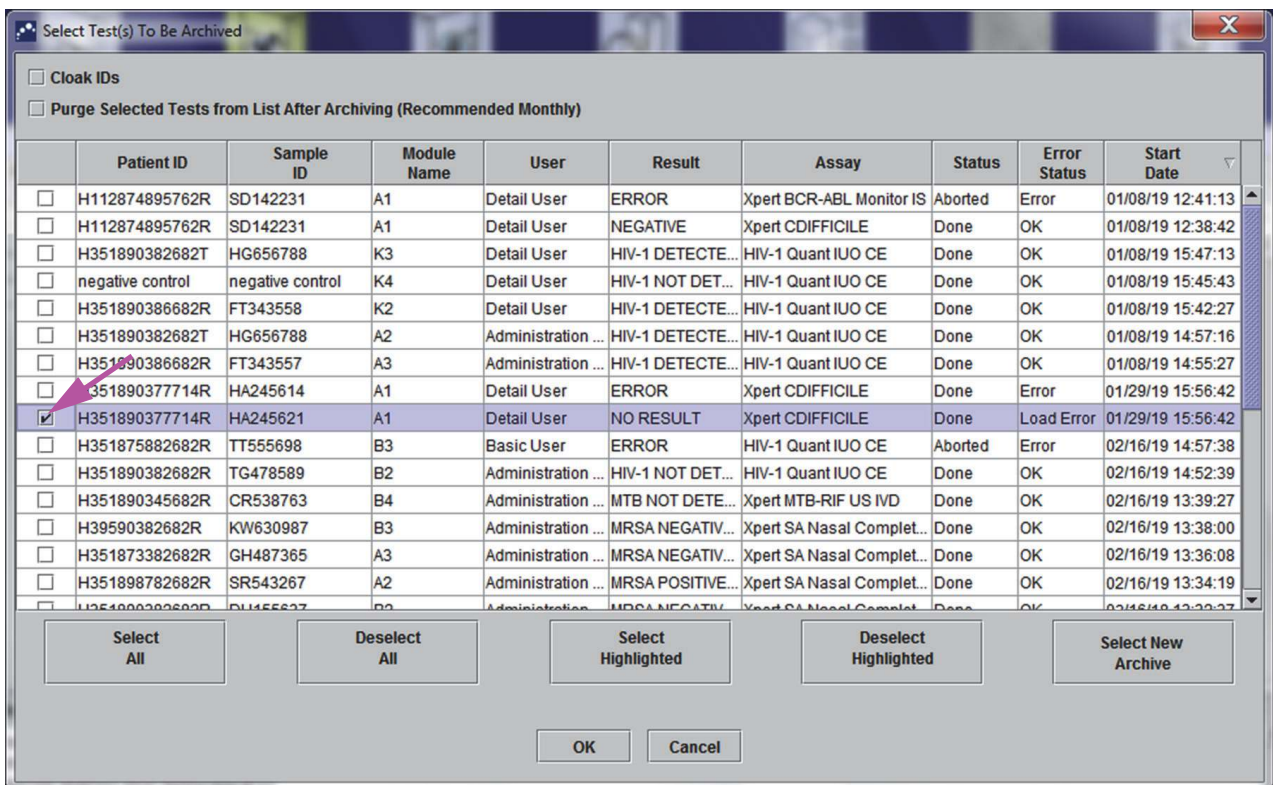

Figure 5-11. Select Test(s) To Be Archived Screen

To archive tests, perform [Step 2](#) through [Step 7](#) of the procedure in [Section 5.16.1, Archiving the Tests](#). When you are finished with the archiving, continue with [Section 5.3](#).

5.2.4 Logging On with Software Running

If another user is logged onto the system, it is not necessary to log the other user out before logging in. To log on to the software while the software is running: on the **User** menu, click **Login**. See [Figure 5-12](#).

Enter your information into the Login dialog box (see [Figure 5-6](#)). You will be logged onto the system and the other use will be automatically logged out.

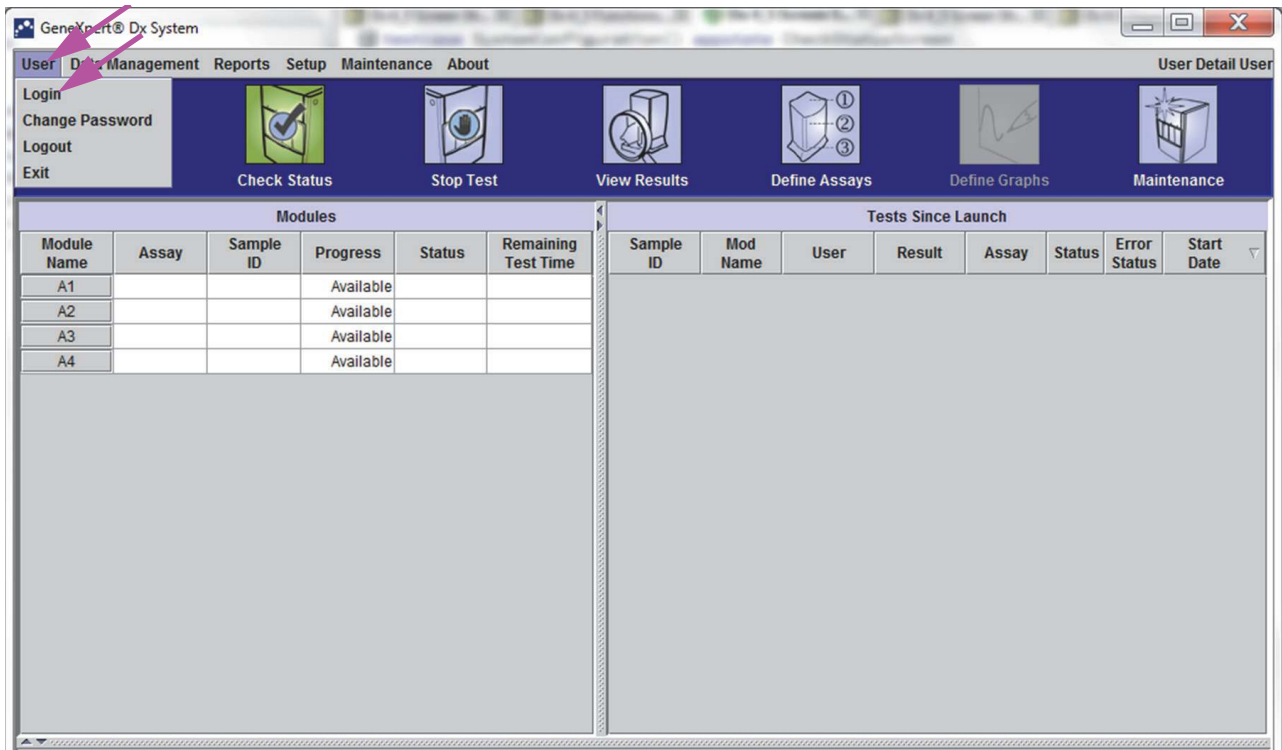

Figure 5-12. User Menu (Login)

5.2.5 Logging Off

To log off the software: in the GeneXpert Dx System window, on the **User** menu, click **Logout**. See Figure 5-13.

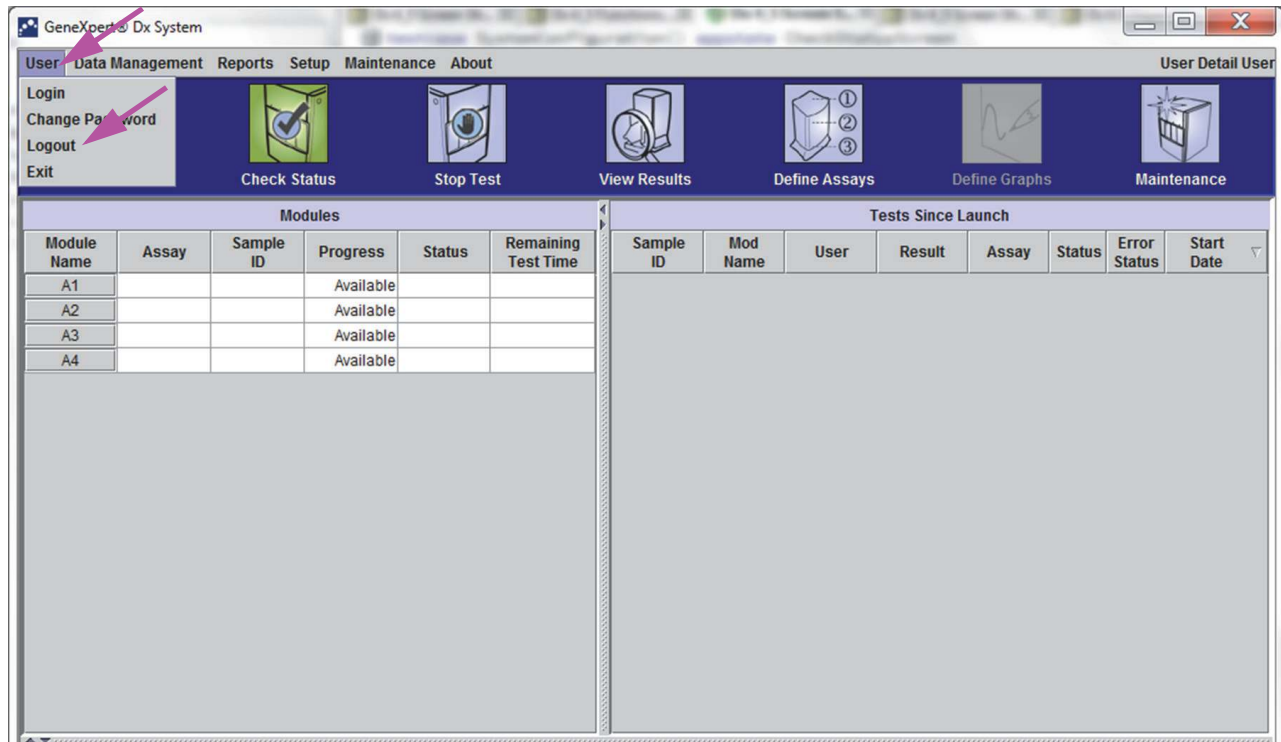

Figure 5-13. User Menu (Logout)

The GeneXpert Dx System window displays **User Logged Out**. You should log off if you are going to be away from the system for an extended period of time. Logging off prevents the software from recording other users' activities under your account.

Note

If you log out while a test is in progress, the system will finish the test and save the results.

5.2.6 Changing Your Password

Important In order to maintain system security, users should change their password every 90 days.

Cepheid recommends that users change their password every 90 days to protect their identity on the GeneXpert Dx system. Your institution may have additional requirements for changing passwords. Follow your institution’s policies regarding passwords. To change your GeneXpert Dx software password:

1. In the GeneXpert Dx System window, on the **User** menu, click **Change Password**. See Figure 5-14. The Change Password dialog box is displayed (see Figure 5-15).

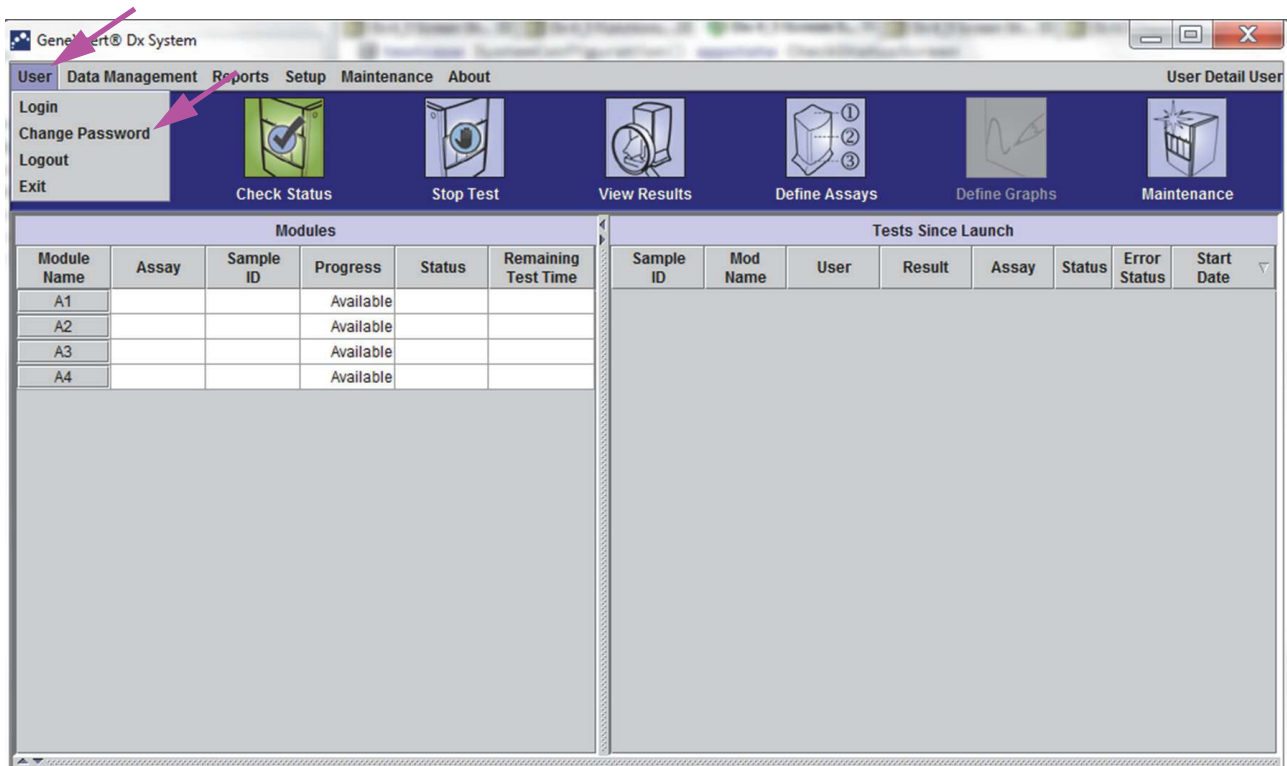

Figure 5-14. User Menu (Change Password)

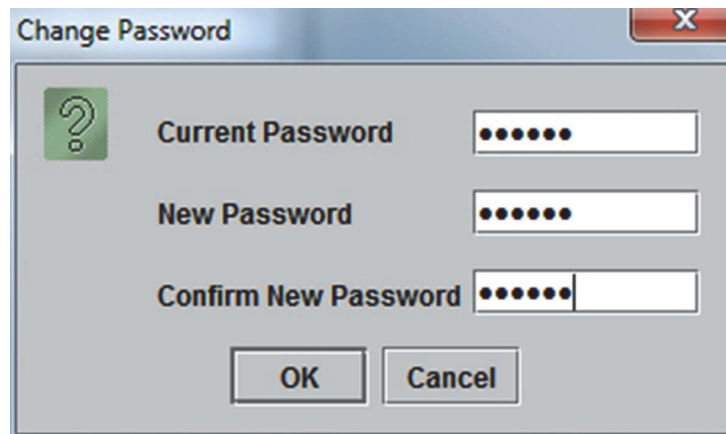

Figure 5-15. Change Password Dialog Box

2. In the **Current Password** box, type your current password.
3. In the **New Password** and **Confirm New Password** boxes, type your new password (must be 6 to 10 characters).
4. Click **OK** to save the change.
5. A dialog box will be displayed indicating that the password was successfully changed. Click **OK** to close the dialog box.

If the password does not meet the minimum requirements, a dialog box will be displayed indicating the requirements. Click **OK** to return to the Change Password dialog box and close the dialog box.

5.3 Using the System Window

When you start the GeneXpert Dx software, the GeneXpert Dx System window appears. Figure 5-16 shows an example of the GeneXpert Dx System window.

Depending on the permissions you have, the window in Figure 5-16 might vary slightly. For information about your user profile and permissions, see your GeneXpert Dx system administrator.

When you click **Check Status**, **View Results**, **Define Assays**, or **Maintenance** on the menu bar, the window contents change and a new menu appears on the menu bar. For example, if you click **View Results**, the View Results window displaces the current window contents. In addition, the View Results menu appears on the menu bar so that you have the option of accessing the View Results functions from the menu.

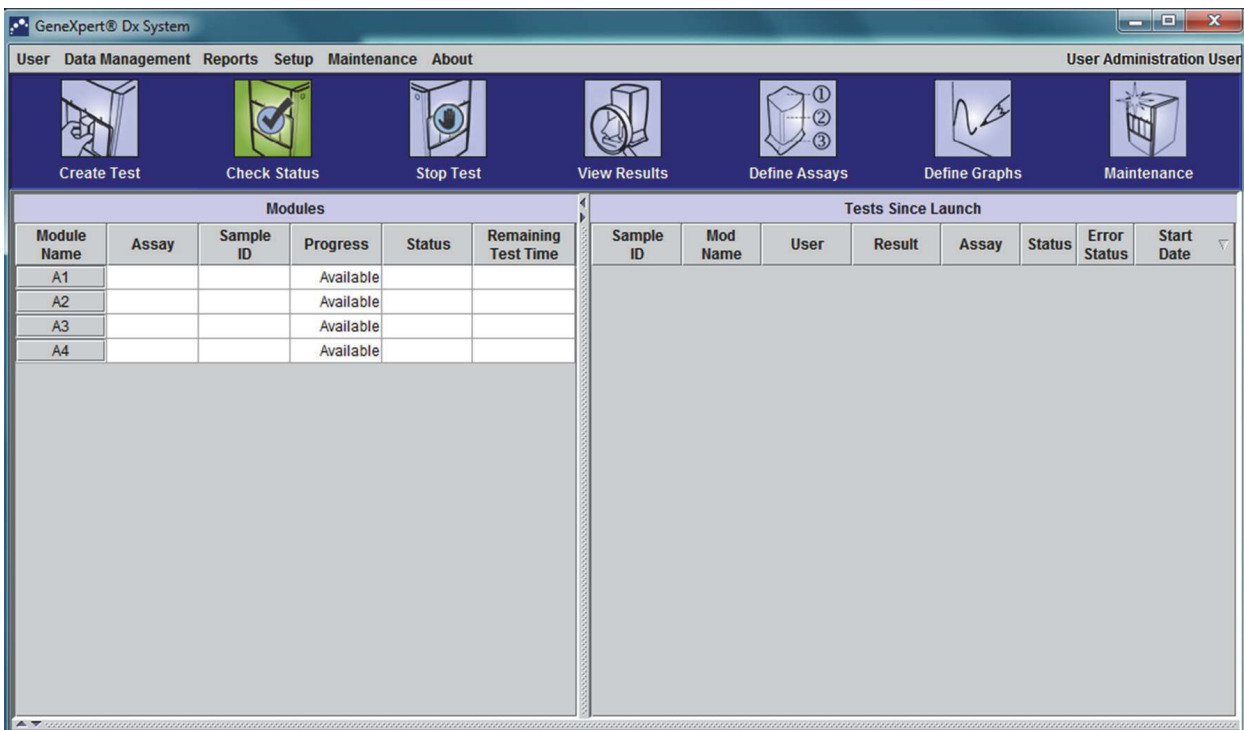

Figure 5-16. GeneXpert Dx System Window

5.4 Checking the List of Available Assay Definitions

Before starting an *in vitro* diagnostic test, check that the assay definition you want to use is already loaded into the software. To do this:

1. In the GeneXpert Dx System window, click **Define Assays**. The Define Assays window appears (see [Figure 5-17](#)).
2. In the **Assay** list (on the left side of the window), verify that the assay definition you want to use is present. Cartridges will not run with an assay version that does not match the cartridge barcode information. Make sure to use the latest version of the assay definition file.
3. If the assay is not listed, import the assay definition file. See [Section 2.16.2, Importing Assay Definitions](#). You must have permission to import assay definitions. If you do not have such permission, contact your GeneXpert Dx system administrator.

List of Available Assays

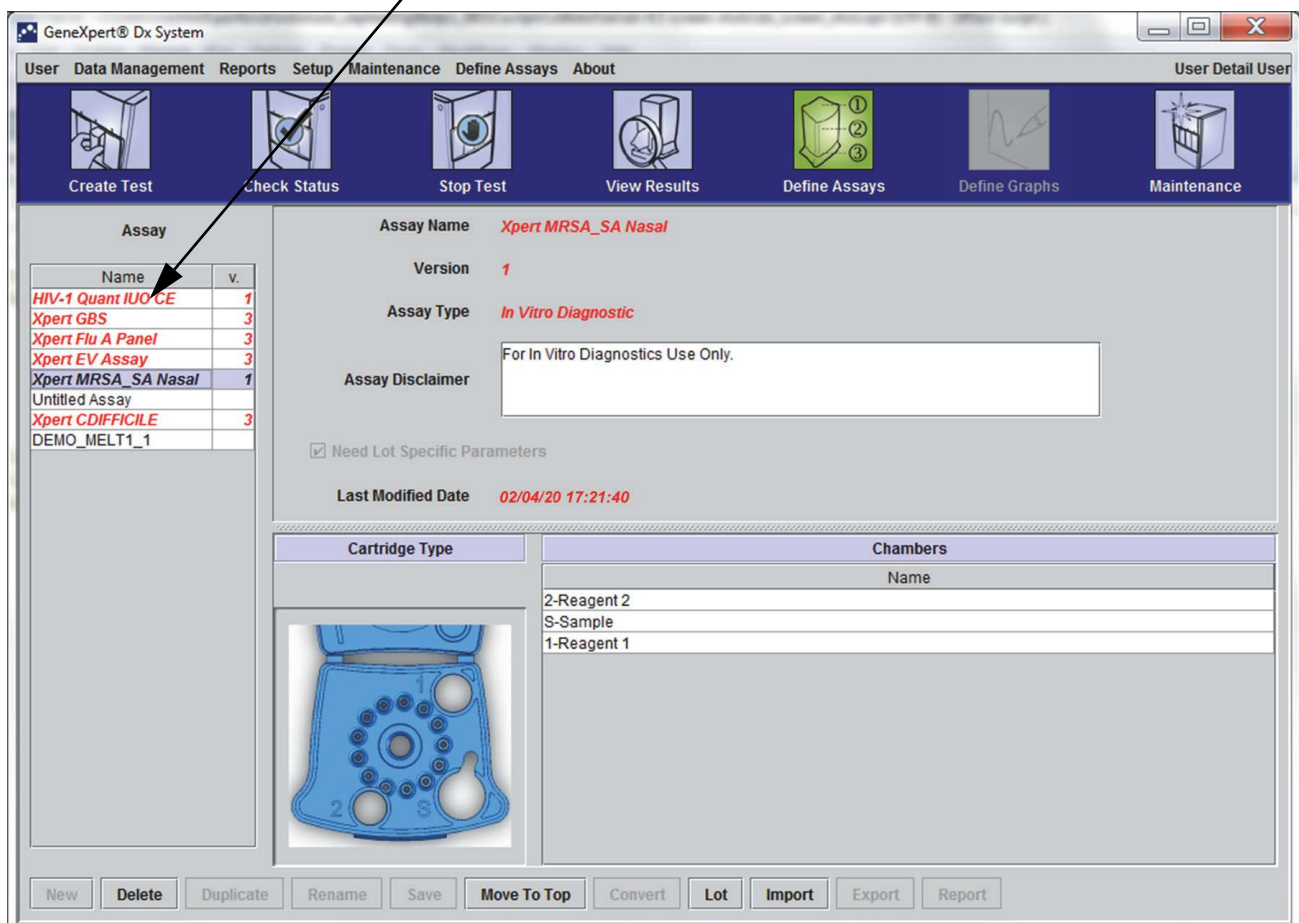

Figure 5-17. GeneXpert Dx System—Define Assays Window

5.5 Barcode Scanner Usage

Note

Using the hand-held scanner is similar for all scanning operations, such as scanning the Patient ID, the Sample ID and the cartridge barcode, although this section describes the scanning of the cartridge barcode. See [Figure 5-18](#).

To scan a cartridge barcode, follow the instructions in this section.

1. Scan the barcode by holding the scanner about 8 to 10 inches from the barcode, aligning the laser on the scanner to the barcode image. [Figure 5-18](#) shows a cartridge barcode being scanned.
2. When aiming is correct, press the trigger control on the scanner. An audible beep will sound.

Note

If the barcode on the cartridge is damaged or smudged and cannot be scanned, skip the cartridge and contact Cepheid Technical Support for a replacement cartridge, if necessary. If the barcode scanner is damaged, missing or incorrectly configured, contact Cepheid Technical Support.

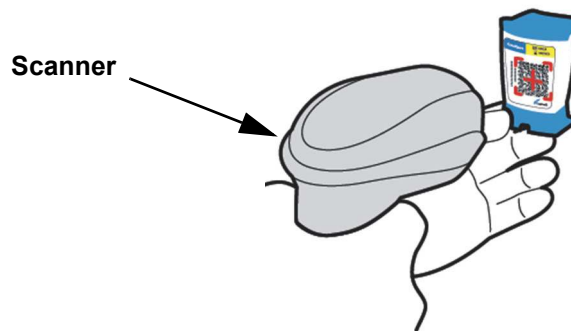

Figure 5-18. Scanning a Cartridge Barcode

5.6 Creating a Test

Caution



The information you provide in the **Create Test** dialog box is automatically saved when you start the test. If you close the **Create Test** dialog box before you start the test, all information will be lost.

Note

For screenshots shown in this manual, the **Patient ID** field will be shown as enabled and the **Patient ID 2** and **Patient Name** fields will also be enabled. The **Patient ID**, **Patient ID 2** and **Patient Name** fields are optional and may be left blank if they are not required. If these options are not enabled in the system configuration screen, they will not be displayed. In addition, **Patient Demographics** will be displayed only if enabled by your GeneXpert Dx system administrator (see [Section 2.14, Configuring the System](#)).

Scanning the Patient ID, Sample ID, and cartridge label reduces typing errors and helps ensure that the Patient ID, Sample ID, and test results are properly linked. If the barcode scanning options are not turned on, the Patient ID, Sample ID, and assay information can be provided manually.

Important

The following symbols cannot be used for **Sample ID**, **Patient ID**, **Patient ID2**, **First Name**, **Last Name**, **Other Sample Type**, or **Notes**: | @ ^ ~ \ & / : * ? " < > ' \$ % ! ; () -

When a test is being created, a record of how a specimen is processed is being created. The record includes **Patient ID**, **Sample ID**, cartridge information, the assay information, instrument module ID, and test type. In addition, **Patient ID 2**, **First Name**, **Last Name**, and **Patient Demographic** information is also included, if enabled (checked) in the system configuration.

Note

Patient Demographic data cannot be edited after data entry.

Note

For screens shown in this example, **Patient ID 2**, **First Name**, **Last Name** and **Patient Demographics** are enabled. If some of these options are not enabled, screens will vary in appearance.

To create a test:

1. In the GeneXpert Dx System window, click **Create Test** on the menu bar. The Scan Patient ID Barcode dialog box appears. See [Figure 5-19](#).
2. Scan the Patient ID barcode using the supplied barcode scanner. See [Section 5.5](#). The Scan Sample ID dialog box appears. See [Figure 5-20](#).

To enter the Patient ID barcode manually, click the **Manual Entry** button. The Manual Patient ID Barcode Entry dialog box will be displayed. Enter the patient ID barcode into the **Patient ID Barcode** field and click **OK**.

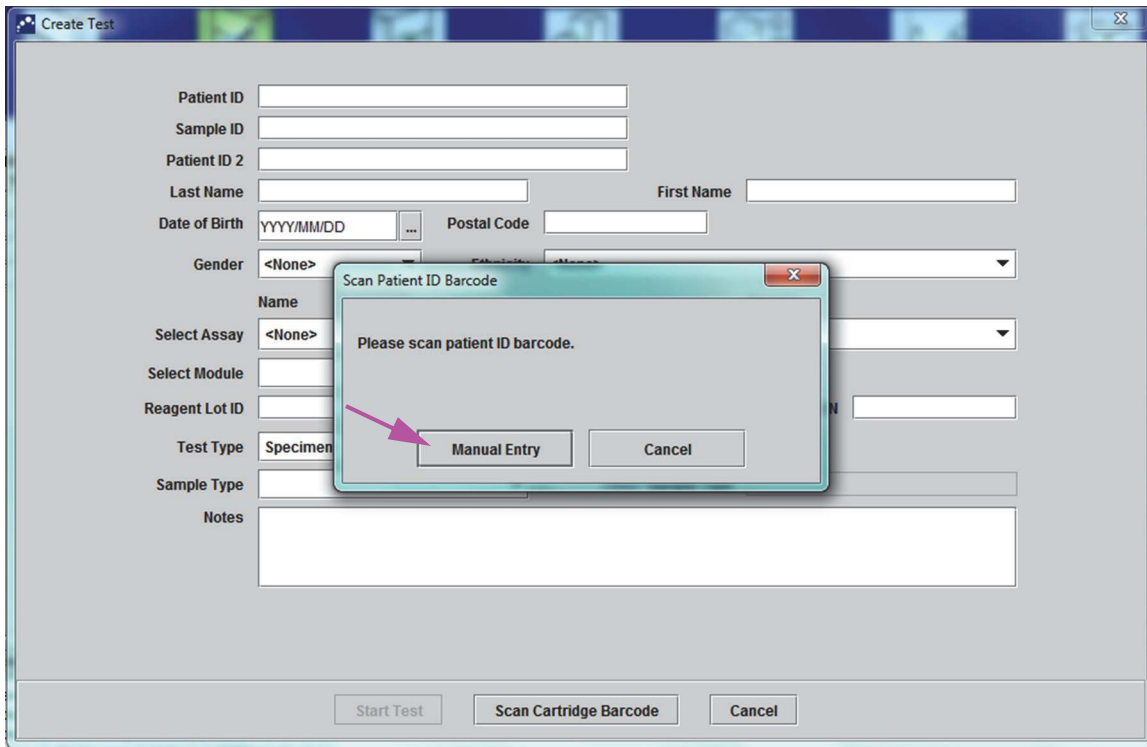

Figure 5-19. Create Test Window and Scan Patient ID Barcode Dialog Box

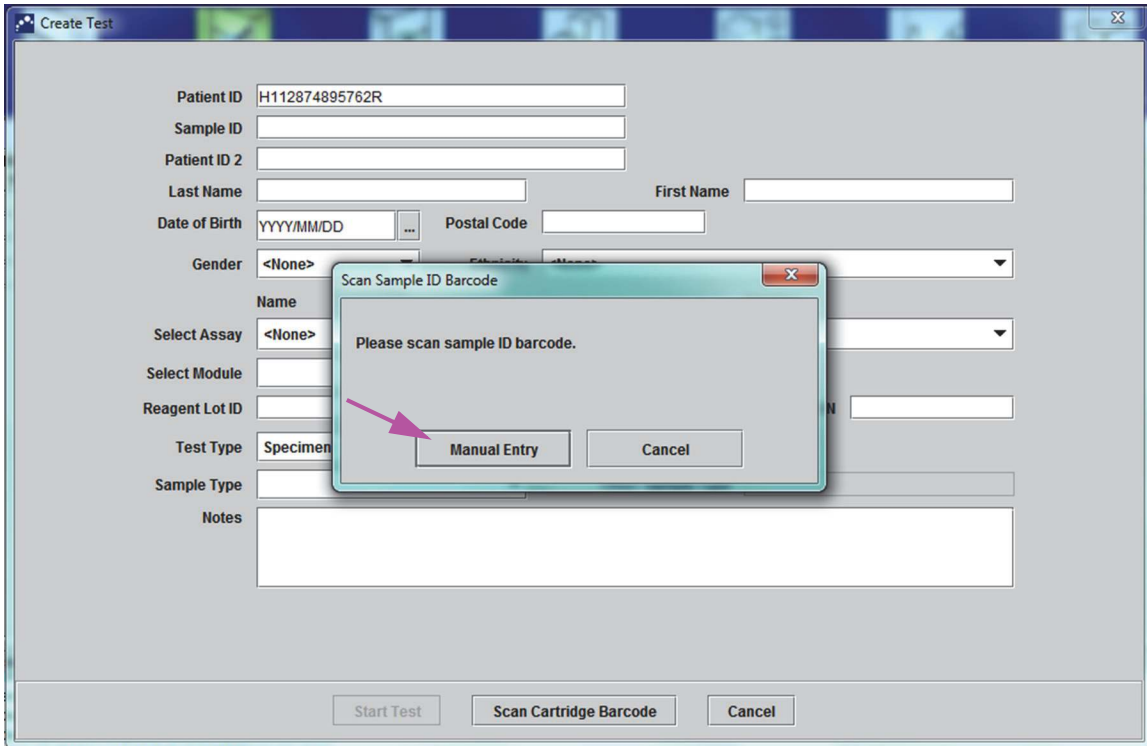

Figure 5-20. Create Test Window and Scan Sample ID Barcode Dialog Box

3. Scan the Sample ID barcode using the supplied barcode scanner. See [Section 5.5](#). The Scan Cartridge Barcode dialog box appears. See [Figure 5-21](#).

To enter the Sample ID barcode manually, click the **Manual Entry** button. The Manual Sample ID Barcode Entry dialog box will be displayed. Enter the sample ID barcode into the **Sample ID Barcode** field and click **OK**.

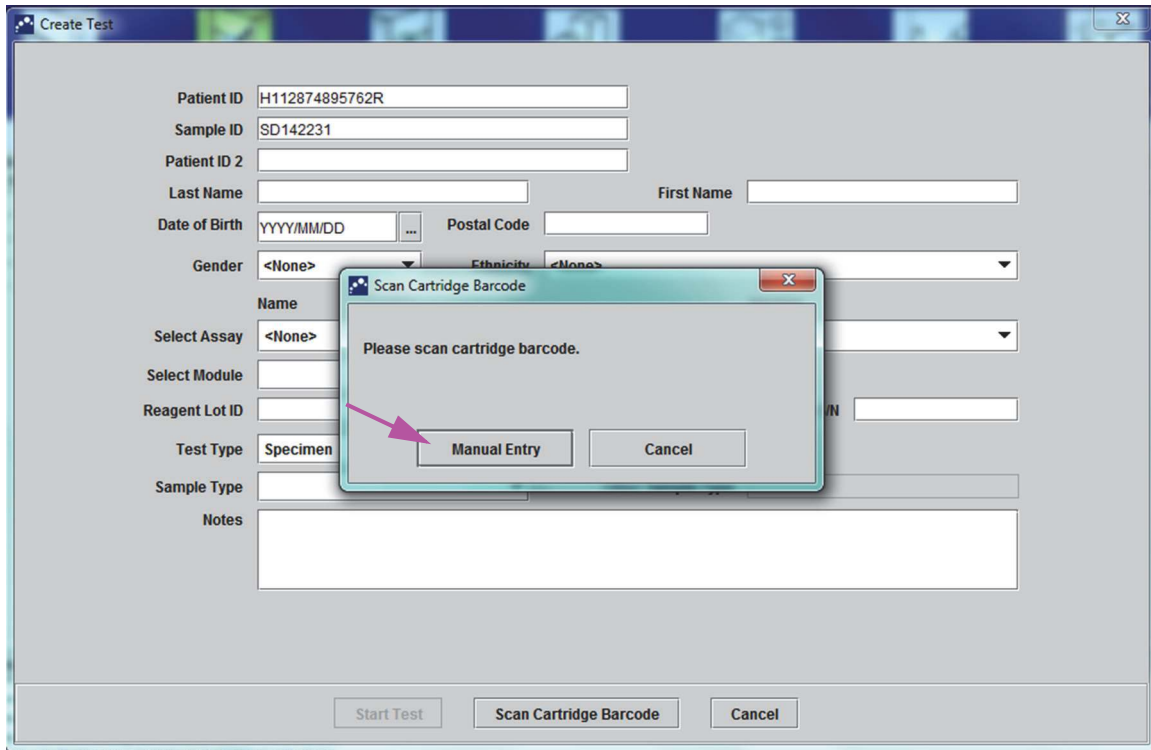

Figure 5-21. Scan Cartridge Barcode Dialog Box

4. Scan the cartridge barcode using the supplied barcode scanner. See [Section 5.5](#). The Create Test dialog box appears as shown in [Figure 5-23](#). Note that the software automatically fills the required information into the Create Test window.

To enter the cartridge barcode manually, click the **Manual Entry** button. The Manual Cartridge Barcode Entry dialog box will be displayed. Enter the cartridge barcode into the **Cartridge Barcode** field and click **OK**.

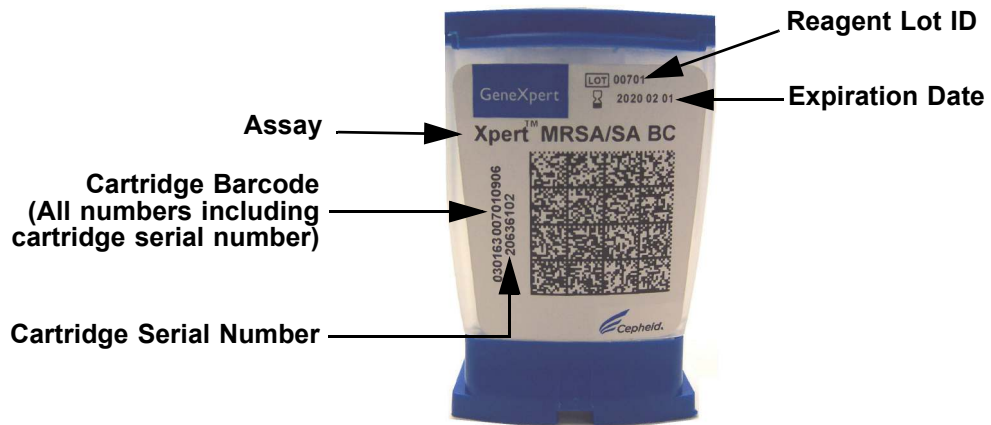

Figure 5-22. GeneXpert Cartridge

Important

Type in the cartridge information accurately. This information will appear on all patient and results reports.

Important

To ensure the accuracy of test results, be sure to use the same cartridge in the test. (Do not switch or substitute cartridges after scanning and other preparations have begun.)

Important

If you see multiple assays in the drop-down menu, select the desired assay.

5. (Optional) If **Patient ID 2** is enabled, place the cursor in the field. The **Patient ID 2** can be either scanned or entered manually into the field.
6. (Optional) If **Patient Name** is enabled, place the cursor in the **Last Name** field and enter the patient's last name then place the cursor in the **First Name** field and enter the patient's first name (see [Figure 5-23](#)).

The screenshot shows a 'Create Test' dialog box with the following fields and values:

- Patient ID: H112874895762R
- Sample: SD142231
- Patient ID 2: 1234567
- Last Name: Patient Last Name 1
- First Name: Patient First Name 1
- Date of Birth: YYYY/MM/DD
- Postal Code:
- Gender: <None>
- Ethnicity: <None>
- Select Assay: Xpert-C. difficile G2
- Version: 2
- Select Module: A2
- Reagent Lot ID*: 08100
- Expiration Date*: 2020/12/25
- Cartridge S/N*: 70462806
- Test Type: Specimen
- Sample Type: Other
- Other Sample Type:
- Notes:

Buttons at the bottom: Start Test, Scan Cartridge Barcode, Cancel.

Figure 5-23. Create Test Dialog Box with the Patient ID and Sample ID Fields Shown

7. (Optional) If **Patient Demographics** is enabled, follow the steps below to enter the desired data:
 - A. **Date of Birth**—Click the drop-down arrow in the **Date of Birth** box to display the calendar.
Using the <<**Previous** and **Next**>> buttons, scroll through the calendar to display the appropriate year and month. Select the patient’s birth date and click **OK** (see [Figure 5-24](#)).

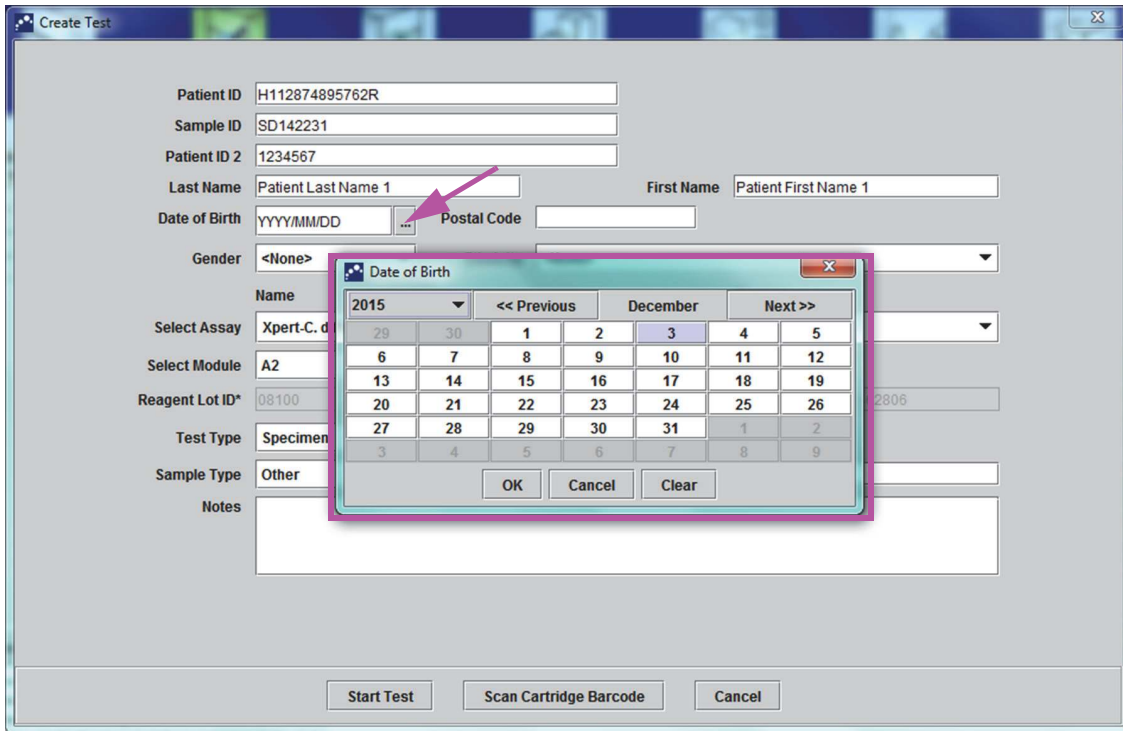

Figure 5-24. Create Test Dialog Box with the Date of Birth Field and Calendar Shown

- B. **Ethnicity**—Click the drop-down arrow in the **Ethnicity** box and select the appropriate ethnicity from the drop-down menu (see Figure 5-25).

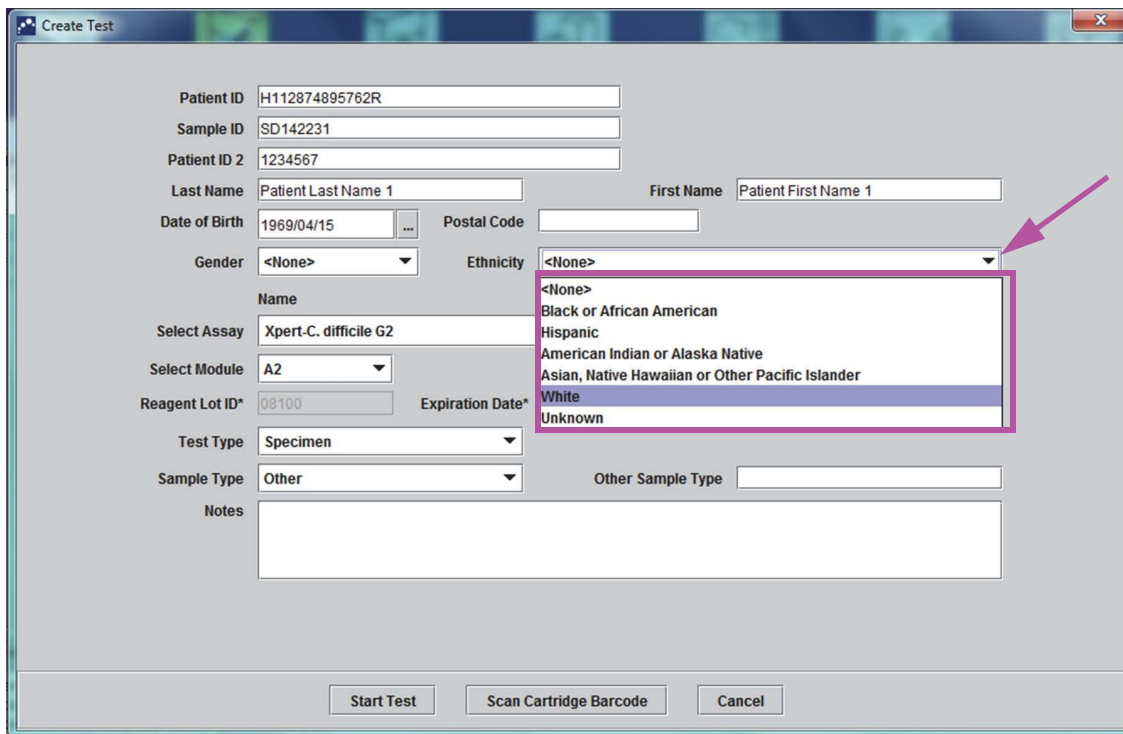

Figure 5-25. Create Test Dialog Box with the Ethnicity Field Shown

- C. **Gender**—Click the drop-down arrow in the **Gender** box and select the appropriate gender from the drop-down menu that appears (see Figure 5-26).

Figure 5-26. Create Test Dialog Box with the Gender Field Shown

- D. **Postal Code**—Type the postal code (the entry may be left blank). The GeneXpert Dx software does not validate the postal code. In the United States, the postal code is referred to as the zip code.
8. (Optional) In the **Select Module** list, select the available instrument module. By default, the software displays the module that is least used. Only modules with the correct calibration and that are not busy running another test will be selectable. You can change the selected module by clicking on the drop down menu.
9. Select the **Test Type (Specimen or External Controls)**.
10. Type any additional information about the test in the **Notes** box.

Note

The Cepheid barcode scanner has been qualified to be used with Codabar, Code 39, Code 128a, Code 128b, Code 128c or interleaved 2 of 5 barcode symbologies.

Caution



For customers planning to use the interleaved 2 of 5 symbology, note that due to the construction of the interleaved 2 of 5 symbology, it is possible for a scan line covering only a portion of the code to be interpreted as a complete scan, yielding less data than is encoded in the bar code. To prevent this, select specific lengths (interleaved 2 of 5—One Discrete Length) for interleaved 2 of 5 applications. For assistance, call Cepheid Technical Support. See the [Technical Assistance](#) section in the [Preface](#) for the contact information.

Caution



Make sure you scan or type the correct Sample ID, Patient ID, or Patient ID 2. The Sample ID, Patient ID, or Patient ID 2 is associated with the test results and is shown in the View Results window and all the reports.

The following symbols cannot be used for Sample ID, Patient ID, or Patient ID2: | @ ^ ~ \ & / : * ? " < > ' \$ % ! ; () -

5.7 Loading a Cartridge into an Instrument Module

Caution



Do not load a GeneXpert cartridge that has been dropped or shaken after the lid of the cartridge has been opened. Dropping or shaking the cartridge after it has been opened can cause invalid results. Bent or broken reaction tubes can also produce invalid results. Do not re-use spent cartridges.

Caution



Always pick up the cartridge by its body. Do not pick up the cartridge by the protruding reaction tube (see [Figure 5-27](#)).



Figure 5-27. Cartridge Showing Body and Reaction Tube

This section assumes that you have inserted the specimen and reagents into the GeneXpert cartridge. See the assay-specific package insert or quality-control labeling document for instructions.

5.8 Starting the Test

Caution



Do not run other software while a test is in progress. Doing so might interfere with the test process and cause the loss of data.

Note

If you log out while a test is in progress, the system will continue to finish the test and save the results.

To start the test:

1. In the Create Test dialog box (see [Figure 5-28](#)), click **Start Test**. The software asks for your password (if a password is required to start a test).

Note

If your user name is not displayed, type both your user name and password.

The screenshot shows the 'Create Test' dialog box with the following fields and values:

- Patient ID: H112874895762R
- Sample ID: SD142231
- Patient ID 2: 1234567
- Last Name: Patient Last Name 1
- First Name: Patient First Name 1
- Date of Birth: 1969/04/15
- Postal Code: 10001
- Gender: Male
- Ethnicity: White
- Select Assay: Xpert-C. difficile G2
- Version: 2
- Select Module: A2
- Reagent Lot ID*: 08100
- Expiration Date*: 2020/12/25
- Cartridge S/N*: 70462806
- Test Type: Specimen
- Sample Type: Other
- Other Sample Type: (empty)
- Notes: (empty text area)

At the bottom, there are three buttons: 'Start Test' (highlighted with a pink arrow), 'Scan Cartridge Barcode', and 'Cancel'.

Figure 5-28. Create Test Dialog Box, Ready to Start Test

2. Type your password, and then click **OK**. In the Check Status window, the instrument module progress changes to **Waiting**. The green light above the instrument module door flashes.
3. Open the instrument module door below the module with the flashing green light.

4. Place the cartridge on the module bay floor. See [Figure 5-29](#). The cartridge label should face out. Make sure the cartridge sits level on the bay floor and is positioned at the heel of the bay.
5. Close the instrument module door all the way. The door latches and the green light stops flashing and stays on. The test starts.



Figure 5-29. GeneXpert Cartridge, Positioned at the Heel of the Module Bay Floor

During the first few minutes after you start the test, the system moves the cartridge contents and rehydrates the reagent beads. The system also performs a probe check to determine if the reagent material is reconstituted properly and that the probes are present in the reagent material.

- If the probe check fails, the test will abort. You can check the error message to review the cause of the probe check failure. See [Section 9.19.2, Error Messages](#).
- If the probe check passes, the test continues.

When the test finishes, the instrument module door unlatches and the green light turns off. In the GeneXpert Dx System window, the **Progress** column in the **Modules** area shows the module is available.

5.9 Monitoring the Test Process

You can monitor the test process or other status indicators in the following areas of the GeneXpert Dx System window. See [Figure 5-30](#):

- **Modules**—Displays the assay definition used, the Sample ID, the progress or phase of the test (for example, 3/45 means the test is on the third PCR cycle out of 45 cycles), the status of the test phase, and the amount of time remaining until the end of the test. If the **Status** column displays **Error** or **Warning**, look in the **Messages** area of the window for a description of the problem.
- **Messages**—Displays the date and time you started the software, the software version number, and any error messages that were encountered since the software started.

Check the Module Area for Test Status

The screenshot displays the GeneXpert Dx System interface. At the top, there is a menu bar with options: User, Data Management, Reports, Setup, Maintenance, About. Below the menu is a toolbar with icons for 'Create Test', 'Check Status', 'Stop Test', 'View Results', 'Define Assays', 'Define Graphs', and 'Maintenance'. The main window is divided into two primary sections: 'Modules' and 'Tests Since Launch'.
Modules Table:

Module Name	Assay	Sample ID	Progress	Status	Remaining Test Time
A1	Xpert CDIF...	SD142231	Loading	OK	--:--
A2			Available		
A3			Available		
A4			Available		

Tests Since Launch Table:

Sample ID	Mod Name	User	Result	Assay	Status	Error Status	Start Date
SD142231	A1	Detail User	NO RESULT	Xpert CDI...	Loadi...	OK	02/09/20 12:...

Messages:

```

Module A1: Performing Self-Test at 02/09/20 12:32:53
Module A2: Performing Self-Test at 02/09/20 12:32:54
Module A3: Performing Self-Test at 02/09/20 12:32:55
Module A4: Performing Self-Test at 02/09/20 12:32:55
Please load the cartridge into the module A1.

```

Figure 5-30. GeneXpert Dx System Window, Displaying the Status of a Run in Progress

When a test is in progress, **NO RESULT** is shown in the **Result** column.

Note

The right side of the screen, **Tests Since Launch**, displays tests since the most current launch of the GeneXpert Dx software.

5.10 Stopping a Test in Progress

Caution



After you stop a test in progress, the system halts the sample processing activities and terminates data collection. The cartridge cannot be reused.

To stop a test that is currently in progress, in the GeneXpert Dx System window, click **Stop Test** on the menu bar. The Stop Test dialog box appears. See [Figure 5-31](#). You can do one of the following:

- **Stop Individual Tests**—Select the tests you want to stop, and then click **Stop**. The confirmation dialog box appears. Click **Yes** to confirm or click **No** to cancel.
- **Stop All Tests in Progress**—Click **Select Running** to select all tests currently in progress, and then click **Stop**. The confirmation dialog box appears. Click **Yes** to confirm or click **No** to cancel.
- To clear all of the test selections, click **Deselect All**.
- Click **Cancel** to close the Stop Test dialog box.

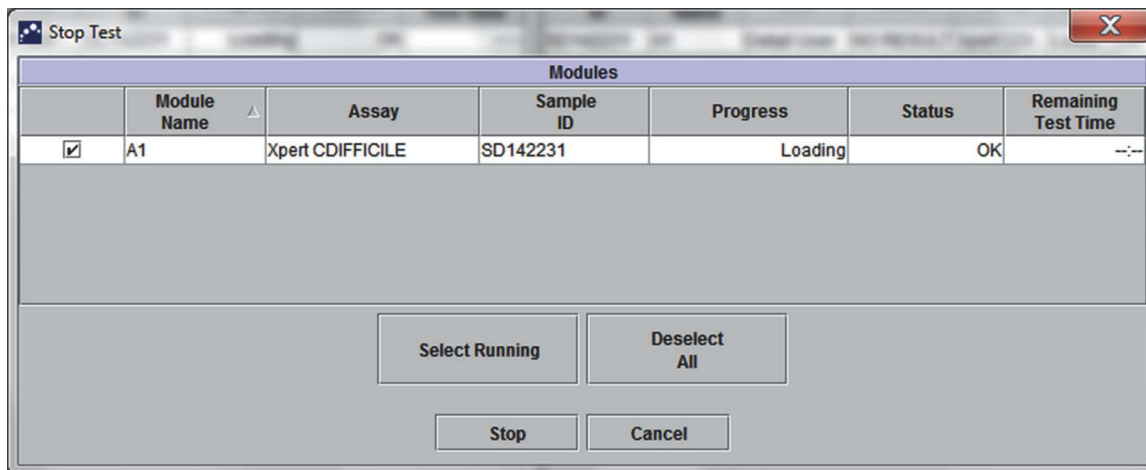

Figure 5-31. Stop Test Dialog Box

5.11 Viewing the Test Results

Important

To ensure all data is displayed correctly, reports must be generated in the same language that was used when the test results were collected.

You can display and view the test results in the View Results window. See [Section 5.11.1, Displaying the Test Results](#). The features in the View Results window vary by user type:

- Basic users (see [Section 5.11.2, Basic User View](#))
- Detail users and the administrator (see [Section 5.11.3, Detail User and Administrator View](#))

5.11.1 Displaying the Test Results

To select and display the test results:

1. In the GeneXpert Dx System window, click **View Results** on the menu bar. The View Results window appears. See [Figure 5-32](#).

Note

The View Results window displays different features for different user types. [Section 5.11.2, Basic User View](#) describes the View Results window for the Basic users. [Section 5.11.3, Detail User and Administrator View](#) describes the View Results window for the Detail users and Administrator users. [Figure 5-32](#) shows a View Results window for Detail users and Administrator users.

To select a test, click **View Test**. The Select Test To Be Viewed dialog box appears. See [Figure 5-33](#).

2. Select the test to be viewed. To sort the list of tests by a column, click the column heading.
3. Click **OK**. The results of the selected test is displayed in the View Results window.

Important

Sometimes only part of the result information is shown in the **Result** column of the **Select Test to be Viewed** dialog box. To see the rest of the result information, move the mouse's cursor over the **Result** column.

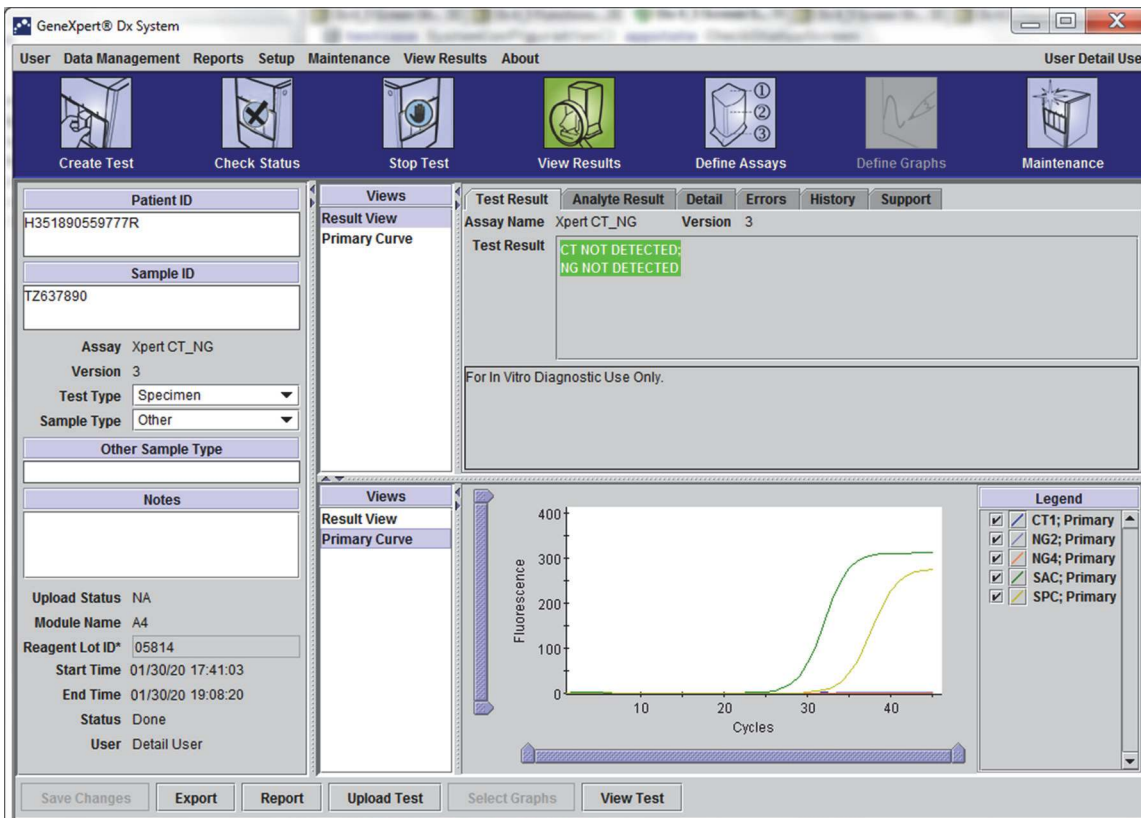

Figure 5-32. GeneXpert Dx View Results Window (Detail and Administrator View)

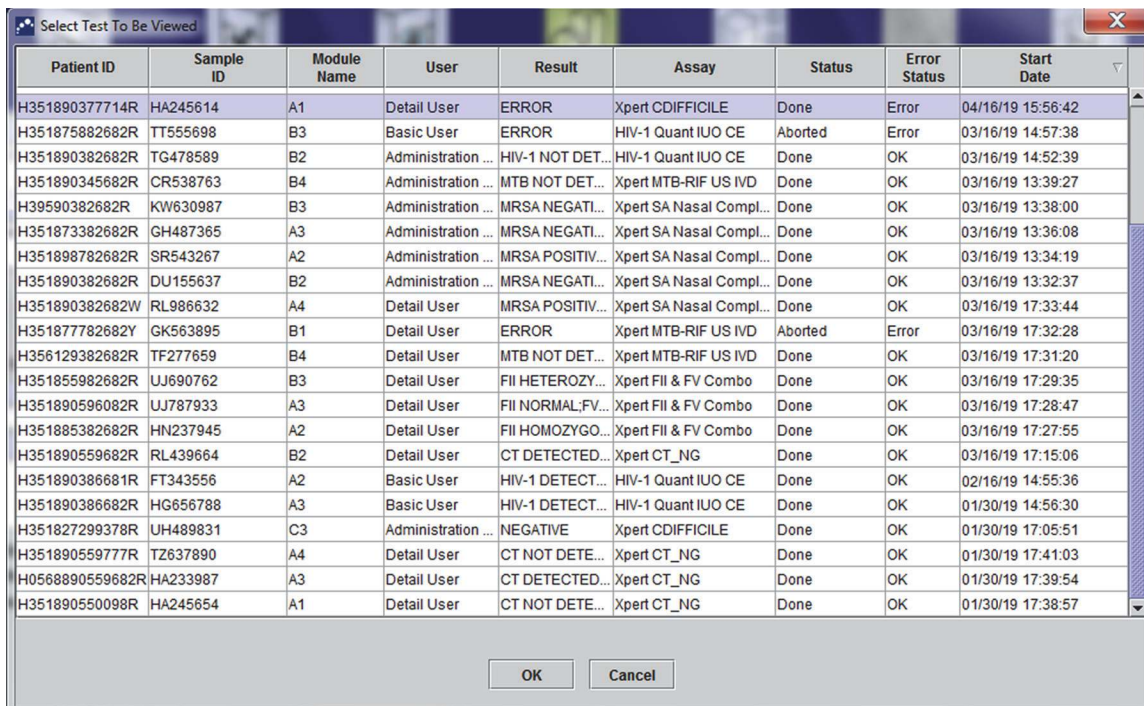

Figure 5-33. Select Test to be Viewed Dialog Box

5.11.2 Basic User View

Figure 5-34 shows the View Results window for Basic users. The window contains three tabs: **Results**, **Errors**, and **Support**.

5.11.2.1 Results Tab

The **Results** tab displays the following information for a test (see Figure 5-34):

The screenshot shows the GeneXpert Dx System interface. The title bar reads "GeneXpert® Dx System". The menu bar includes "User", "Data Management", "Reports", "Setup", "Maintenance", "View Results", and "About". The user is identified as "User Basic User". The toolbar contains icons for "Create Test", "Check Status", "Stop Test", "View Results" (highlighted with a pink arrow), "Define Assays", "Define Graphs", and "Maintenance".

The "Results" tab is active, showing the following fields:

- Patient ID:** H351890550098R
- Sample ID:** HA245654
- Assay:** Xpert CT_NG
- Version:** 3
- Result:** CT NOT DETECTED; NG DETECTED
- Sample Type:** Other
- Other Sample Type:** (empty field)
- Notes:** (empty text area)
- User Detail:** User
- Start Time:** 02/03/20 17:38:57
- End Time:** 02/03/20 19:06:02
- Status:** Done
- Upload Status:** NA
- For In Vitro Diagnostic Use Only:** (empty text area)

At the bottom, there are buttons for "Save Changes", "Export", "Report", "Upload Test", "Select Graphs", and "View Test".

Figure 5-34. GeneXpert Dx View Results Window—Results Tab (Basic Users View)

Note

Editable fields are shown on a white background. Non-editable fields have a gray background.

- **Patient ID**—This field is available if the **Use Patient ID** option is enabled. It is user-editable if it was not originated from a host order. If there is an asterisk (*) next to the field, the Patient ID was scanned.
- **Patient ID 2**—This field is available if the **Use Patient ID 2** option is enabled. It is user-editable if it was not originated from a host order.
- **Sample ID**—This field is user-editable if it was not originated from a host order. If there is an asterisk (*) next to the field, the Patient ID was scanned.
- **Assay**—Assay name. This field is not editable.

- **Version**—The assay version number. This field is not editable.
- **Result**—The test results shown in the Basic View Results window will be expanded to display all lines for multiple line results to support the maximum number of results for organism, genotyping, or % ratio assays. If the expansion is such that other information will no longer fit on the window, a scroll bar will allow viewing of the other information. The result is not editable.
- **User**—This field displays the name of the system operator who performed the test. It is not editable.
- **Sample Type**—This field is editable using a drop-down list of assay specific sample types.
- **Other Sample Type**—The **Other Sample Type** will contain text entered during the Create Test process or as a result of editing a test. It is editable if the **Sample Type** is **Other**; otherwise, it is not editable.
- **Notes**—This field displays any notes entered when the test was submitted. If additional notes are required, add or change the note information.
- **Start Time**—This non-editable field displays the test start date and time in the system configuration format.
- **End Time**—This non-editable field displays the test end date and time in the system configuration format.
- **Status**—The operational status of the test is displayed in this non-editable field. It will display **Done** if the test has completed. It may also display **RUNNING** if the test has not completed yet or **INCOMPLETE** if there were problems while running the test.
- **Upload Status**—(if host communication is enabled)—If host communication is enabled, a field will be shown indicating the upload status of the results. This field is not editable. It will display **Uploaded** if the test results have been uploaded or it may also display **Pending Upload** if the test has completed but the results have not been uploaded yet. This field is not displayed if host communication is not enabled.
- **Disclaimer**—This non-editable disclaimer text is shown after the test result is available depending on the assay and the result.

Some fields are editable if the system administrator has set up the system User Type Configuration to allow basic users to edit test details. To edit those fields:

1. Place the cursor in the desired field(s) and edit the fields, as needed.
2. Press the **Save Changes** button. The Save dialog box will be displayed.
3. Check that the **Save Test** radial button is enabled.
4. Press the **Yes** button to save the changes. Pressing the **Cancel** button returns to the View Results screen with the entered changes displayed. Pressing the **No** button returns to the View Results screen and discards the entered changes.

5.11.2.2 Errors Tab

The **Errors** tab lists the errors encountered during the test process and provides the following information (see [Figure 5-35](#)).

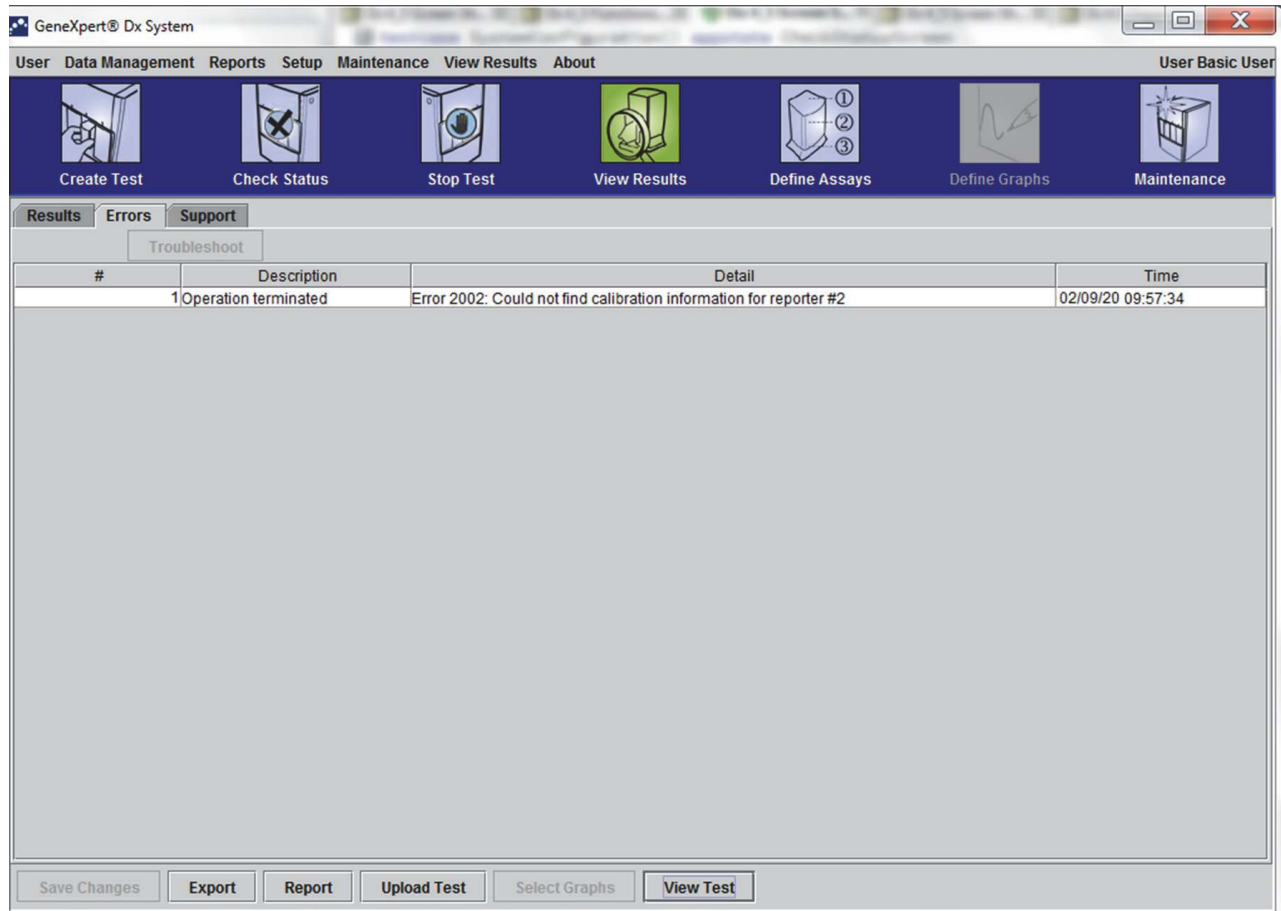

Figure 5-35. GeneXpert Dx View Results Window—Errors Tab (Basic Users View)

- **#**—The number that indicates the sequence in which the errors appeared during the test. It is not user-editable.
- **Description**—A description of the error type is displayed. It is not user-editable.
- **Detail**—Additional error information is provided about the error (e.g. **Error 2002: Could not find calibration.....**). It is not user-editable.
- **Time**—The time the error occurred is displayed. It is not user-editable.

See [Section 9.19.2, Error Messages](#) for a description of the error messages and the possible causes and potential solutions to the errors.

If there were no errors during the test, the **Errors** tab displays a blank table.

5.11.2.3 Support Tab

The **Support** tab displays the following information for a test (see Figure 5-36):

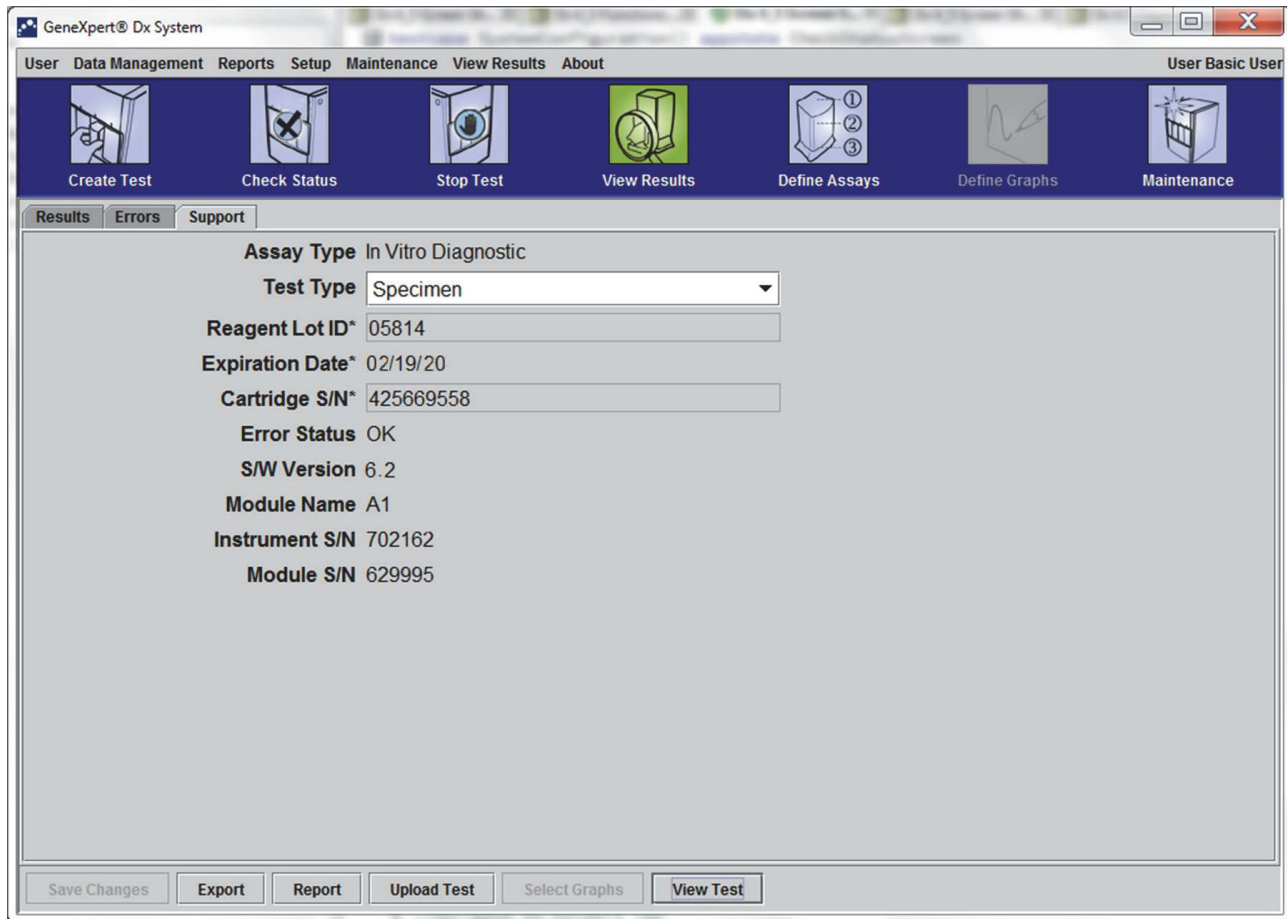

Figure 5-36. GeneXpert Dx View Results Window—Support Tab (Basic Users View)

- **Assay Type**—This is a non-editable field that displays the type of diagnostic test that was run. For most tests, it will display **In Vitro Diagnostic**.
- **Test Type**—This editable field displays type of test that was run. The drop-down can be set to either **Specimen** or various types of external controls.
- **Reagent Lot ID**—This field displays the reagent lot ID. If there is an asterisk (*) next to the field, the reagent lot ID was scanned from the cartridge. It is not editable if the associated assay is a factory assay that requires lot specific parameters or the cartridge barcode is scanned.
- **Expiration Date**—This non-editable field displays the cartridge expiration date. If there is an asterisk (*) next to the field, the cartridge expiration date was scanned from the cartridge.
- **Cartridge S/N**—This non-editable field displays the cartridge serial number. If there is an asterisk (*) next to the field, the cartridge serial number was scanned from the cartridge.

- **Error Status**—This non-editable field indicates if there were any errors during the test run. No errors are indicated by **OK**. If an error occurred while the test was running, the error status will be **Error**.
- **S/W Version**—This non-editable field displays the software version installed on the system at the time the test was run.
- **Module Name**—This non-editable field displays the name of the module in which the test was run (i.e. **A1**).
- **Instrument S/N**—This non-editable field displays the serial number of the instrument in which the test was run.
- **Module S/N**—This non-editable field displays the serial number of the module in which the test was run.

Editable if the system administrator has set up the system User Type Configuration to allow basic users to edit test details. To edit this field:

1. Click the drop down box for the Test Type field and select the desired test type.
2. Press the **Save Changes** button. The Save dialog box will be displayed.
3. Check that the **Save Test** radial button is enabled.
4. Press the **Yes** button to save the changes. Pressing the **Cancel** button returns to the View Results screen with the entered changes displayed. Pressing the **No** button returns to the View Results screen and discards the entered changes.

Note

Editable fields are shown on a white background. Non-editable fields have a gray background.

5.11.3 Detail User and Administrator View

Figure 5-37 shows the **View Results** window for **Detail** and **Administrator** users. The window is divided into four areas:

- **Test Information Area**—Displays information provided when you created the test, including the module used in the test, the Patient ID or Patient ID 2 (if they are enabled), Sample ID, assay information, and cartridge information. You can edit and save the Patient ID, Patient ID 2, Sample ID, Test Type information, Sample Type, Other Sample Type, and text in the Notes box (see [Section 5.12, Editing the Test Information](#)). Do not use the following symbols in this area: | @ ^ ~ \ & / : * ? " < > ' \$ % ! ; () - .
- **Views Area**—Allows you to arrange the display of the results and growth curve areas. For example, you can display the growth curve area above the results area.
- **Results Area**—Allows you to view the information in the following tabs: **Test Result**, **Analyte Result**, **Detail**, **Errors**, **History**, and **Support**.

- Growth Curve Area**—Displays a graph that plots the number of cycles on the X-axis and the fluorescence units on the Y-axis for each analyte. The graph reflects the curve analysis specified in the assay definition. Using this graph, you can visually inspect the rate at which the fluorescence signal increases.

To display or hide an analyte graph, select the analyte name in the graph legend to the right of the graph. In addition, you can change the magnification of the graph in the X or Y direction by clicking and dragging the horizontal or vertical slider next to the X- and/or Y-axes.

5.11.3.1 Test Result Tab

The **Test Result** tab of the View Results window displays the following information for a test (see [Figure 5-37](#)).

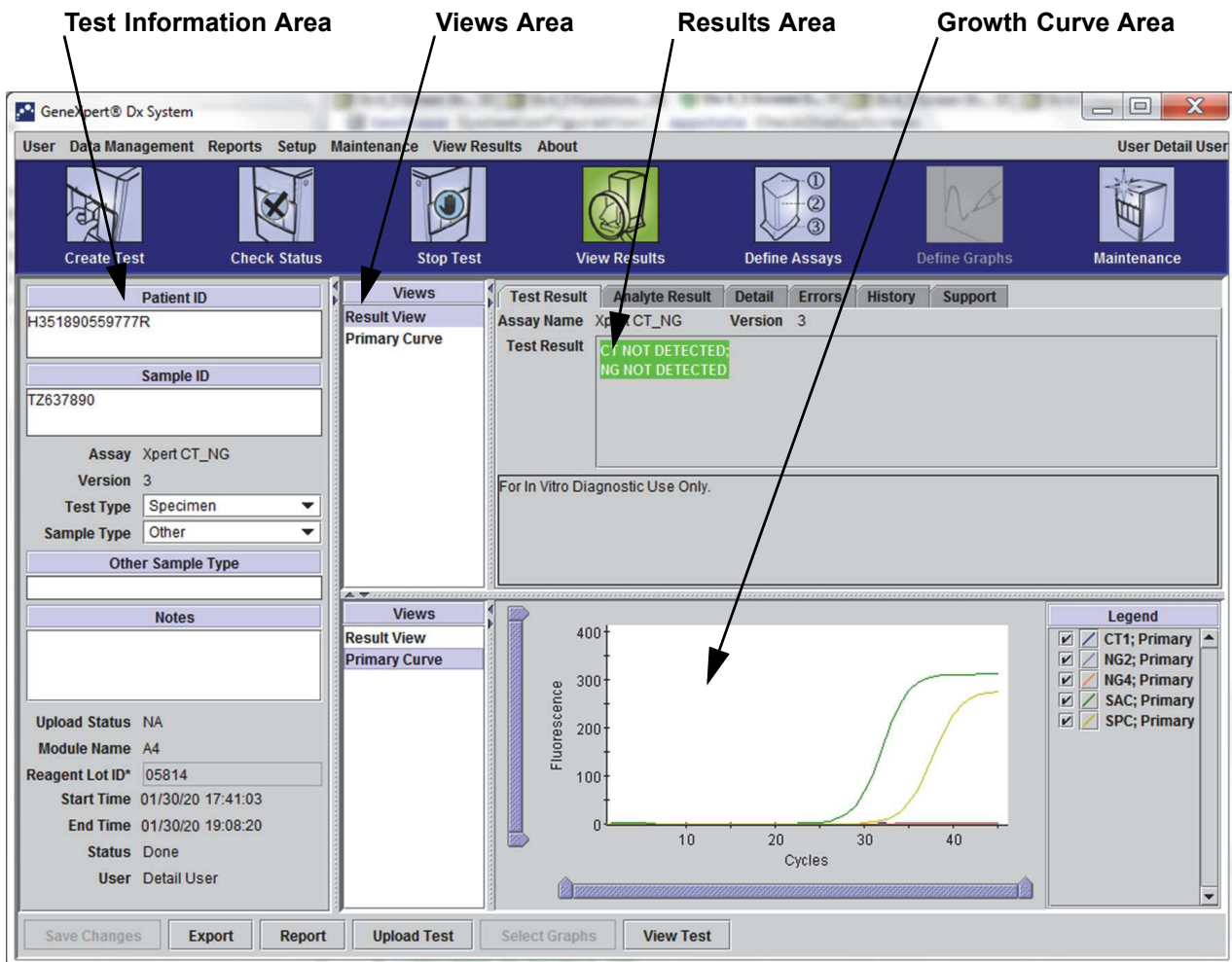

Figure 5-37. GeneXpert Dx View Results Window—Test Result Tab (Detail Users and Administrator View)

- Assay Name**—The name of the assay. This field is not editable.
- Version**—The assay version number. This field is not editable.

- **Test Result**—The test results shown in the Detail View Results will be expanded to display all lines for multiple line results to support the maximum number of results for organism, genotyping, or % ratio assays. If the expansion is such that other information will no longer fit on the window, a scroll bar will allow viewing of the other information. The Test Result is not editable.
- **Disclaimer**—This non-editable disclaimer text is shown after the test result is available depending on the assay and the result.

Note There are no editable fields on the **Test Result** tab.

5.11.3.2 Analyte Result Tab

The **Analyte Result** tab displays the following information in tabular form (see Figure 5-38).

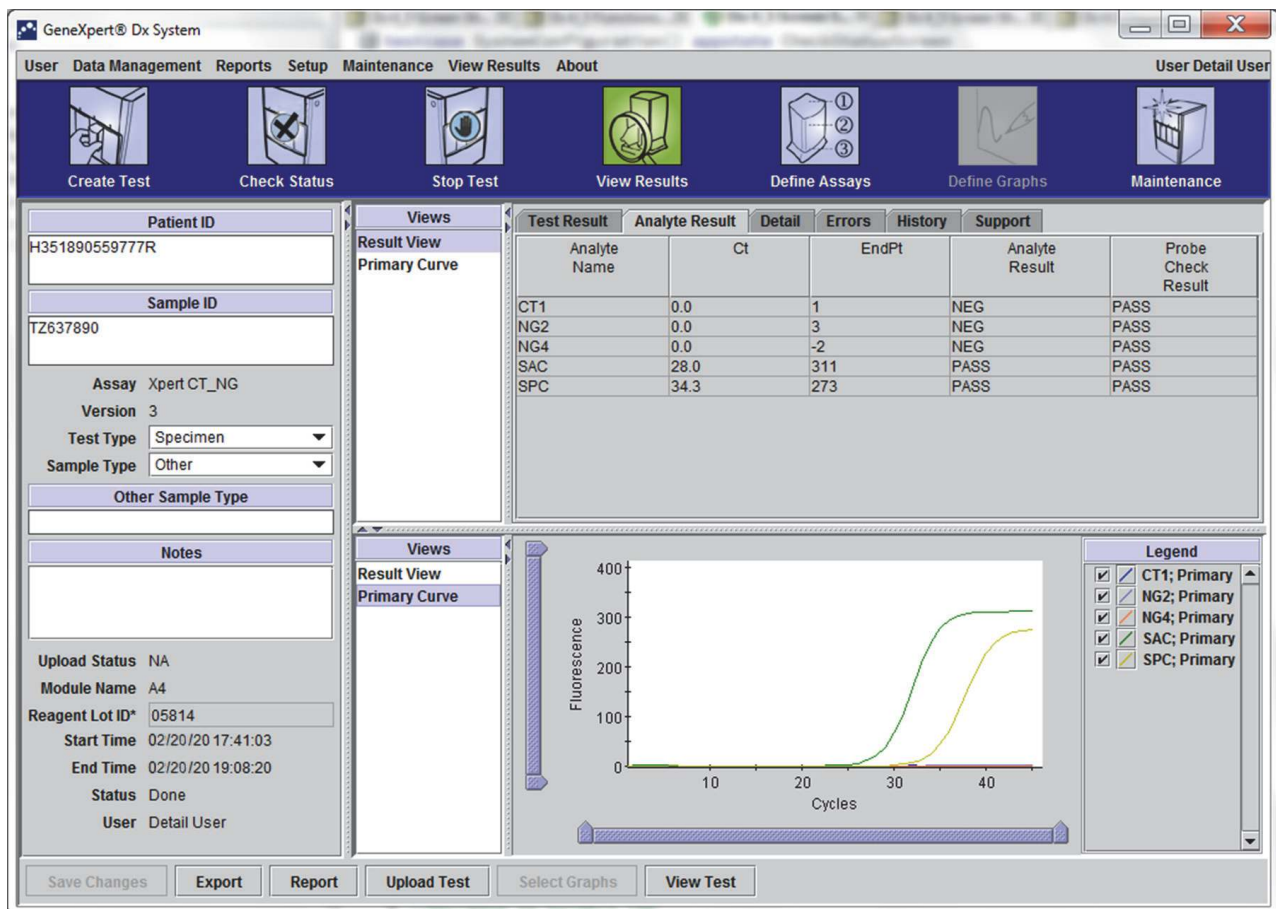

Figure 5-38. GeneXpert Dx View Results Window—Analyte Result Tab (Detail Users and Administrator View)

- **Analyte Name**—The analyte that was tracked during the test process. The possible analytes are the name of the test target, IC (internal control), or SPC (sample processing control), and EC (endogenous control).

- **Ct**—The first cycle in which the fluorescence signal reaches a specified threshold. The threshold cycle (Ct) is determined from the growth curve.
- **EndPt**—The endpoint value of the growth curve in fluorescence units.
- **Analyte Result**—The result for each analyte processed. The results are displayed after the test is finished.
- **Probe Check Result**—The result of the probe check, the process that verifies presence and integrity of the probes in the master mix. Possible values are **PASS**, **FAIL** and **NA** if the assay does not include a probe check. The probe check passes if the measured fluorescence values together meet the predetermined validated acceptance criteria.

Note

There are no editable fields on the **Analyte Result** tab.

5.11.3.3 Detail Tab

The **Detail** tab displays the detailed probe check results if the assay specifies the use of a probe check (see [Figure 5-39](#)). In addition, the second derivative peak height value (for the combination curve), melt peaks, and curve fit result are available if the assay definition specified their use.

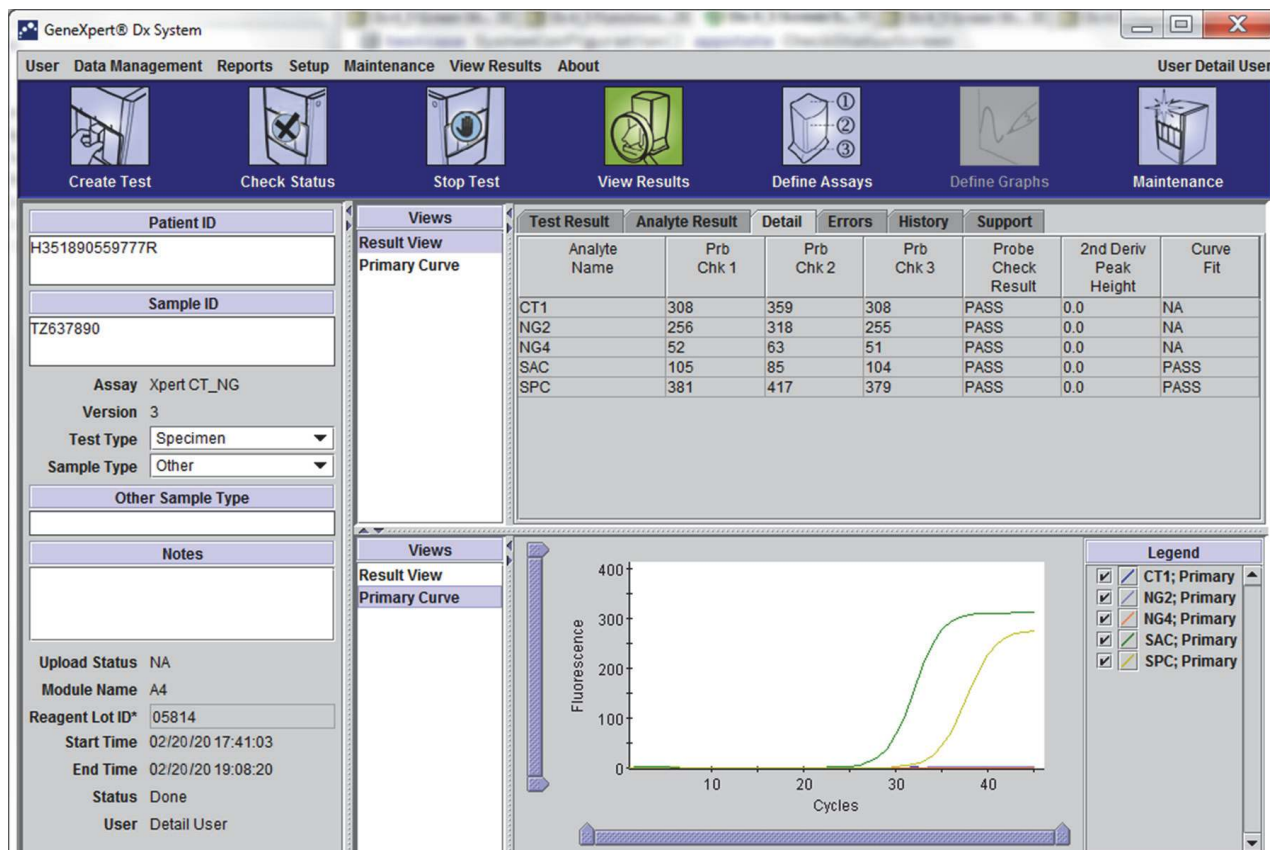

Figure 5-39. GeneXpert Dx View Results Window—Detail Tab (Detail Users and Administrator View)

As shown in [Figure 5-39](#), the **Detail** tab of the View Results window provides the following miscellaneous data for test results:

- **Analyte Name**—Description of the reference targets that aid in the detection of a specific assay.
- **Prb Chk 1**—Probe check 1 data are the results of fluorescent measurements of dye specific to each analyte.
- **Prb Chk 2**—Probe check 2 data are the results of fluorescent measurements of dye specific to each analyte.
- **Prb Chk 3**—Probe check 3 data are the results of fluorescent measurements of dye specific to each analyte.

- **Probe Check Result**—Before the start of the PCR reaction, the GeneXpert Dx system measures the fluorescence signal from the probes to monitor bead rehydration, reaction-tube filling, probe integrity and dye stability. Probe Check passes if it meets the assigned acceptance criteria.
- **2nd Derivative Peak Height**—The highest peak of the 2nd derivative represents the point of maximum curvature of the growth curve. The threshold defines only a minimum peak height for determining Ct. If the 2nd derivative peak is above the threshold, a Ct is reported. If the peak is below the threshold, no Ct is reported.
- **Curve Fit**—This section is selected by default in the dialog. Curve Fit substitutes the modeled curve fit data to reduce false positives that may occur due to optical noise, drift or other curve anomalies, by smoothing the curve. For example a noise spike in a curve could trigger the primary threshold, indicating a positive whereas an experienced operator would call the result as a negative.

Note

There are no editable fields on the **Detail** tab.

5.11.3.4 Errors Tab

The **Errors** tab lists the errors encountered during the test process and provides the following information (see [Figure 5-40](#)).

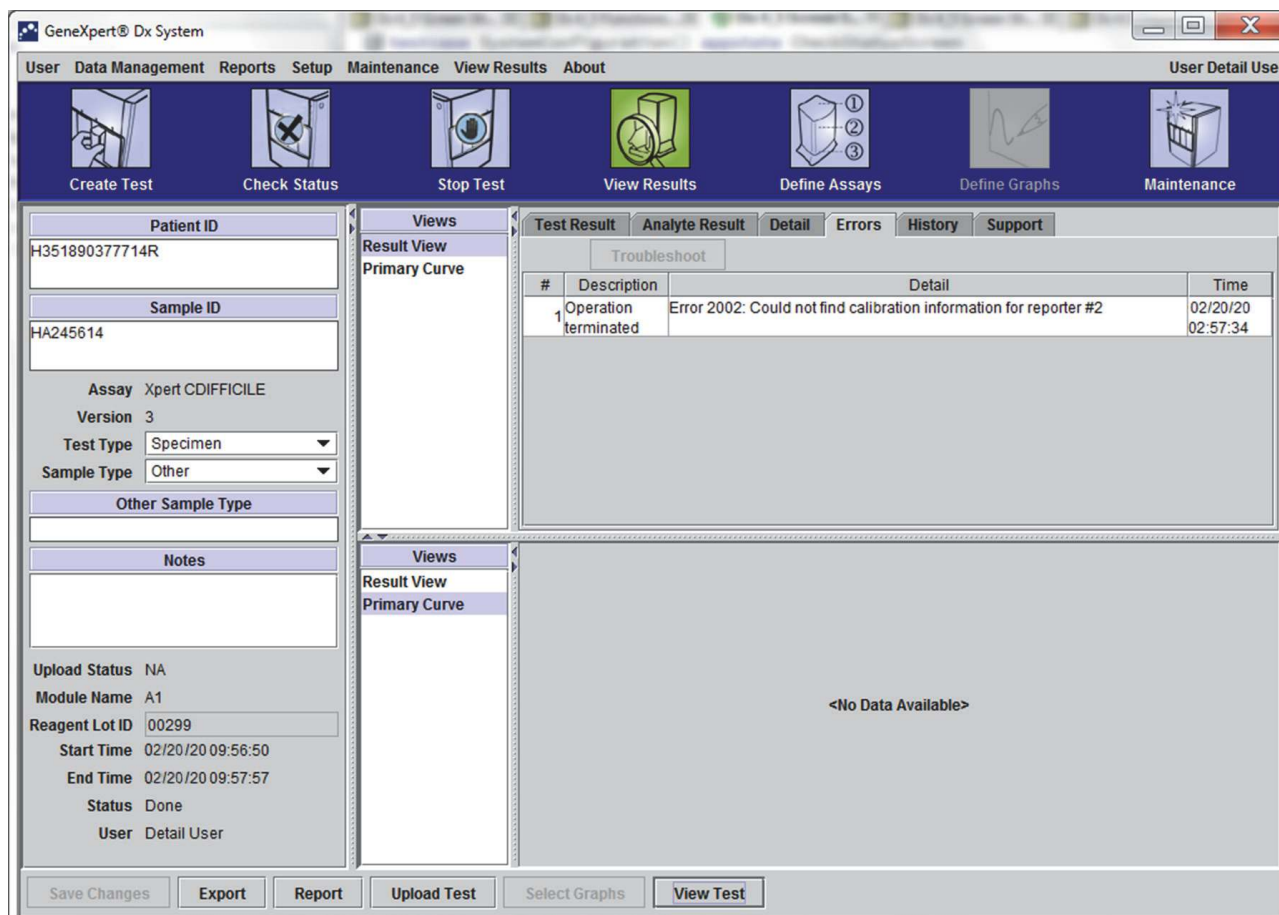

Figure 5-40. GeneXpert Dx System—View Results Window—Errors Tab (Detail Users and Administrator View)

- **#**—The number that indicates the sequence in which the errors appeared during the test. It is not user-editable.
- **Description**—A description of the error type is displayed. It is not user-editable.
- **Detail**—Additional error information is provided about the error (e.g. **Error 2002: Could not find calibration.....**). It is not user-editable.
- **Time**—The time at which the error occurred is displayed. It is not user-editable.

See [Section 9.19.2, Error Messages](#) for a description of the error messages and the possible causes and potential solutions to the errors.

If there were no errors during the test, the **Errors** tab displays a blank table.

5.11.3.5 History Tab

The **History** tab displays a log of revisions made to the test information (see [Figure 5-41](#)). The log includes the original information, the revised information, the user who revised the information, and the date and time of the revision.

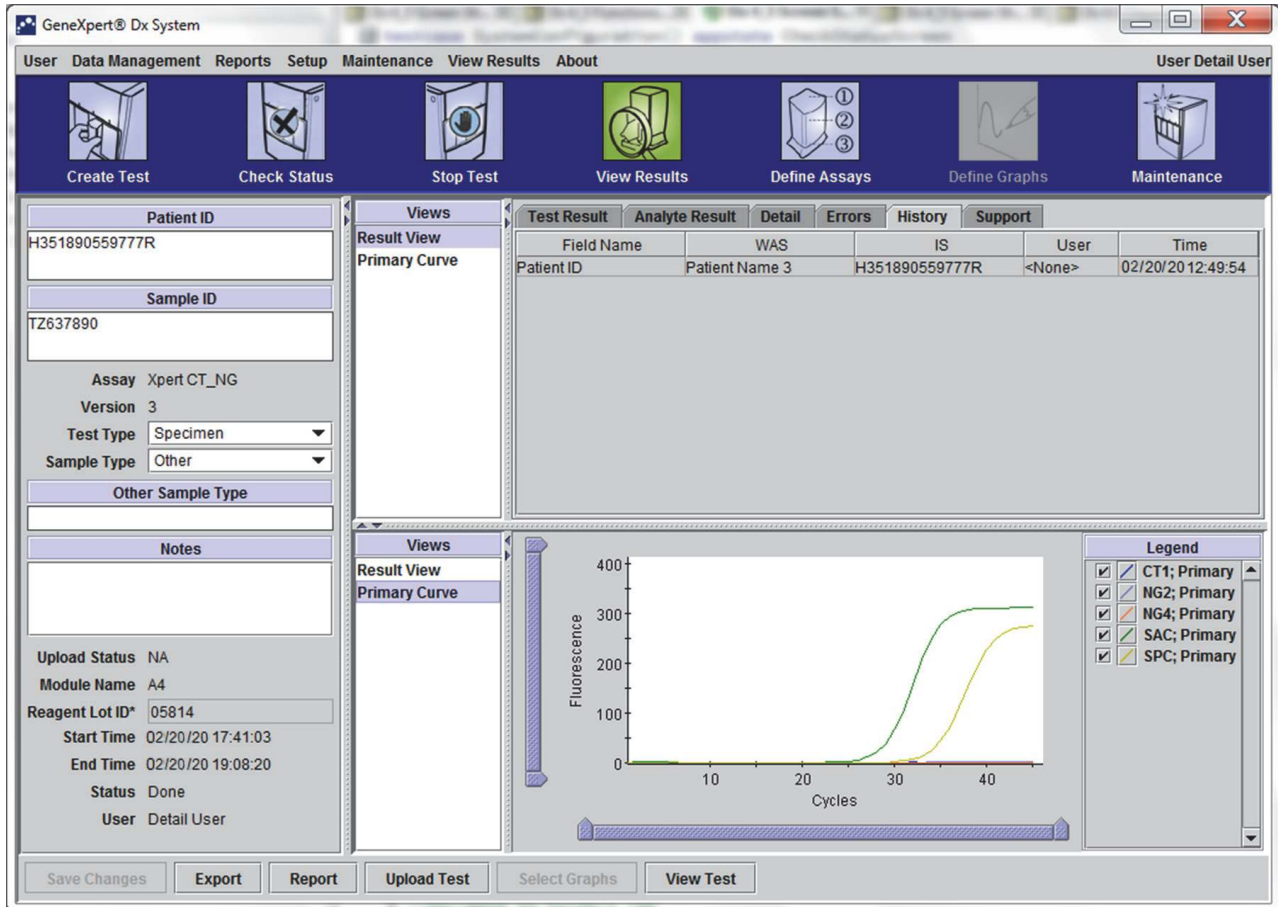

Figure 5-41. GeneXpert Dx View Results Window—History Tab (Detail Users and Administrator View)

See [Section 5.12, Editing the Test Information](#) for instructions on how to edit information in the View Results window and save the change(s) into the **History** tab window.

5.11.3.6 Support Tab

The **Support** tab for the Detail users and Administrator users displays the following information for a test (see [Figure 5-42](#)):

- **Assay Type**—This is a non-editable field that displays the type of diagnostic test that was run. For most tests, it will display **In Vitro Diagnostic**.
- **Cartridge S/N**—This non-editable field displays the cartridge serial number. If there is an asterisk (*) next to the field, the cartridge serial number was scanned from the cartridge.
- **Expiration Date**—This non-editable field displays the cartridge expiration date. If there is an asterisk (*) next to the field, the cartridge expiration date was scanned from the cartridge.

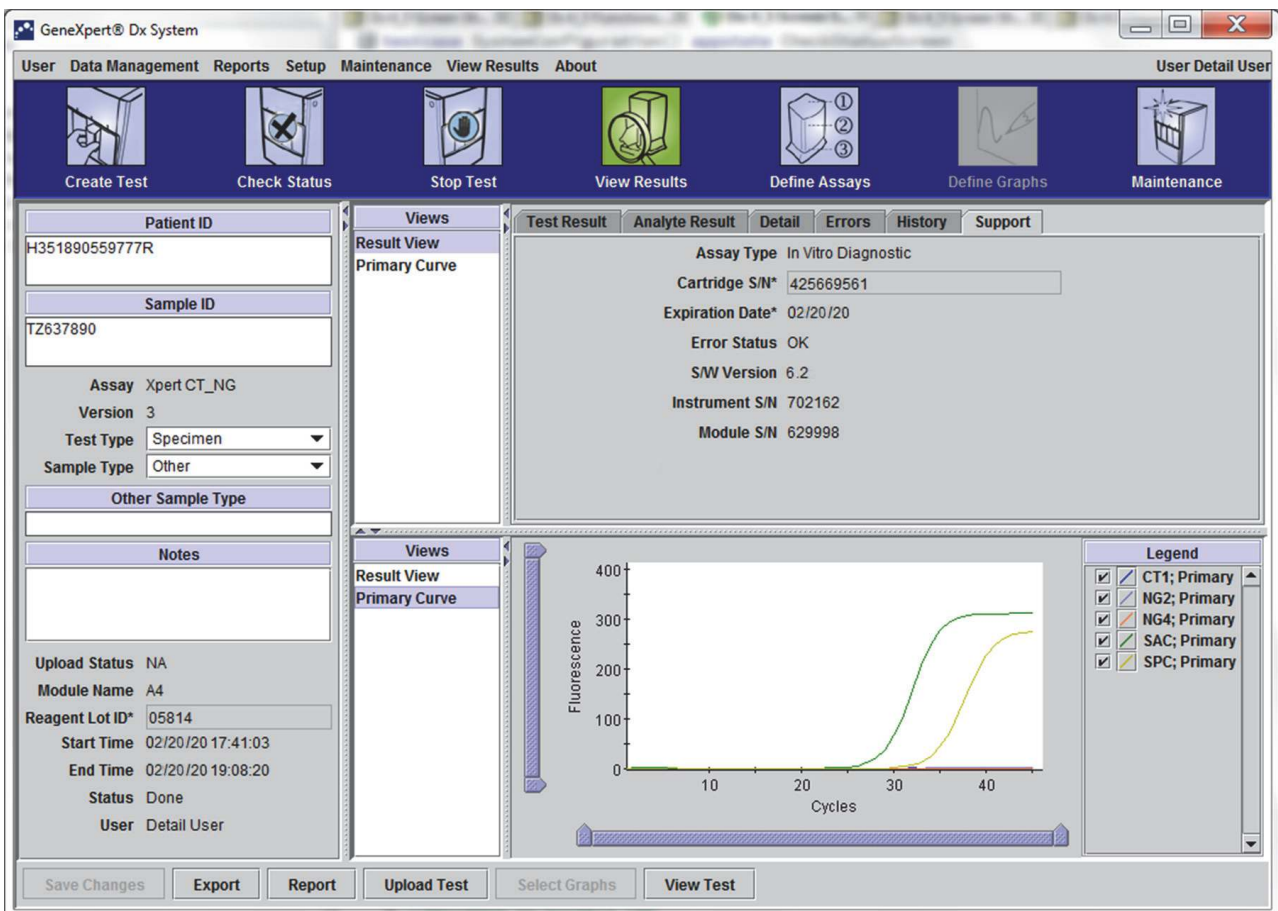

Figure 5-42. GeneXpert Dx View Results Window—Support Tab (Detail Users and Administrator View)

- **Error Status**—This non-editable field indicates if there were any errors during the test run. No errors are indicated by **OK**. If an error occurred while the test was running, the error status will be **Error**.
- **S/W Version**—This non-editable field displays the software version installed on the system at the time the test was run
- **Instrument S/N**—This non-editable field displays the serial number of the instrument in which the test was run
- **Module S/N**—This non-editable field displays the serial number of the module in which the test was run.

Note There are no user-editable fields on the **Support** tab.

5.12 Editing the Test Information

Important

Make sure you scan or type the correct Sample ID, Patient ID and Patient ID2. The Sample ID, Patient ID and Patient ID2 is associated with the test results and is shown in the View Results window and all the reports.

For each test, you can edit the Patient ID and Patient ID 2 (if they are enabled), Sample ID, Test Type, Sample Type, Other Sample Type, and Notes. To do this, in the View Results window (see [Figure 5-43](#)), edit the Sample ID, Test Type, Sample Type, Other Sample Type and Notes (see [Figure 5-43](#)). Sample IDs cannot include the following characters: | @ ^ ~ & / : * ? " < > ' \$ % ! ; () -.

To demonstrate the **History** tab feature:

1. In the GeneXpert Dx System window, click **View Results** on the menu bar. The **Test Result** tab is displayed. See [Figure 5-43](#).
2. Click the **History** tab in the View Results screen (see [Figure 5-44](#)). The **History** tab is displayed, showing that no changes have been made to the test. See [Figure 5-45](#).

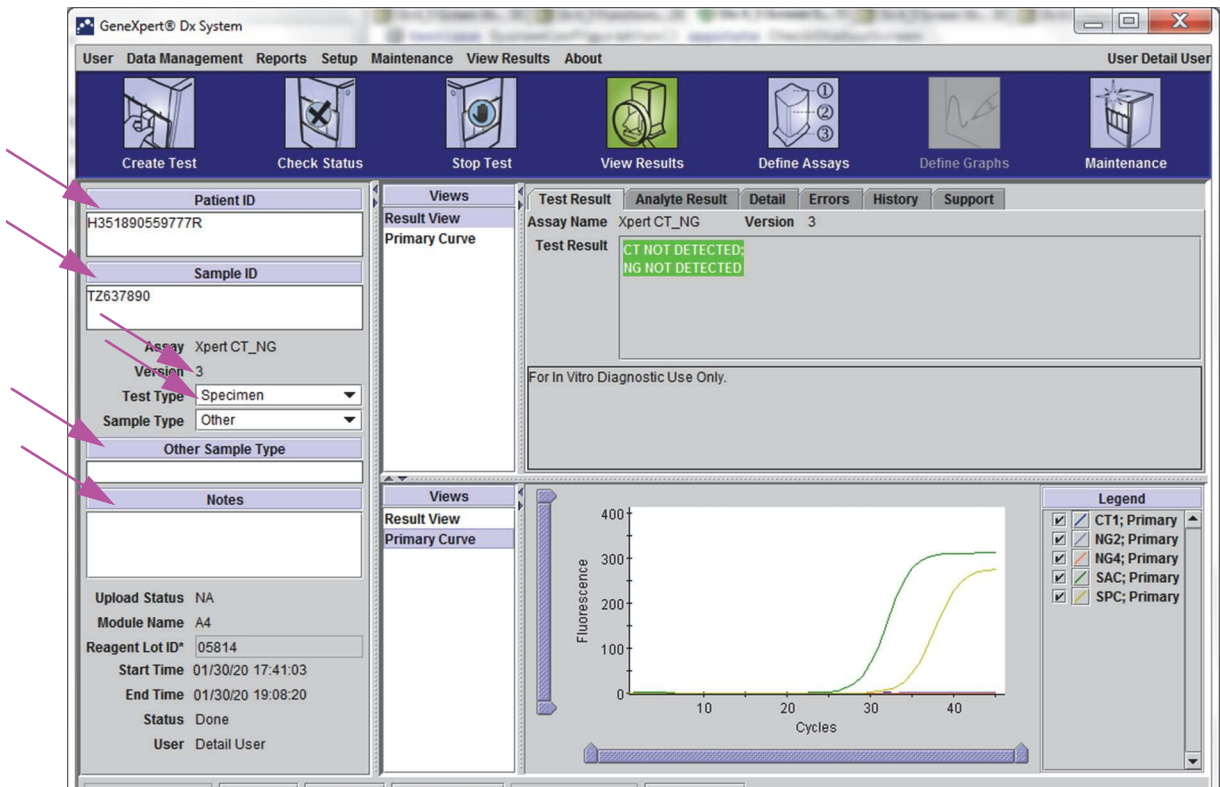

Figure 5-43. GeneXpert Dx View Results Window (Detail Users and Administrator View)

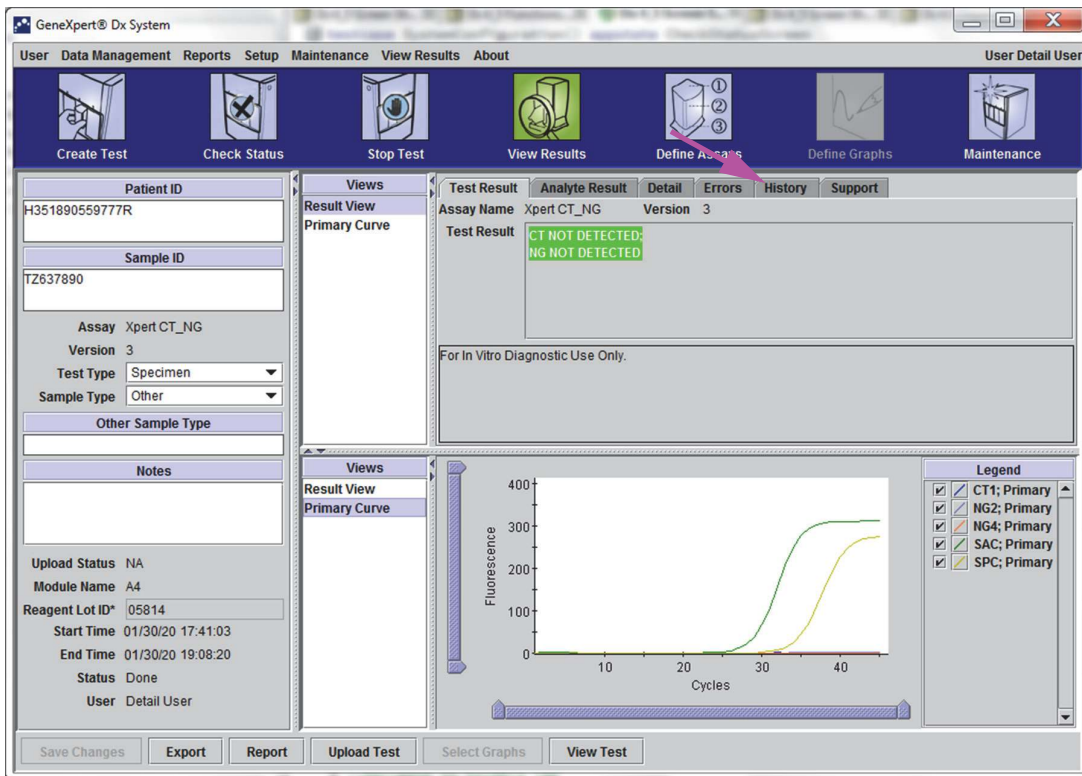

Figure 5-44. GeneXpert Dx System, View Results Window (Detail Users and Administrator View)

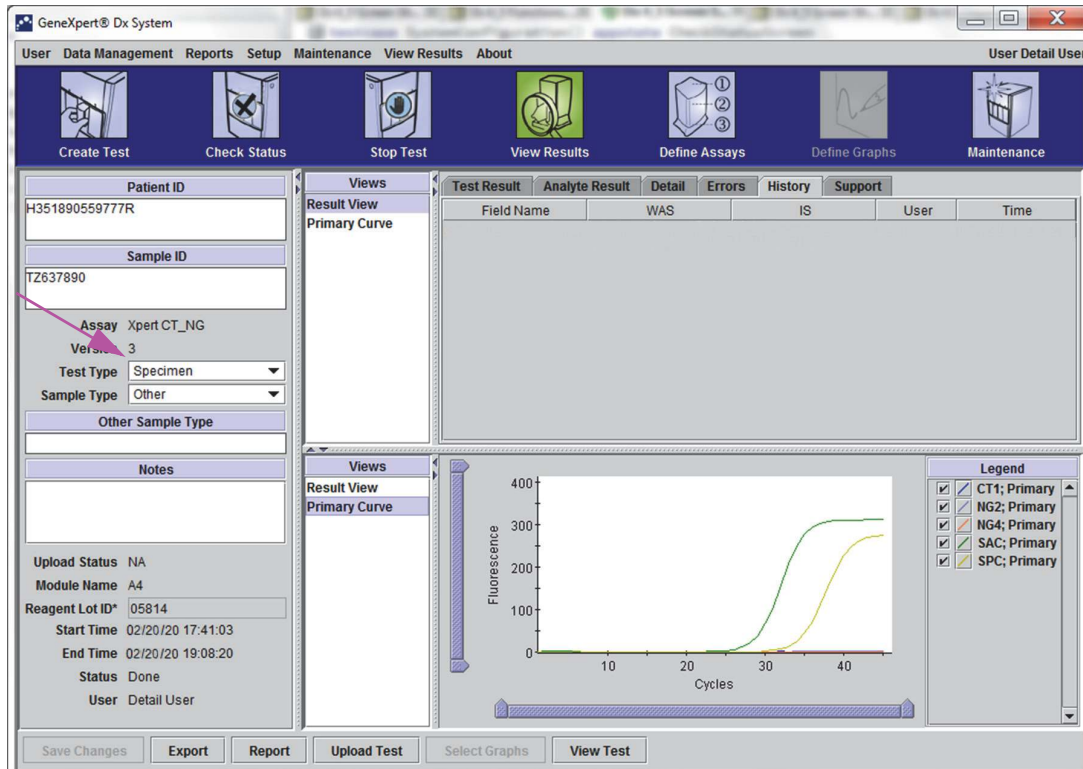

Figure 5-45. GeneXpert Dx View Results Window—History Tab Selected

3. Change Test Type to Negative Control as shown in Figure 5-46.

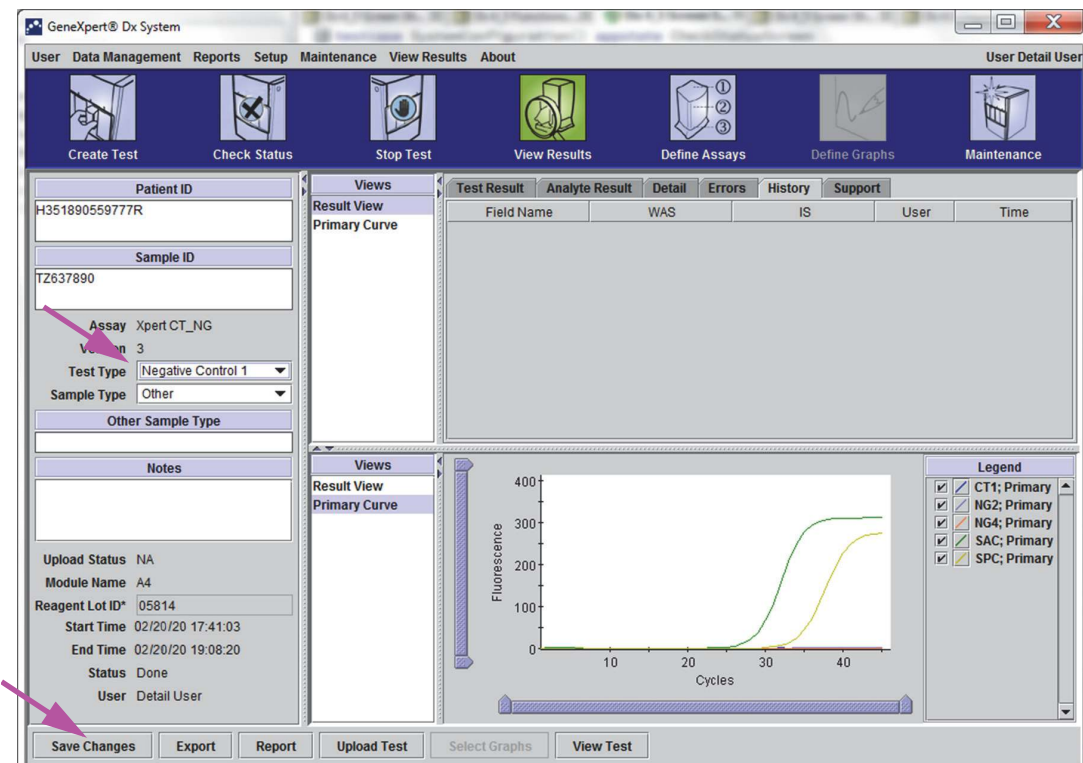

Figure 5-46. GeneXpert Dx View Results Window—Test Type Changed

- Click the **Save Changes** button located at the bottom of the View Results window (see Figure 5-46). The Save Test dialog box appears. See Figure 5-47.

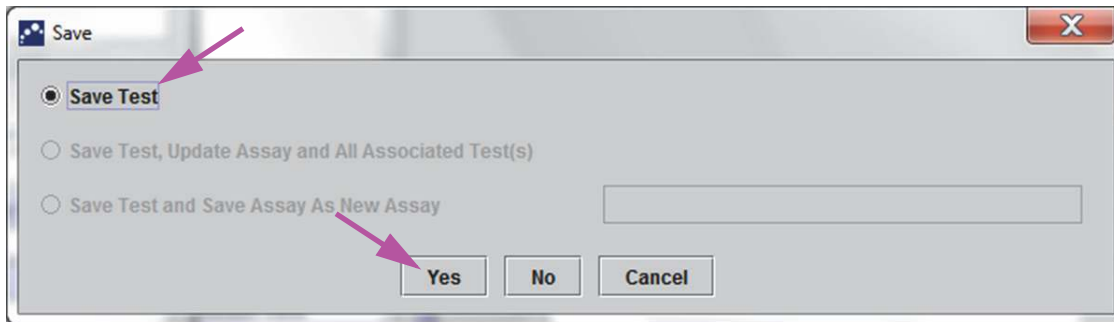

Figure 5-47. Save Dialog Box

- Click **Yes** to save the changes and proceed. The software tracks the change history (see Figure 5-48).
 Click **No** to not save changes. The previous screen is displayed and all edits are discarded.
 Click **Cancel** to not proceed and stay in the same window. Any edits made to the window will remain but will not be saved.

Note If changes have been made to a window, the Save dialog box will be displayed for any operation that will open another window.

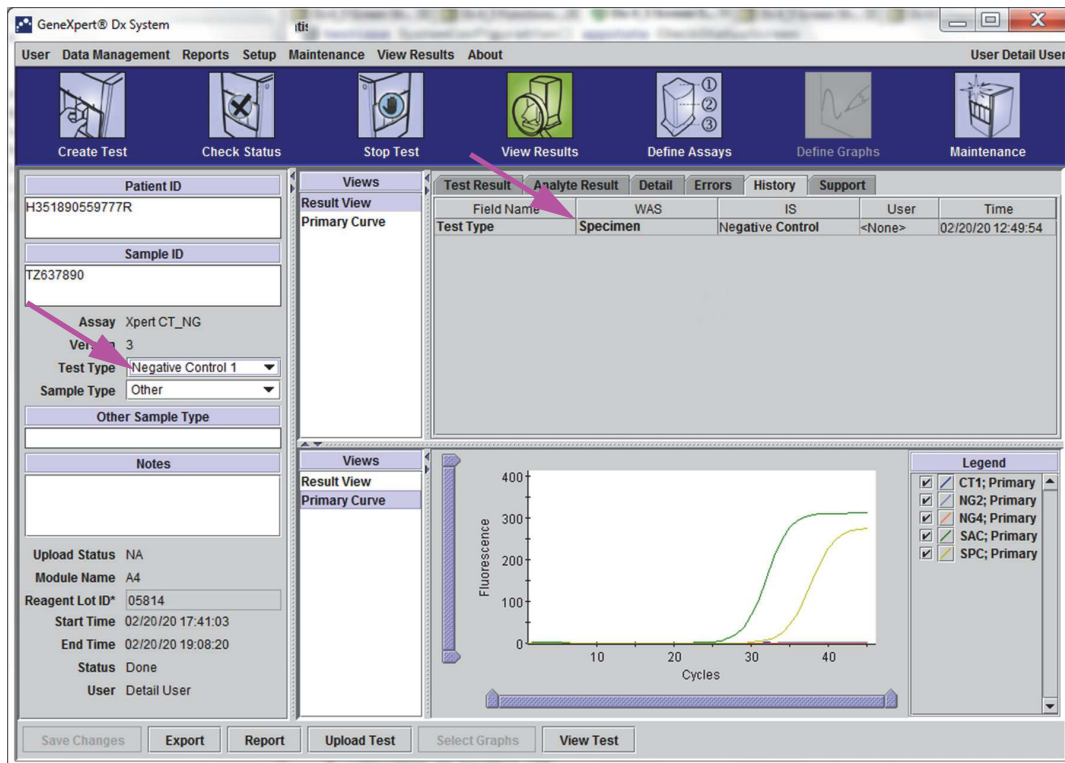

Figure 5-48. History Tab showing Change from Specimen to Negative Control Test Type

5.13 Generating Test Result Reports

Important

To ensure all data is displayed correctly, reports must be generated in the same language that was used when the test results were collected.

Depending upon the level of detail required, two test reports are available. The Basic user test report shows test results and test information. The Administrator and Detail user test report shows test results, test information and analyte result information as selected by the options in the Select Test to be Viewed dialog box.

- For Basic user test reports, see [Section 5.13.1, Test Result Reports for Basic Users](#).
- For Detail and Administrator test reports, see [Section 5.13.2, Test Result Reports for Detail and Administrator Users](#).

To generate a PDF file containing the test results, in the View Results window (see [Figure 5-34](#) or [Figure 5-37](#)), click the **Report** button.

5.13.1 Test Result Reports for Basic Users

Note

If analyte results and the amplification curve is required, the test report should be created by a Detail user or an Administrator user. See [Section 5.13.2, Test Result Reports for Detail and Administrator Users](#).

For Basic users, the software creates a PDF file and displays the file in the Adobe Reader window. You can save and print the PDF file from the Adobe Reader software. For instructions on how to use Adobe Reader, click the **Adobe Reader Help** selection under the Adobe Reader **Help** menu.

To generate a test result report:

1. Click the **View Results** button and select the desired test in the window that appears. Click **OK** to open the test.

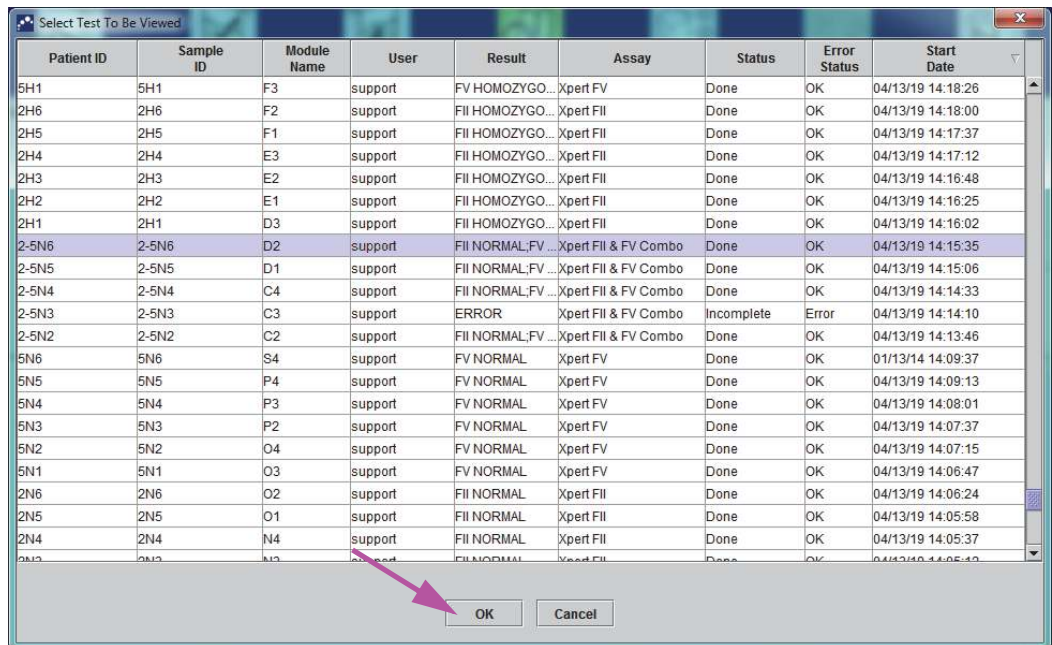

Figure 5-49. Select Test to Be Viewed Dialog

2. Click the **Report** button to create a PDF file.

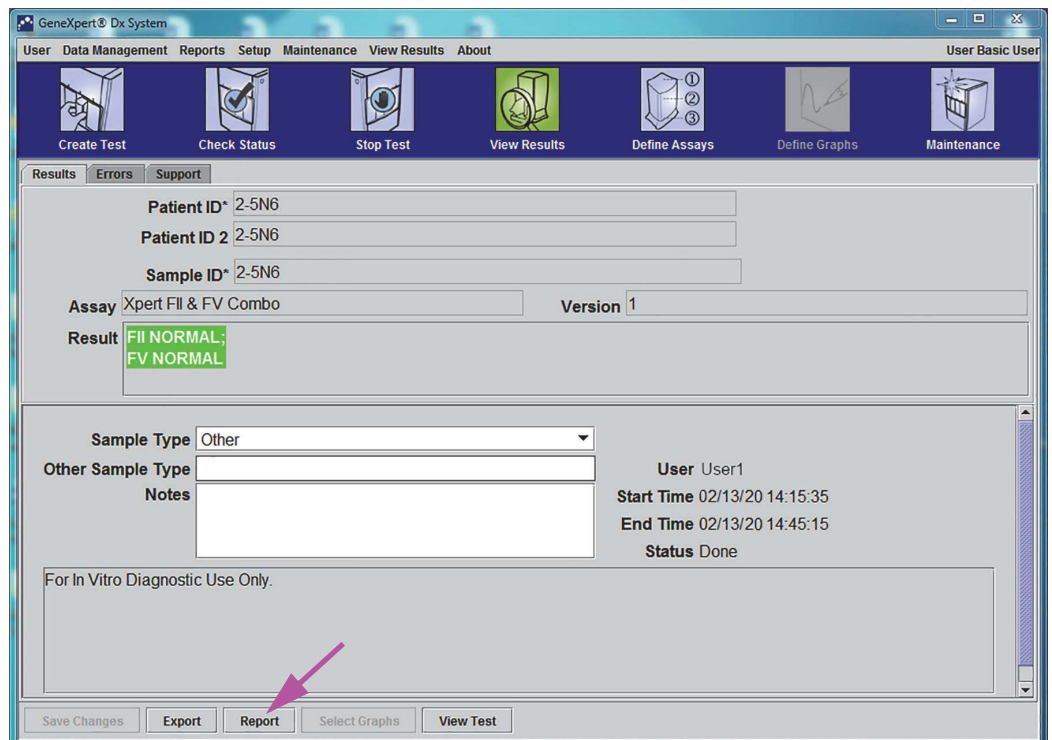

Figure 5-50. Select Report to Generate PDF

Operating Instructions

- The PDF file opens in the Adobe Reader window. The PDF file can be saved or printed from the Acrobat software. For instructions on how to use Adobe Reader, click the **Adobe Reader Help** selection under the Adobe Reader **Help** menu.

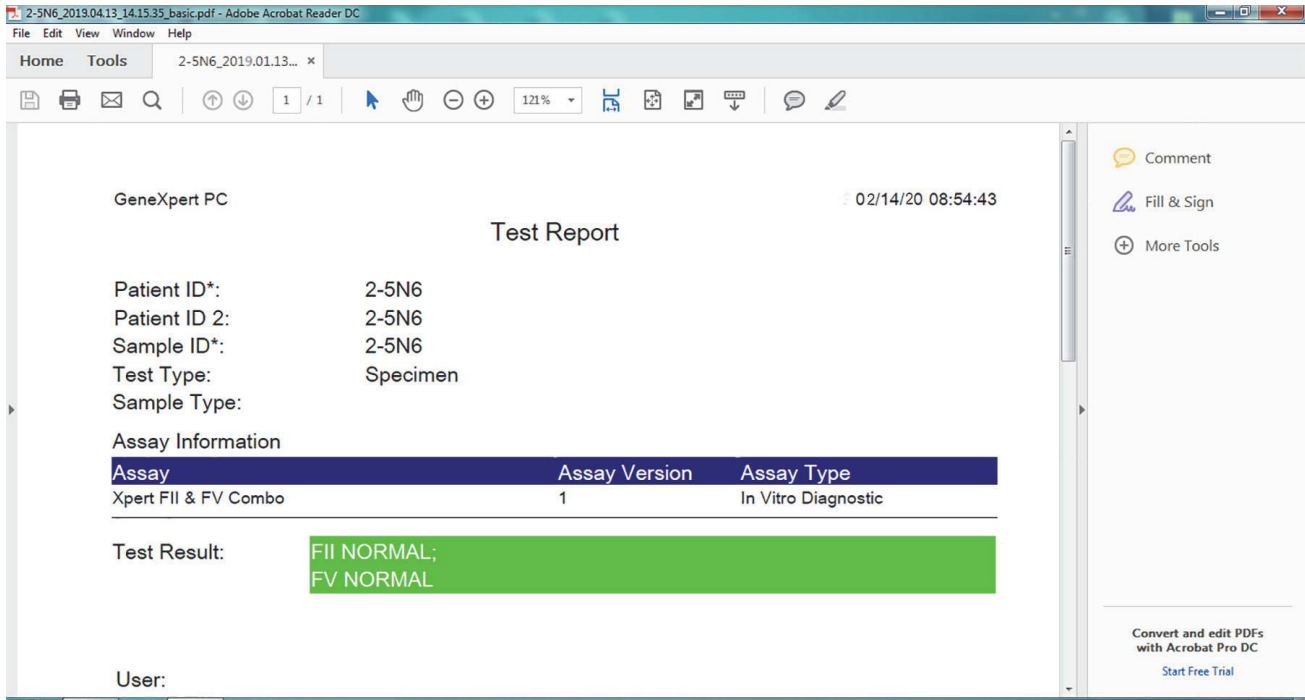

Figure 5-51. Basic Report Opened in Adobe Reader

GeneXpert PC		02/14/20 08:54:43	
Test Report			
Patient ID*:	H351885382682R		
Patient ID 2:			
Sample ID*:	HN237945		
Test Type:	Specimen		
Sample Type:			
Assay Information			
Assay	Assay Version	Assay Type	
Xpert FII & FV Combo	1	In Vitro Diagnostic	
Test Result:	FII NORMAL; FV NORMAL		
User:	Basic1	Start Time:	02/13/20 14:15:35
Status:	Done	End Time:	02/13/20 14:45:15
Expiration Date*:	11/16/20	Instrument S/N:	801225
S/W Version:	6.2	Module S/N:	607389
Cartridge S/N*:	116820908	Module Name:	D2
Reagent Lot ID*:	04701		
Notes:			
Errors	<None>		
_____ Tech. Initial/Date		_____ Supervisor Initial/Date	
* indicates that a particular field is entered using a barcode scanner			
For In Vitro Diagnostic Use Only.			
GeneXpert® Dx System Version 6.2	CONFIDENTIAL	Page 1 of 1	

Figure 5-52. Example Test Report—Basic User

5.13.2 Test Result Reports for Detail and Administrator Users

For Detail users and the administrator, the software allows the user to configure the Test Report before generating a PDF.

To generate a test result report:

1. Click the **View Results** button. Select the test(s) to add to the report by clicking the check box(es) to the left of the item(s).

Important

Sometimes only part of the result information is shown in the Result column of the Test Report dialog box. To see the rest of the result information, move the mouse's cursor over the Result column.

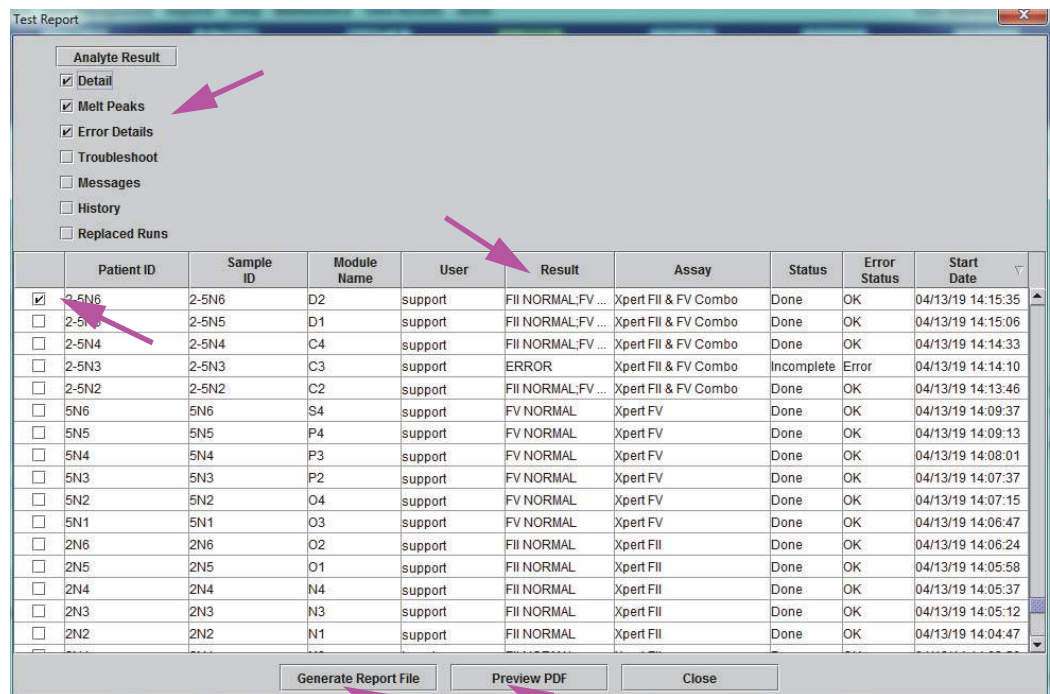

Figure 5-53. Select Test to Be Viewed Dialog

2. In the upper left-hand corner of the dialog box, several types of information are available. Select the information you want to include in the report by clicking the check box(es) to the left of the item(s):

- **Detail**—Select to include information from the **Detail** tab in the report such as analyte names, probe check values and results, second derivative peak height and curve fit.
- **Melt Peaks**—Select to include melt peaks in the report, if applicable.

- **Error Details**—Select to include any error details from the **Errors** tab, if applicable.
- **Troubleshoot**—Select to include troubleshooting information in the report, if applicable.
- **Messages**—Select to include messages in the report relating to the test, if applicable.
- **History**—Select to include any changes made to the test results from the **History** tab, if applicable.
- **Replaced Runs**—Do not select this check box; it is reserved for future functionality.
- The **Analyte Result** button allows the user to select specific information to include in the Analyte Result section of the report (see [Figure 5-54](#)).

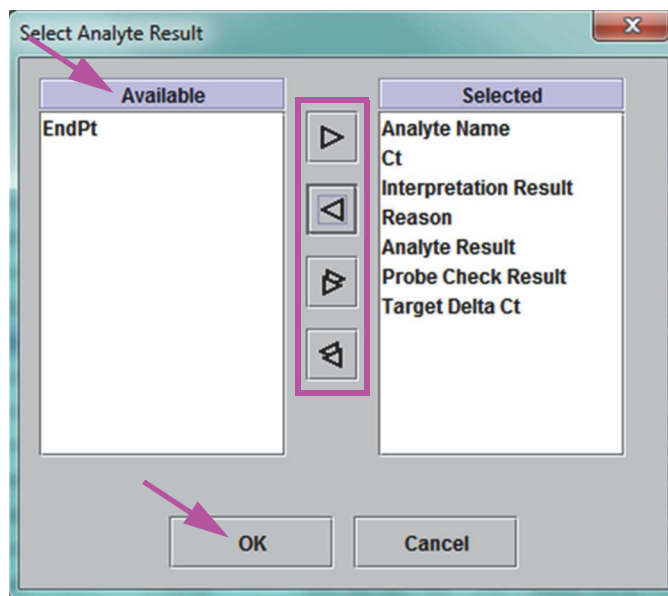

Figure 5-54. Select Analyte Result Dialog Box

To include specific analyte data in the report, select one or more of the items from the **Available** column and click the right arrow button to move them to the **Selected** column. To exclude specific analyte data from the report, select one or more of the items from the **Selected** column and click the left arrow button to move them to the **Available** column. All items can be either included or excluded by the report by clicking the double right arrow button or the double left arrow button. After selecting the analyte data items, click the **OK** button to close the Select Analyte Result dialog box.

3. When all selections have been made, click one or both of the following buttons on the Test Report dialog box:
 - **Generate Report File**—Creates a PDF file and saves it in the default location or a location you specify.
 - Click the **Generate Report File** button on Test Report workspace (see [Figure 5-53](#)) to create the PDF file of the test report. The Generate Report File dialog box will appear, which enables you to save the file to a specified location. Click **Save** once you have navigated to the specified location.
 - Optionally, to print the report, go to the saved location, open the test report and print it. A test report similar to the test report shown in [Figure 5-55](#) and [Figure 5-56](#) will be printed. The last page of the test report contains a signature block for approval of printed test reports.

Note

The test report shown in [Figure 5-55](#) and [Figure 5-56](#) have the Detail, **Melt Peaks**, and **Error Details** options selected. Specific test reports may be longer or shorter depending upon the options selected and the items applicable to the test.

- **Preview PDF**—Creates a PDF file and displays the file in the Adobe Reader window. The PDF file can be saved or printed from the Acrobat software. For instructions on how to use Adobe Reader, click the **Adobe Reader Help** selection under the Adobe Reader **Help** menu.
 - **Close**—After generating the test report(s), click **Close** to close the Test Report window.
4. If **Print Test Report At End of Test** is enabled, the report will automatically print each test report after the test is completed. See [Section 2.14, Configuring the System](#).

GeneXpert PC 02/14/20 09:01:20

Test Report

Patient ID*: H351885382682R
 Patient ID 2:
 Sample ID*: HN237945
 Test Type: Specimen
 Sample Type:

Assay Information

Assay	Assay Version	Assay Type
Xpert FII & FV Combo	1	In Vitro Diagnostic

Test Result: FII NORMAL;
FV NORMAL

Analyte Result

Analyte Name	Ct	EndPt	Analyte Result	Probe Check Result
FII 20210G	24.4	461	POS	PASS
FII 20210A	0.0	20	NEG	PASS
FV 1691G	25.1	347	POS	PASS
FV 1691A	0.0	17	NEG	PASS

Detail

Analyte Name	Prb Chk 1	Prb Chk 2	Prb Chk 3	Probe Check Result	2nd Deriv Peak Height	Curve Fit
FII 20210G	125	221	126	PASS	0.0	NA
FII 20210A	46	179	47	PASS	0.0	NA
FV 1691G	57	166	58	PASS	0.0	NA
FV 1691A	40	119	41	PASS	0.0	NA

Melt Peaks
<Not applicable>

For In Vitro Diagnostic Use Only.

GeneXpert® Dx System Version 6.2 CONFIDENTIAL Page 1 of 2

Figure 5-55. Example Test Report—Detail and Administrator User Page 1

GeneXpert PC		02/14/20 09:01:20	
Test Report			
User:	Detail1	Start Time:	02/13/20 14:15:35
Status:	Done	End Time:	02/13/20 14:45:15
Expiration Date*:	11/16/20	Instrument S/N:	801225
S/W Version:	6.2	Module S/N:	607389
Cartridge S/N*:	116820908	Module Name:	D2
Reagent Lot ID*:	04701		
Notes:			
Error Status:	OK		
Errors			
<None>			
_____		_____	
Tech. Initial/Date		Supervisor Initial/Date	
* indicates that a particular field is entered using a barcode scanner			
For In Vitro Diagnostic Use Only.			
GeneXpert® Dx System Version 6.2		CONFIDENTIAL	Page 2 of 2

Figure 5-56. Example Test Report—Detail and Administrator User Page 2

5.14 Exporting the Test Results

Important

To ensure all data is displayed correctly, reports must be generated in the same language that was used when the test results were collected.

To export the test results to a comma-separated value (.csv) file, in the View Results window (see [Figure 5-34](#) or [Figure 5-37](#)), click **Export**.

Basic users can only export the test result for the test currently displayed. For Basic users, the Result Export dialog box appears (see [Figure 5-58](#)). Locate and select the folder where the file is to be exported, type a file name, and then click **Save**.

Detail and Administrator users can select and export results for multiple tests at one time. Various options can also be selected for export. For Detail and Administrator users, the Export Data dialog box appears. See [Figure 5-57](#).

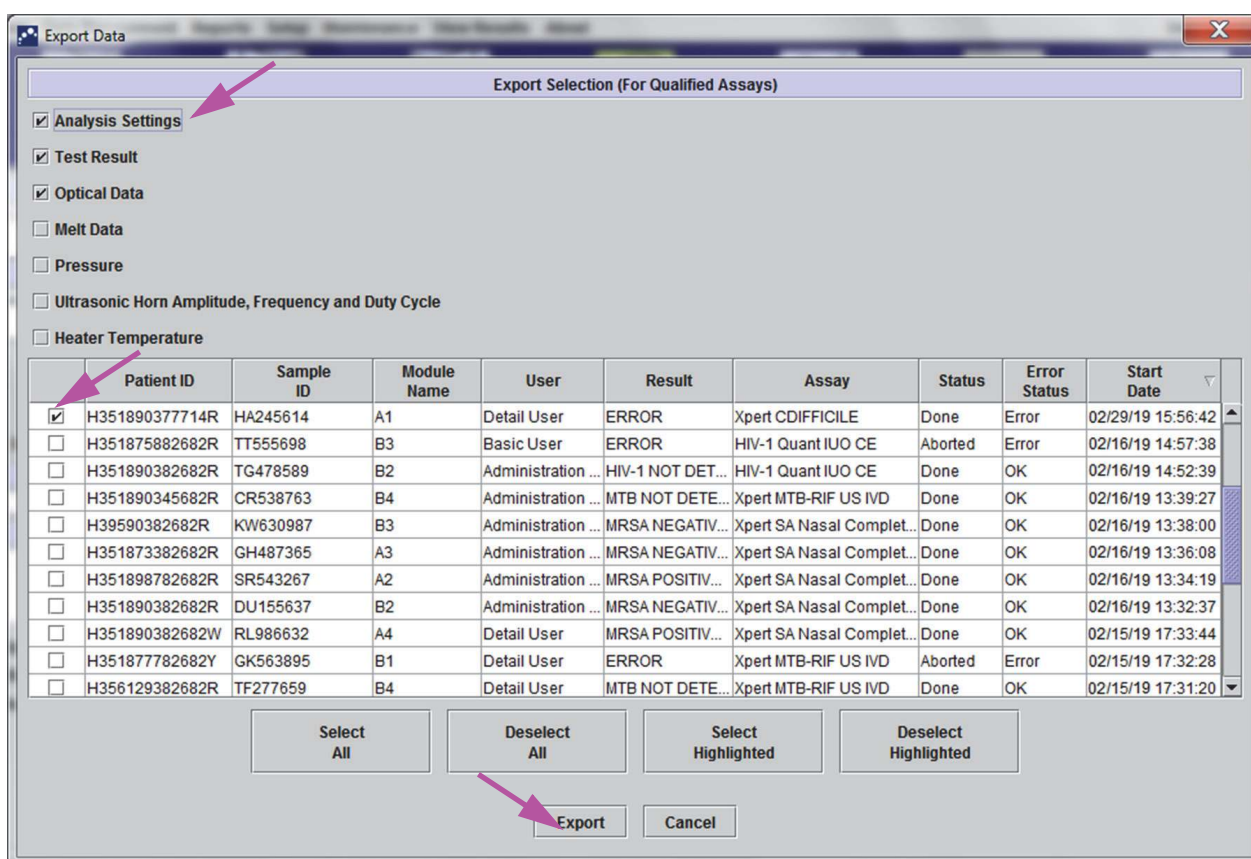

Figure 5-57. Export Data Dialog Box (Detail Users and Administrator Only)

In the upper left-hand corner of the dialog box, several types of information are available. Select the information you want to include in the export by clicking the check box(es) to the left of the item(s):

- **Analysis Settings**—Select to include analysis settings in the report.
- **Test Result**—Select to include the test result in the report.
- **Optical Data**—Select to include optical data in the report.
- **Melt Data**—Select to include melt data in the report.
- **Pressure**—Select to include pressure information in the report.
- **Ultrasonic Horn Amplitude, Frequency and Duty Cycle**—Select to include ultrasonic horn amplitude, frequency and duty cycle in the report.
- **Heater Temperature**—Select to include heater temperature information in the report.

Select the test results and the associated information you want to export. The four buttons at the bottom of the screen, **Select All**, **Deselect All**, **Select Highlighted** and **Deselect Highlighted** provide shortcuts to making selections. Click **Export** when you have made your selection. The Result Export dialog box appears (see Figure 5-58). Locate and select the folder where the file is to be exported, type a file name, and then click **Save**.

Note

The **export** folder is the default folder. When a report file is exported, the software will remember the last directory used.

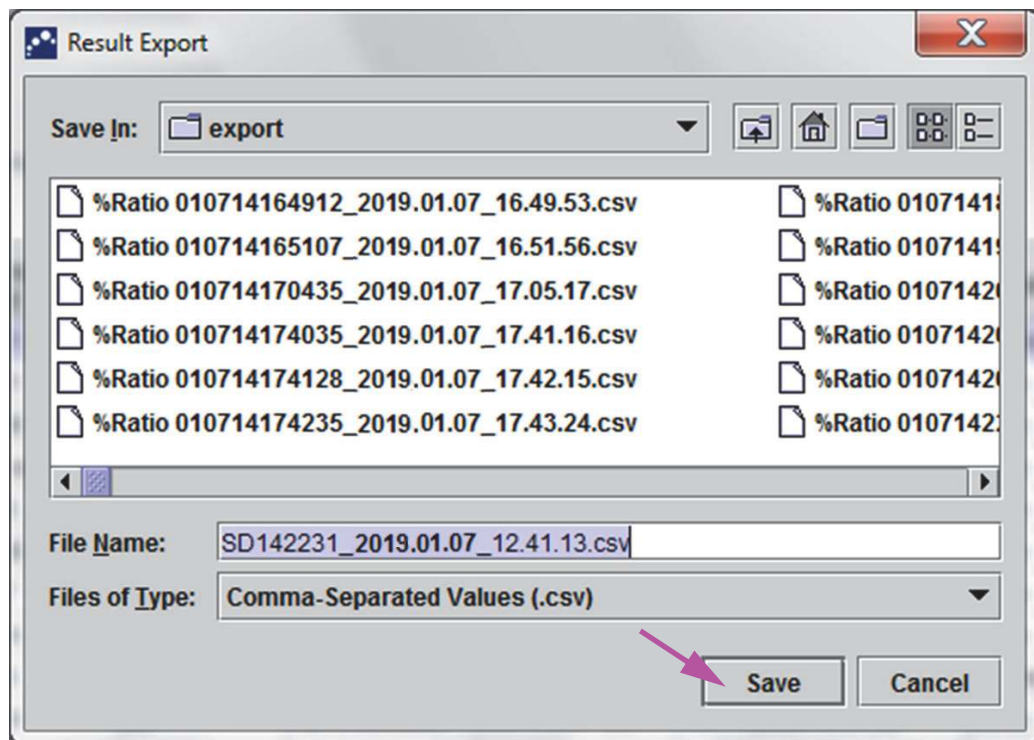

Figure 5-58. Result Export Dialog Box

Opening and Viewing a .csv File

The exported test results can be opened using Apache OpenOffice (AOO) or other software program that supports .csv files. The following instructions describe the use of AOO for opening and viewing a .csv file.

Refer to Appendix D for in-depth instructions for configuring Apache OpenOffice.

Note

GeneXpert Dx systems shipped prior to November 30, 2015 may have Microsoft Office installed, and .csv files can be opened and viewed using the Excel program available in that software suite as well.

1. In the GeneXpert folder on your system, navigate to the **Export** folder. Right click on the .csv file you want to open. When the drop-down menu appears, click **Open with** and select **OpenOffice Calc**. See [Figure 5-59](#).

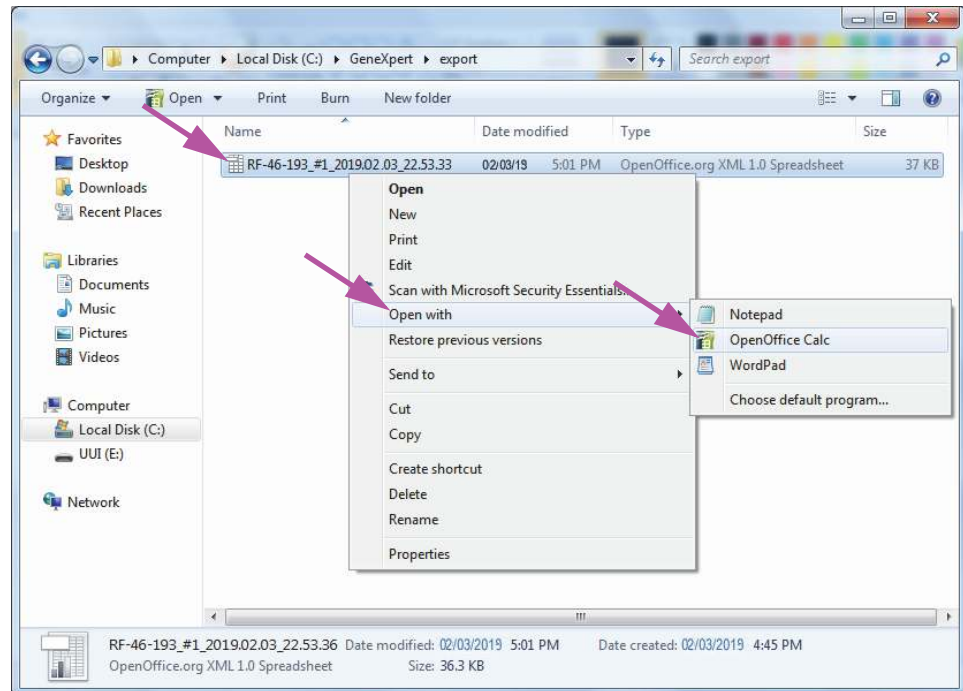

Figure 5-59. Opening a .csv File to Configure AOO (Example)

2. The Text Import screen will appear. On this screen, verify the checkboxes to the left of **Comma** and **Quoted field as text** have been checked. See [Figure 5-60](#).

In the **Character Set** drop-down menu:

For single-byte languages (English, French, Spanish, Portuguese, Italian, German, Russian) select **Unicode (UTF-8)**.

For multi-byte languages (Japanese and Chinese) select **Unicode**.

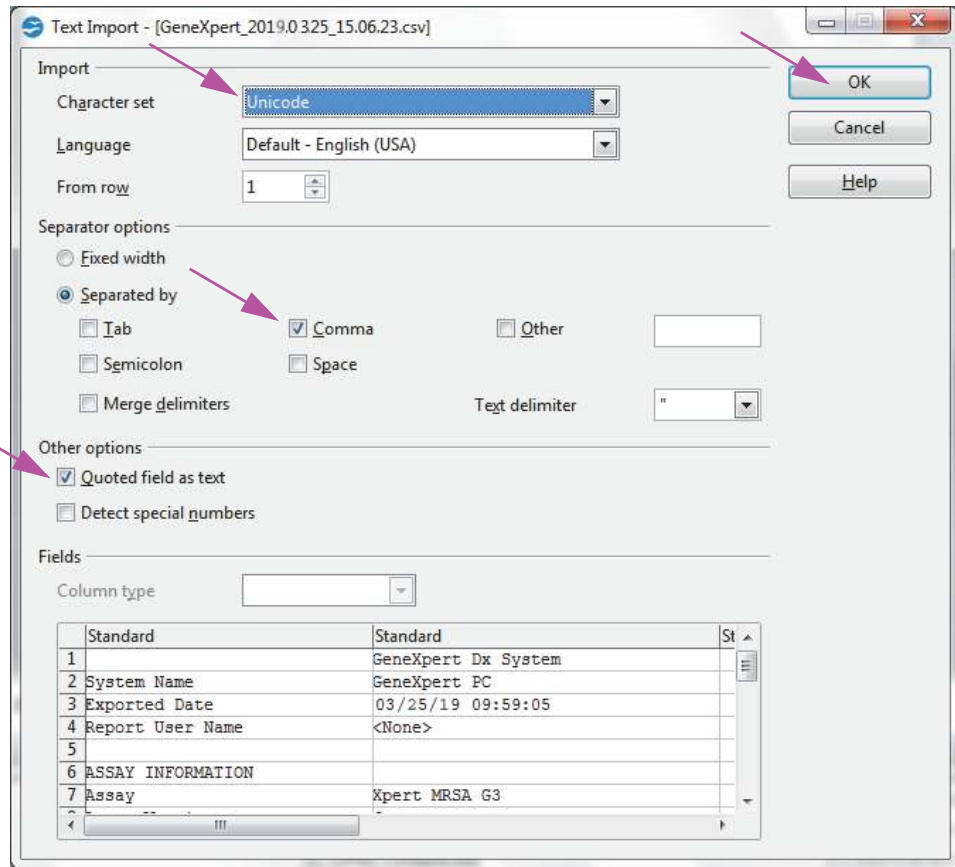

Figure 5-60. Text Import Screen with New Settings Selected

3. After verifying the Separator and other options, click **OK**. The .csv file will be displayed.
4. Once the file is open, click on the upper left corner of the worksheet to highlight all the cells, as shown in Figure 5-61.

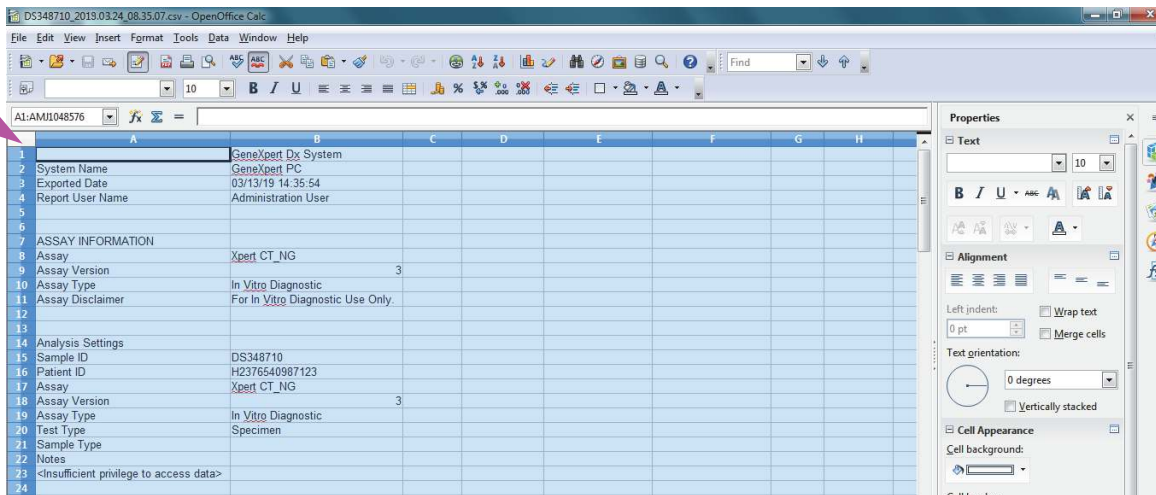

Figure 5-61. All Cells Selected

5. Right click on the column header. A drop-down menu will appear at the right of the column (see [Figure 5-62](#)).
6. In this drop-down menu, select **Column Width**.

Right-Click in Column Header

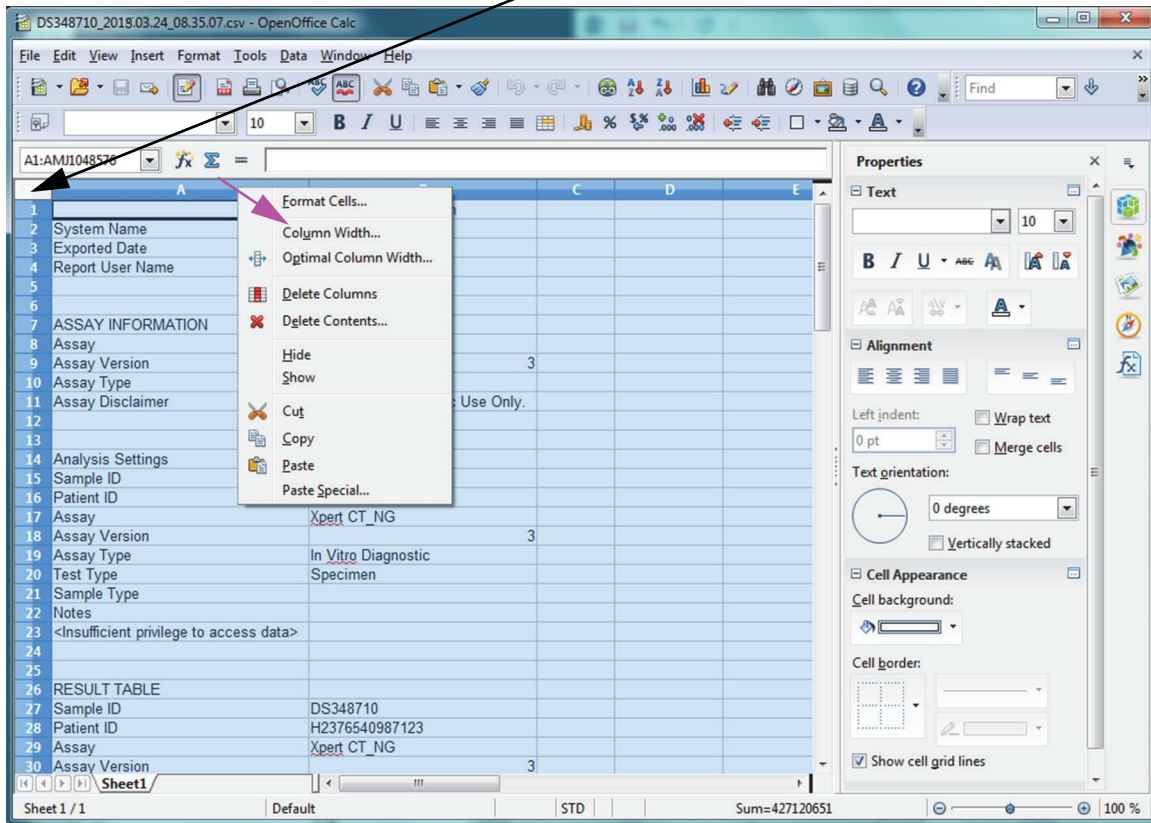

Figure 5-62. Drop-Down Menu to Select Column Width

7. The Column Width dialog box appears. See [Figure 5-63](#).

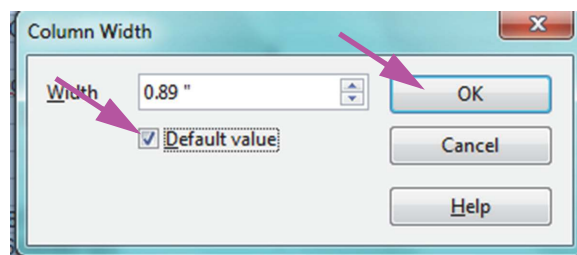

Figure 5-63. Column Width Dialog Box

8. Click the checkbox to the left of **Default value**, and then click **OK** to close the dialog box. The column widths will then adjust and the file will be formatted, as shown in [Figure 5-64](#). Click anywhere in the blank columns to “deselect” the blue cells and turn the cells white again.

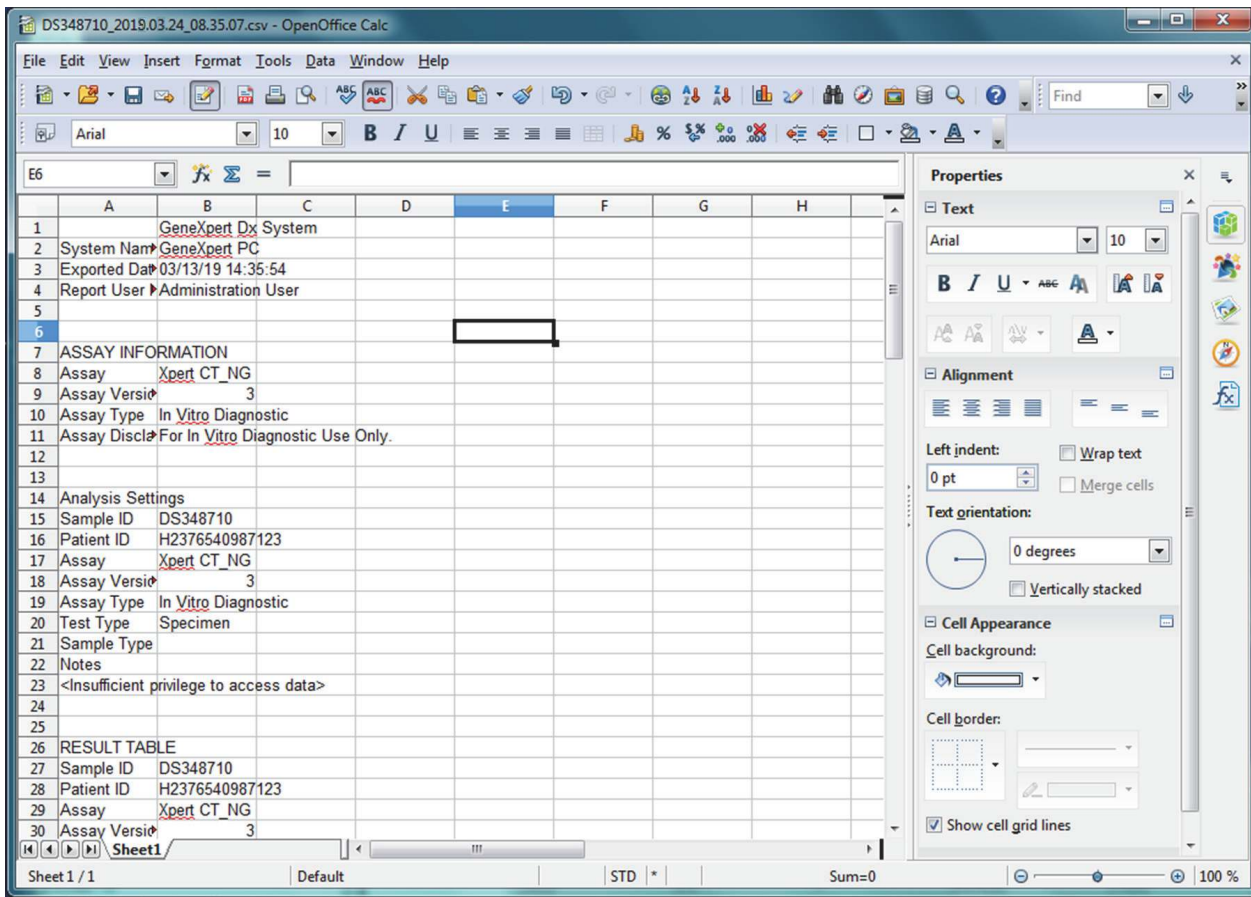

Figure 5-64. Example Exported Test Results

9. Click **Save** under the **File** menu to save the document.

5.15 Uploading Test Results to the Host

If your host connectivity is enabled, the **Upload Test** button (see Figure 5-65) is available for use to select test(s) for uploading to the host. For details, see Section 5.20, *Operating with Host Connectivity*.

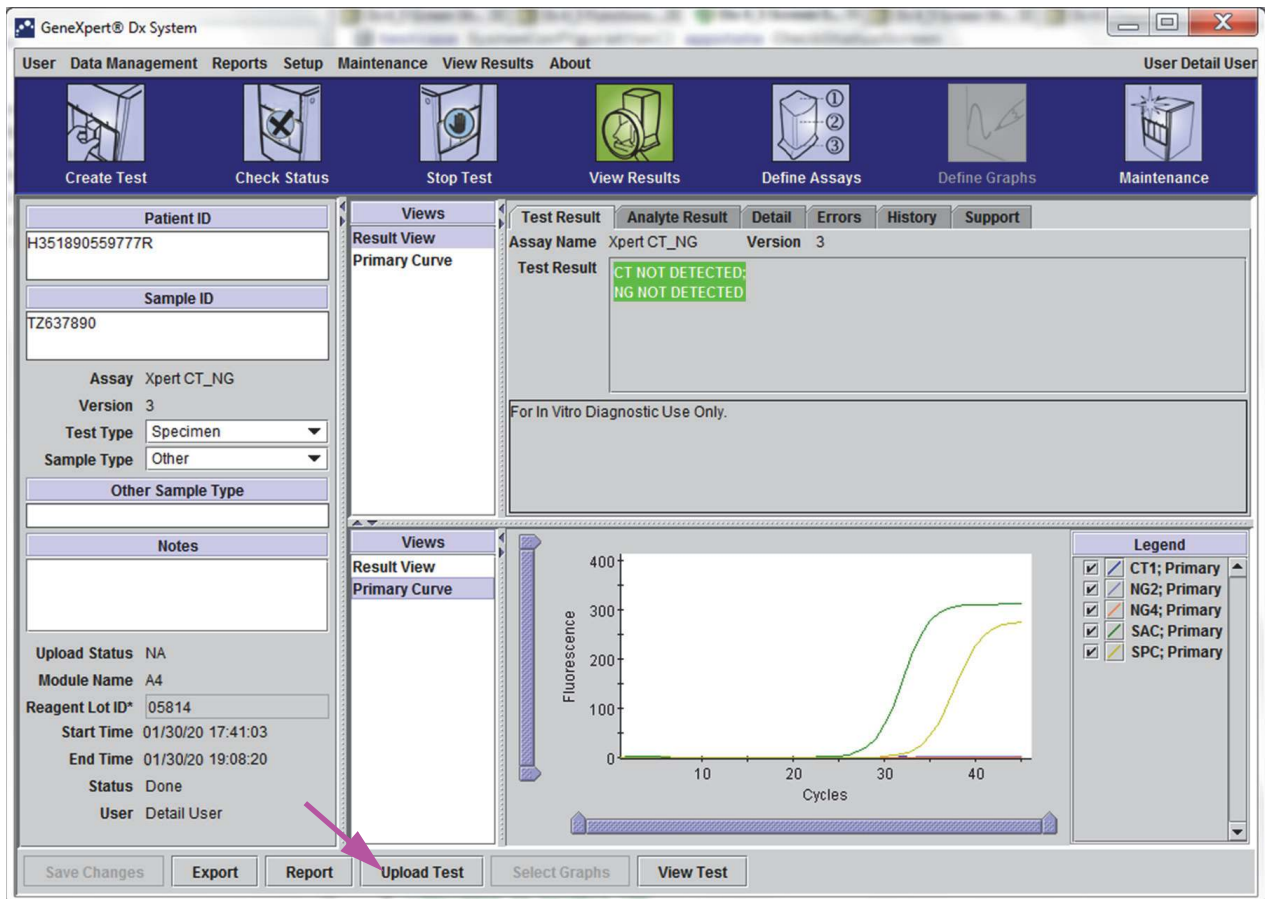

Figure 5-65. Upload Test Results to the Host

5.16 Managing the Test Results Data

The GeneXpert Dx system includes a database that stores all of the saved test results. You can:

- Manage the test result data:
 - Archive tests and then purge archived tests to save database space (see [Section 5.16.1, Archiving the Tests](#)).
 - Retrieve tests from an archived file (see [Section 5.16.2, Retrieving Data from an Archive File](#)).
- Perform database management tasks (only during system startup and shutdown):
 - Back up the database (see [Section 5.17.1, Backing up the Database](#)).
 - Restore the database (see [Section 5.17.2, Restoring the Database](#)).
 - Compact the database (see [Section 5.17.3, Compacting the Database](#)).

The GeneXpert Dx system administrator specifies whether you have the permissions for the data management tasks. See [Section 2.13, Defining Users and Permissions](#). See your GeneXpert Dx system administrator to adjust the permissions to meet your requirements.

5.16.1 Archiving the Tests

Archiving tests allows you to move your data and, if desired, free up space in the database. You can archive multiple tests at a time. In addition to serving as a safe-keeping mechanism, you can provide the archive files to Cepheid for analysis when troubleshooting. The archive process creates a copy of the test and saves the data in a .nxx file.

Important

Some e-mail filters may block files with .nxx extensions. Adjust your email filter, if possible, or change the extensions, if required.

To archive the test data:

1. In the GeneXpert Dx System window, on the **Data Management** menu, click **Archive Test**. The Select Test(s) To Be Archived dialog box appears. See [Figure 5-66](#).

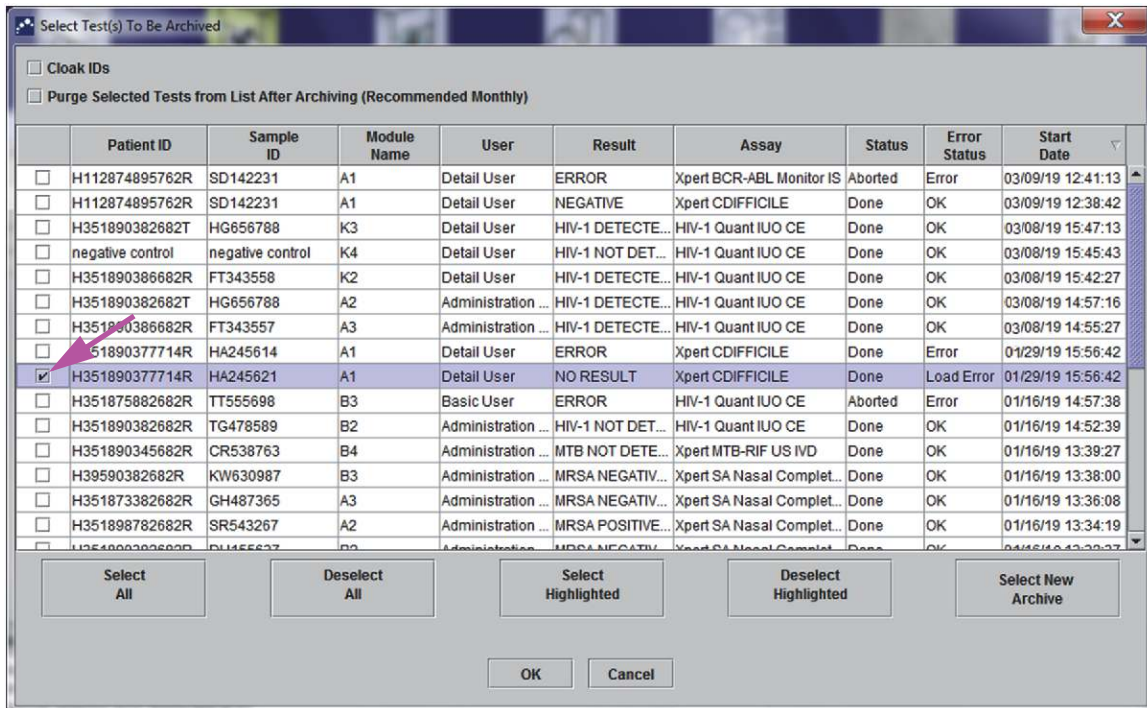

Figure 5-66. Select Test(s) To Be Archived Dialog Box

2. Select the test(s) you want to archive. Click the check box that is adjacent to each test you want to archive. See Figure 5-66. You can select the individual tests one-by-one, or select a large number of tests by clicking one of the following buttons at the bottom of the Select Tests To Be Archived screen:
 - **Select All**—Selects all of the tests in the table.
 - **Select Highlighted**—Selects the tests you highlighted.
 - **Select New Archive**—Selects only the tests that have not been archived before.

Note

You can also hold the **Shift** or **Ctrl** keys to highlight continuous and discontinuous multiple tests on the Select Tests To Be Archived screen.

After selecting tests on the Select Tests To Be Archived screen, click one of the following buttons to deselect some or all tests:

- **Deselect All**—Deselects all of the test selections in the window.
- **Deselect Highlighted**—Deselects the tests you highlighted.

In addition to selecting the tests to archive, there are two check boxes located near the top of the Select Tests To Be Archived screen that may need to be selected:

- **Cloak IDs and Notes**—Select this check box if you want to send Cepheid Technical Support some data in question, but want to hide patient-sensitive information. See [Masking Patient and Sample IDs During Test Archive](#) (below) for more information.

- **Purge Selected Tests from List After Archiving (Recommended monthly)**—Select this check box to free up space on the computer. After the selected tests have been successfully archived, they are removed from the database.
3. Click **OK**. A message appears and asks you to confirm the archive request.
 4. Click **Proceed**. The Save dialog box appears.
Click **Cancel** to not perform the Archive Test operation.
 5. Locate and select the folder in which you want to store the archive (.gxx/.nxx) file, type a name for the archive file, and then click **Save**.

Caution



The default archive location is the export folder which is located on the computer hard drive. To guard against loss of data, the files in the export folder should be periodically copied to a different computer or server. If the GeneXpert Dx system is connected to a network, it is possible to archive files directly to a server. To configure the archive location, see [Section 2.14.2, Archive Settings Tab](#).

6. After the files have been archived, the Archive Test(s) dialog box is displayed indicating that the tests have been successfully archived. Click **OK**.
7. If you selected the **Purge Selected Tests from List After Archiving (Recommended Monthly)** option, a Purge Test(s) dialog box appears indicating that the selected test(s) will be deleted from the database. Click **Yes** to confirm or click **No** to not delete the selected test(s) from the database.

Caution



If data is archived and purged from the database, then the archive files will only include the Patient ID and not the patient demographic data. Therefore, it will not be available again and cannot be used in future connectivity solutions.

Important

It is important to understand that when tests have been archived, they have not been permanently deleted from the computer. They have been removed from the main system database and saved to an archive file when the **Purge Selected Tests from List After Archiving (Recommended Monthly)** option has been selected. Tests may be retrieved from the archive file if needed for later use. See [Section 5.16.2, Retrieving Data from an Archive File](#).

Masking Patient and Sample IDs During Test Archive

Masking sample and Patient IDs allow customers to send Cepheid Technical Support some data in question, but hides patient-sensitive information.

When the **Cloak IDs** check box, located in the top left area of the Select Test(s) To Be Archived dialog box, (see [Figure 5-66](#)) is checked, all information about the sample ID and patient ID is masked.

Caution



Once you mask sample and or patient ID information for an archived test, if you retrieve the test information, the sample and patient ID information will still be masked. You should maintain an on-site copy of the archived test information without the masked information.

5.16.2 Retrieving Data from an Archive File

Caution



If a test you are retrieving already exists in the current database, the software will overwrite it and existing data will be lost.

You can retrieve test data from an archived file. To do this:

1. In the GeneXpert Dx System window, on the **Data Management** menu, click **Retrieve Test**. The Open dialog box appears.
2. Locate and select the archive (.gxx/.nxx) file, and then click **Open** to retrieve the selected test(s) from the old or new archive files.

If there are tests in the archive that already exist in the database, the Retrieve Test(s) dialog box will be displayed indicating the number of duplicate tests. Click **OK**.

3. The Select Test(s) To Be Retrieved From dialog box appears (see Figure 5-67). The tests that already exist in the current database appear in red text. Click **Cancel** in the Open dialog box to not retrieve any archived tests.

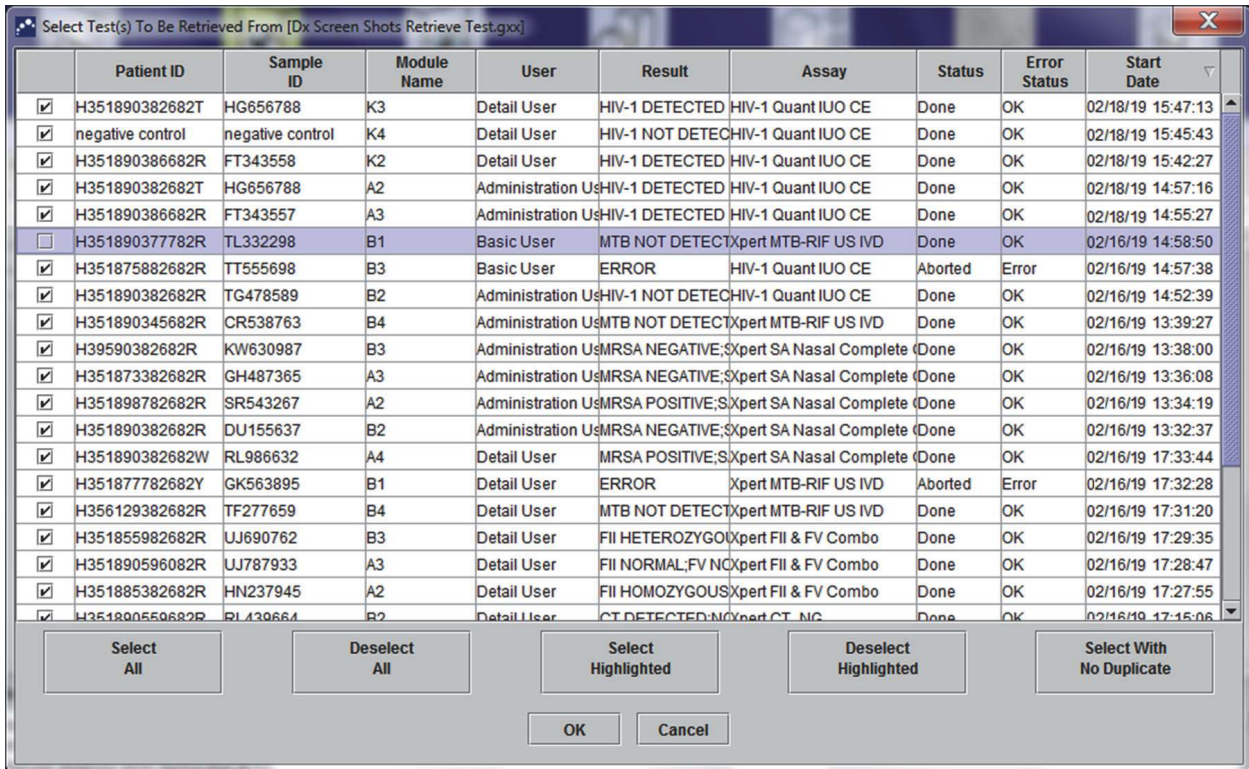

Figure 5-67. Select Test(s) to Be Retrieved Dialog Box

4. Select the tests you want to retrieve. You can select the individual tests one-by-one, or select multiple tests by clicking one of the following:
 - **Select All**—Selects all of the tests in the table.
 - **Select Highlighted**—Selects the tests you highlighted.
 - **Select With No Duplicate**—Selects only the tests that do not exist in the current database.
 - After selecting tests in the Select Tests to Retrieved From dialog box, click one of the following buttons to deselect some or all tests:
 - Click **Deselect All** to clear all of the selections in the dialog box.
 - Click **Deselect Highlighted** to clear the tests you highlighted.
5. Click **OK** to retrieve the selected test(s). The Retrieve Test(s) dialog box appears and asks you to confirm the retrieval.
Click **Cancel** to not retrieve the selected test(s) from the database.
6. In the Retrieve Test(s) dialog box, click **Proceed**. The selected test(s) are retrieved and a message appears and confirms that the tests are retrieved.
7. In the Retrieve Test(s) confirmation dialog box, click **OK**.

5.17 Performing Database Management Tasks

The database management tasks can only be performed during system startup and shutdown.

- Back up the database (see [Section 5.17.1, Backing up the Database](#)).
- Restore the database (see [Section 5.17.2, Restoring the Database](#)).
- Compact the database (see [Section 5.17.3, Compacting the Database](#)).

The GeneXpert Dx system administrator specifies whether you have permission for the data management tasks. See [Section 2.13, Defining Users and Permissions](#). See the GeneXpert Dx system administrator to adjust the permissions to meet your requirements. If **Database Management Reminders** are enabled, the user is prompted on startup whether to perform database management. The prompt appears only if the user has privileges to perform these tasks. If the user does not have any of these privileges or if **Database Management Reminders** are disabled, the prompt will not be displayed. See [Figure 5-68](#).

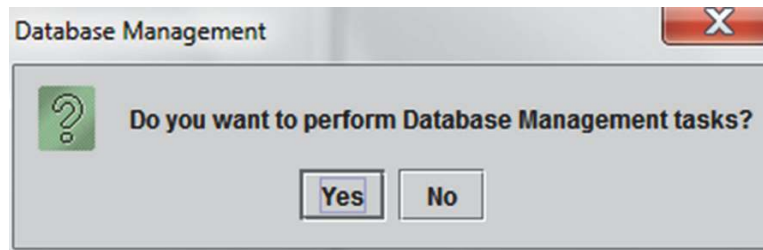

Figure 5-68. Database Management Dialog Box

8. **If you do not want to perform database management tasks**, click **No** in the Database Management dialog box (see [Figure 5-68](#)), and skip to [Section 5.2.3.2, Archive Overdue Reminder](#).

If you want to perform database management tasks, click **Yes** in the Database Management dialog box (see [Figure 5-68](#)). The Database Management window appears. See [Figure 5-69](#).

5.17.1 Backing up the Database

You should back up the entire database periodically and store the backup on a different computer or on a different storage medium. If the computer fails, you can restore the entire database using the backup copy.

To back up the database:

1. Select **Database Backup** on the Database Management window (see [Figure 5-69](#)).
2. Click **Proceed**.

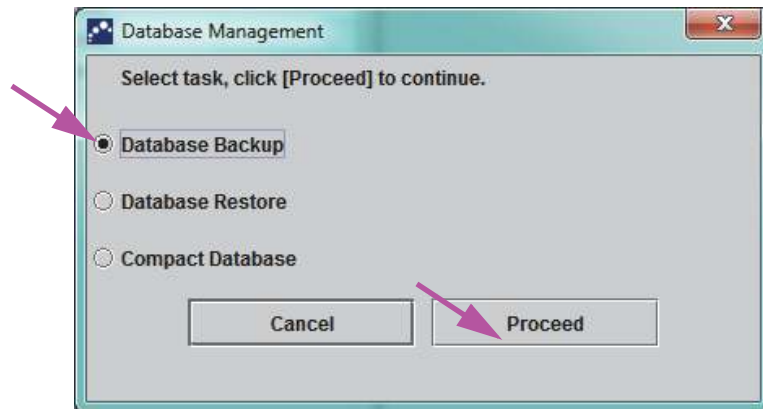

Figure 5-69. Database Management Window

3. Locate and select the folder in which you want to store the backup file, type a name for the backup file (or use the default file name), and then click **Save**. The backup process creates a .zip file in the location you specified (see [Figure 5-70](#)).

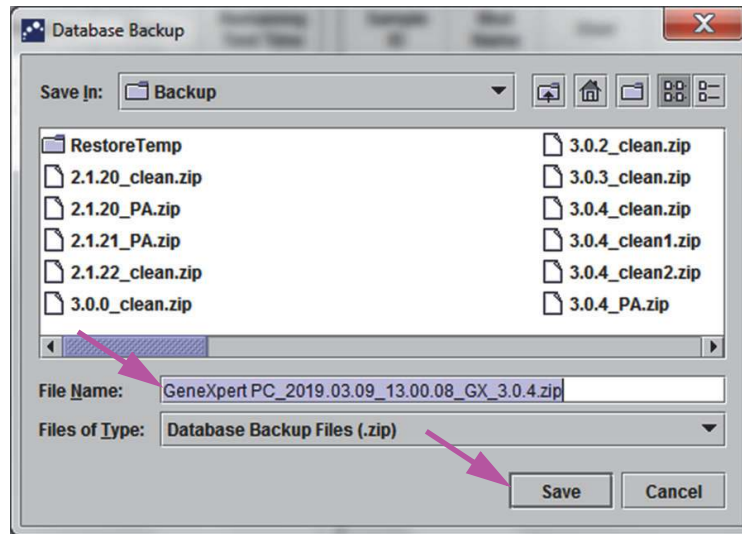

Figure 5-70. Backup File Naming

4. The backup process varies, depending on the amount of data in the database and the speed of the computer (older computers may take longer).

Note

It has been found that 1000 tests takes less than 30 seconds, and 3000 tests takes less than a minute.

For large database backups, a progress bar will be displayed. When the backup process is finished, a process completion message appears (see [Figure 5-71](#)).

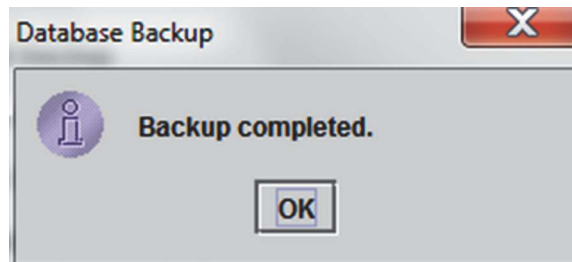

Figure 5-71. Backup Completed Screen

Caution



The default database backup location is the Backup folder which is located on the computer hard drive. To guard against loss of data, the files in the Backup folder should be periodically copied to a different computer or server. If the GeneXpert Dx system is connected to a network, it is possible to back up the files directly to a server. To configure the database backup location, see [Section 2.14.3, Folders Tab](#).

5.17.2 Restoring the Database

Caution



The database restore process overwrites the data in the current database. Do not restore a database unless the current database is corrupted or needs to be replaced.

Note

If you are running C360 Sync on your system, verify that Cepheid Reporter Daemon has stopped before restoring the GeneXpert database. See **Reporting a GeneXpert Database** under the **Tests** tab in the *C360 Sync Quick Reference Guide* for details instructions about how to stop the Cepheid Reporter Daemon.

You can restore the entire database using the backup database file. Because the restore process overwrites the data in the current database, first archive any test data to be retained (see [Section 5.16.1, Archiving the Tests](#)), restore the database, and then retrieve the data from the archive file (see [Section 5.16.2, Retrieving Data from an Archive File](#)).

To restore the database:

1. Select **Database Restore** on the Database Management window. See [Figure 5-72](#).

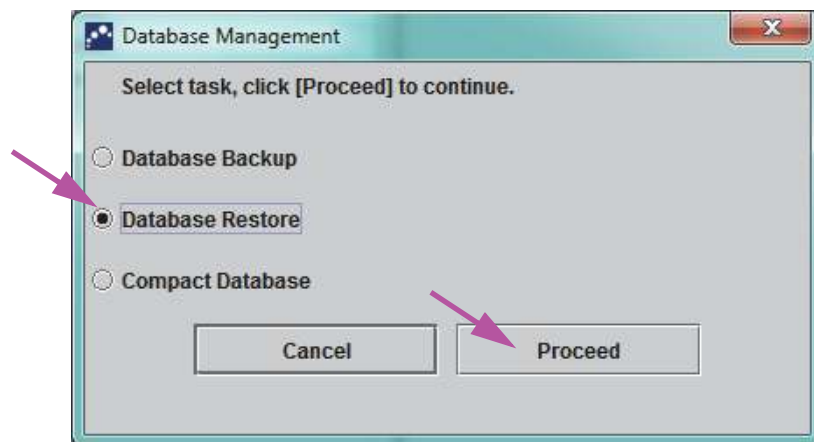

Figure 5-72. Database Management Window

2. Click **Proceed**. A dialog box appears asking if you want to back up the current database (recommended) before restoring. See [Figure 5-73](#).

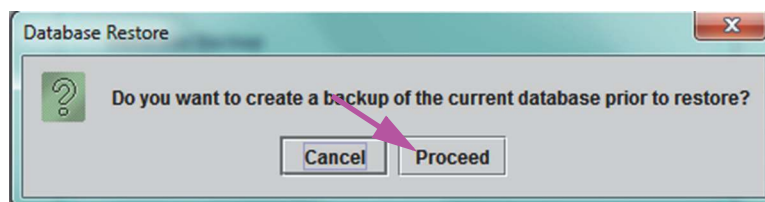

Figure 5-73. Database Restore Dialog Box

3. Click **Proceed** in the Database Restore confirmation dialog box to continue with the database backup (see [Figure 5-73](#)). The Database Backup dialog will be displayed. See [Figure 5-74](#).

Click **Cancel** to not back up the database and proceed directly to the Select File To Restore the Database screen (see [Figure 5-76](#)).

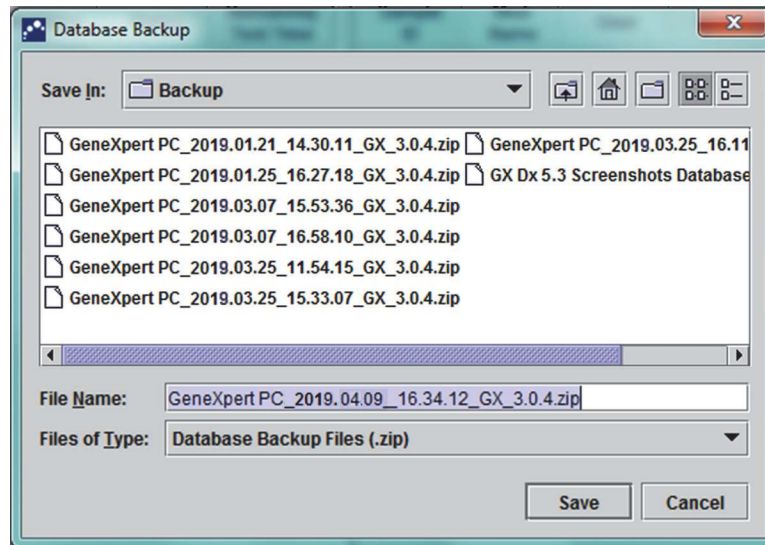

Figure 5-74. Database Backup Dialog Box

4. Locate and select the folder in which you want to store the backup file, type a name for the backup file (or use the default filename) and click **Save**. See [Figure 5-74](#).
5. The database will be backed up to the selected location. The Backup process time varies, depending on the amount of data in the database and the speed of the computer (older computers may take longer).

Note

It has been found that 1000 tests takes less than 30 seconds, and 3000 tests takes less than a minute.

For large database backups, a progress bar will be displayed. The Backup completed screen appears when the database backup is complete. See [Figure 5-75](#).

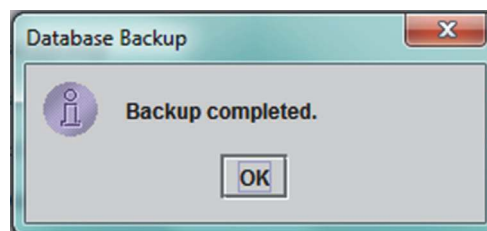

Figure 5-75. Backup Completed Screen

6. Click **OK**. The Select File to Restore the Database screen appears. See [Figure 5-76](#).

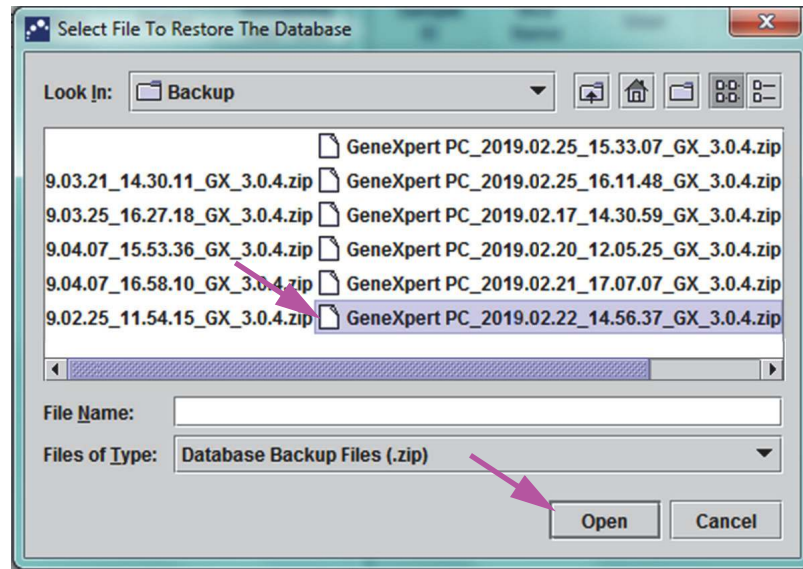

Figure 5-76. Select File to Restore the Database Screen, with Filename

7. Select the file to restore, and then click the **Open** button.
8. The Database Restore confirmation dialog box appears. See [Figure 5-77](#).

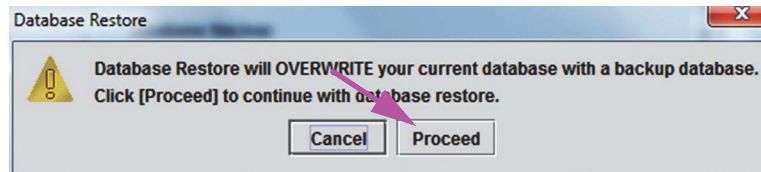

Figure 5-77. Database Restore Confirmation Dialog Box

9. Either click **Proceed** in the Database Restore confirmation dialog box to continue, or click **Cancel** to discontinue and return to the Database Management screen (see [Figure 5-72](#)).
10. If you clicked **Proceed**, the restore process will begin. The restore process time varies, depending on the amount of data in the database and the speed of the computer (older computers may take longer).

Note

It has been found that 1000 tests takes less than 30 seconds, and 3000 tests takes less than a minute.

For large database restores, a progress bar will be displayed. When the restoration process is finished, a process completion message appears (see [Figure 5-78](#)).

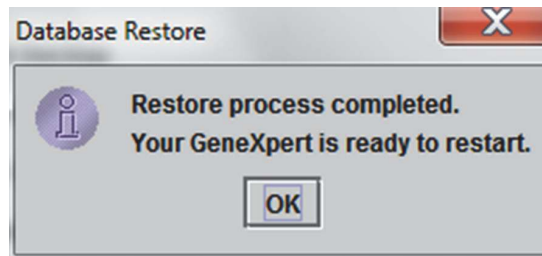

Figure 5-78. Database Restore Completed Confirmation Screen

11. Click **OK** to close the GeneXpert Dx software application.
12. If desired, restart the GeneXpert Dx software. For details on starting the software, see [Section 5.2.3, Starting the Software](#).

5.17.3 Compacting the Database

Compact the database periodically to ensure efficient use of the space in the database and to save hard disk space.

To compact the database:

1. Select **Compact Database** on the Database Management window. See [Figure 5-72](#).
2. Click **Proceed** on the Database Management window. The Compact Database confirmation dialog box appears. See [Figure 5-79](#).

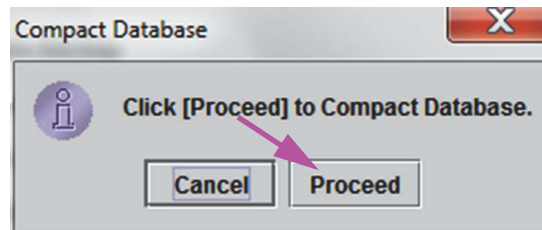

Figure 5-79. Compact Database Confirmation Dialog Box

3. Click **Proceed** to compact the database. When the database compacting has completed, the Compact Database complete dialog box will appear. See [Figure 5-80](#).

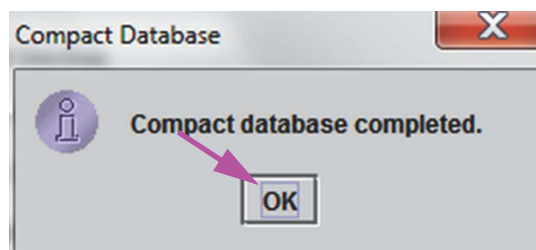

Figure 5-80. Compact Database Completed Dialog Box

4. Click **OK**.

Note

In addition to compacting the database, you can also save space by purging tests from the database after archiving. For details on deleting archived tests, see [Section 5.16.1, Archiving the Tests](#).

5. Click **Cancel** to close the Database Management window.

5.18 Purging Tests from the Database

Tests may be purged from the active database after they have been archived (see [Section 5.16.1, Archiving the Tests](#) for details).

Important

When tests have been archived, they have not been permanently deleted from the computer. They have been removed from the main system database and saved to an archive file when the Purge Selected Tests from List After Archiving (Recommended Monthly) option has been selected. Tests may be retrieved from the archive file if needed for later use. See [Section 5.16.2, Retrieving Data from an Archive File](#).

5.19 Viewing and Printing Reports

Important

To ensure all data is displayed correctly, reports must be generated in the same language that was used when the test results were collected.

The **Reports** menu (see [Figure 5-81](#)) provides the following menu options:

- **Specimen Report** (see [Section 5.19.1](#))
- **Patient Report** (see [Section 5.19.2](#))
- **Control Trend Report** (see [Section 5.19.3](#))
- **System Log** (see [Section 5.19.4](#))
- **Assay Statistics Report** (see [Section 5.19.5](#))
- **Installation Qualification** (see [Section 5.19.6](#))

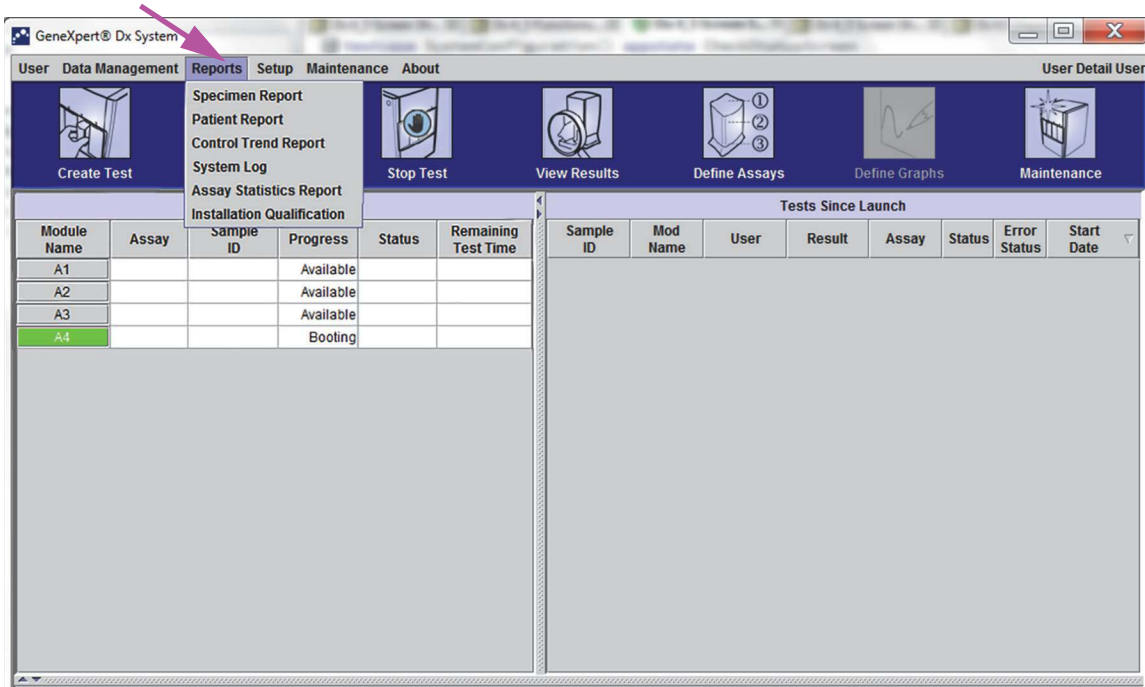

Figure 5-81. GeneXpert Dx System Window—Reports Drop-Down Menu

5.19.1 Specimen Report

The Specimen Report provides an overview of the test results for the selected specimen in the database. This menu item is available to all users unless it has been restricted by the system administrator.

To view the specimen report:

1. In the GeneXpert Dx System window, on the **Reports** menu (see [Figure 5-81](#)), click **Specimen Report**. The Specimen Report dialog box appears. See [Figure 5-82](#).
2. Specify the following criteria to view the specimen report of interest:
 - **Date Range**—Click **All** to view all dates or click **Select** to view report(s) for a specific date range.
 - **Sample ID**—You can enter the exact sample ID, a single-character wildcard combined in exact characters or a multiple-character wildcard (%) with or without exact characters.

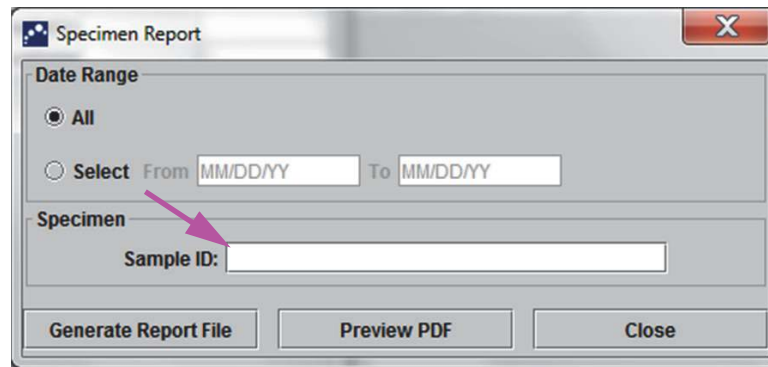

Figure 5-82. Specimen Report Dialog Box

3. When the criteria selection has been completed, click one of the following buttons:
 - A. **Generate Report File**—Creates a PDF file and saves it to the location you specify.
 - 1) Click the **Generate Report File** button on the Specimen Report screen (see [Figure 5-82](#)) to create the PDF file of the report. The Generate Report File dialog box will appear, which enables you to save the file to a specified location. Click **Save** once you have navigated to the specific location.
 - 2) Optionally, to print the report, go to the saved location, open the test report and print it. A test report similar to the report shown in [Figure 5-83](#) will be printed.
 - B. **Preview PDF**—Creates a PDF file and displays the file in the Adobe Reader window. See [Figure 5-83](#). You can save and print the PDF file from the Adobe Reader software.
4. After selecting one of the two buttons in [Step 3](#), a Specimen Report dialog box will be displayed indicating the number of matching Sample IDs found. Click **OK**. The Specimen Report will be created in the specified format.
5. After generating the Specimen Report, click **Close** to close the Specimen Report dialog box.

GeneXpert PC 02/17/20 12:55:54

Specimen Report

Found Sample ID #2 = DU155637

- 1 Test(s) Found -

Patient ID: H351890382682R
Sample ID: DU155637
Assay: Xpert SA Nasal Complete G3
Assay Version: 5
Test Result: **MRSA NEGATIVE;**
SA POSITIVE
Start Time: 02/16/20 13:32:37
Test Type: Specimen
User: Administration User
Status: Done
Notes:

GeneXpert® Dx System Version 6.2 Page 1 of 31

Figure 5-83. Example Specimen Report

5.19.2 Patient Report (If Enabled)

The Patient Report provides test results for samples for one patient according to the Patient ID in the database. This menu item is available to all users unless it has been restricted by the system administrator.

To view the patient report:

1. In the GeneXpert Dx System window, on the **Reports** menu (see [Figure 5-81](#)), click **Patient Report**. The Patient Report dialog box appears. See [Figure 5-84](#).

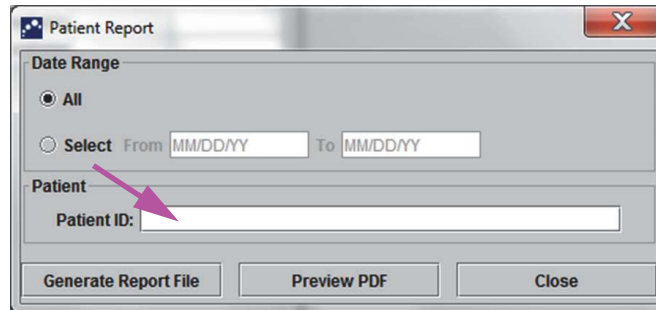

Figure 5-84. Patient Report Dialog Box

2. Specify the following criteria to view the patient report of interest:
 - **Date Range**—Click **All** to view all reports or click **Select** to view report(s) for a specific date range.
 - **Patient ID**—the user can enter the exact patient ID, a single-character wildcard _ combined in exact characters or a multiple-character wildcard (%) with or without exact characters.
3. When you finish selecting the criteria, click one of the following buttons:
 - A. **Generate Report File**—Creates a PDF file and saves it to the specified location.
 - 1) Click the **GENERATE REPORT FILE** button on Patient Report screen (see [Figure 5-84](#)) to create the PDF file of the report. The Generate Report File dialog box will appear, which enables you to save the file to a specified location. Click **Save** once you have navigated to the specific location.
 - 2) Optionally, to print the report, go to the saved location, open the test report and print it. A test report similar to the report shown in [Figure 5-85](#) will be printed.
 - B. **Preview PDF**—Creates a PDF file and displays the file in the Adobe Reader window. See [Figure 5-85](#). You can save and print the PDF file from the Adobe Reader software.
4. After selecting one of the two buttons in [Step 3](#), a Patient Report dialog box will be displayed indicating the number of matching Patient IDs found. Click **OK**. The Patient Report will be created in the specified format.
5. After generating the Patient Report, click **Close** to close the Patient Report dialog box.

GeneXpert PC 02/09/20 12:51:40

Patient Report

Found Patient ID #2 = H112874895762R

- 2 Test(s) Found -

Patient ID: H112874895762R
Sample ID: SD142231
Assay: Xpert CDIFFICILE
Assay Version: 3
Test Result: **NEGATIVE**
Start Time: 02/09/20 12:38:42
Test Type: Specimen
User: Detail User
Status: Done
Notes:

Patient ID: H112874895762R
Sample ID: SD142231
Assay: Xpert BCR-ABL Monitor IS
Assay Version: 1
Test Result: **ERROR**
Start Time: 02/09/20 12:41:13
Test Type: Specimen
User: Detail User
Status: Aborted
Notes:

GeneXpert® Dx System Version 6.2 Page 1 of 23

Figure 5-85. Example Patient Report

5.19.3 Control Trend Report

See [Section 6.5, Control Trend Reports](#).

5.19.4 System Log

See [Section 9.16, Generating the System Log Report](#).

5.19.5 Assay Statistics Report

An Assay Statistics Report is a report showing the number of tests performed for each assay over a period of time with monthly breakdown values. This menu item is available to Detail and Administrator users unless it has been restricted by the system administrator.

To view the assay statistics report:

1. In the GeneXpert Dx System window, on the **Reports** menu (see [Figure 5-81](#)), click **Assay Statistics Report**. The Assay Statistics Report dialog box appears. See [Figure 5-86](#).

Assay Statistics Report

Date Range

Last 12 Months

Select From To

Assay

All

Select

Select	Assay	Version
<input type="checkbox"/>	Xpert BCR-ABL Monitor IS	1
<input checked="" type="checkbox"/>	Xpert CDIFFICILE	3
<input type="checkbox"/>	Xpert Flu A Panel	3

Generate Report File Preview PDF Close

Figure 5-86. Assay Statistics Report Dialog Box

2. Specify the following criteria to view the assay statistics of interest:
 - **Date Range**—Select **Last 12 Months** or **Select** for a specific date range.
 - **Assay**—Select **All** to select all the listed assays or **Select** to select a specific assay.
3. When you finish selecting the assay(s), click one or both of the following buttons:
 - **Generate Report File**—Creates a PDF file and saves it to the location you specify.
 - 1) Click the **Generate Report File** button on the Assay Statistics Report screen (see [Figure 5-86](#)) to create the PDF file of the report. The Generate Report File dialog box will appear, which enables you to save the file to a specified location. Click **Save** once you have navigated to the specific location.
 - 2) Optionally, to print the report, go to the saved location, open the report and print it. A report similar to the report shown in [Figure 5-87](#) will be printed.
 - **Preview PDF**—Creates a PDF file and displays the file in the Adobe Reader window. See [Figure 5-87](#). You can save and print the PDF file from the Adobe Reader software.
4. After selecting one of the two buttons in [Step 3](#), an Assay Statistics Report dialog box will be displayed indicating the number of matching assays found. Click **OK**. The Assay Statistics Report will be created in the specified format.
 - After generating the Assay Statistics Report, click **Close** to close the Assay Statistics dialog box.
 - **Preview PDF**—Creates a PDF file and displays the file in the Adobe Reader window. See [Figure 5-87](#). You can save and print the PDF file from the Adobe Reader software.

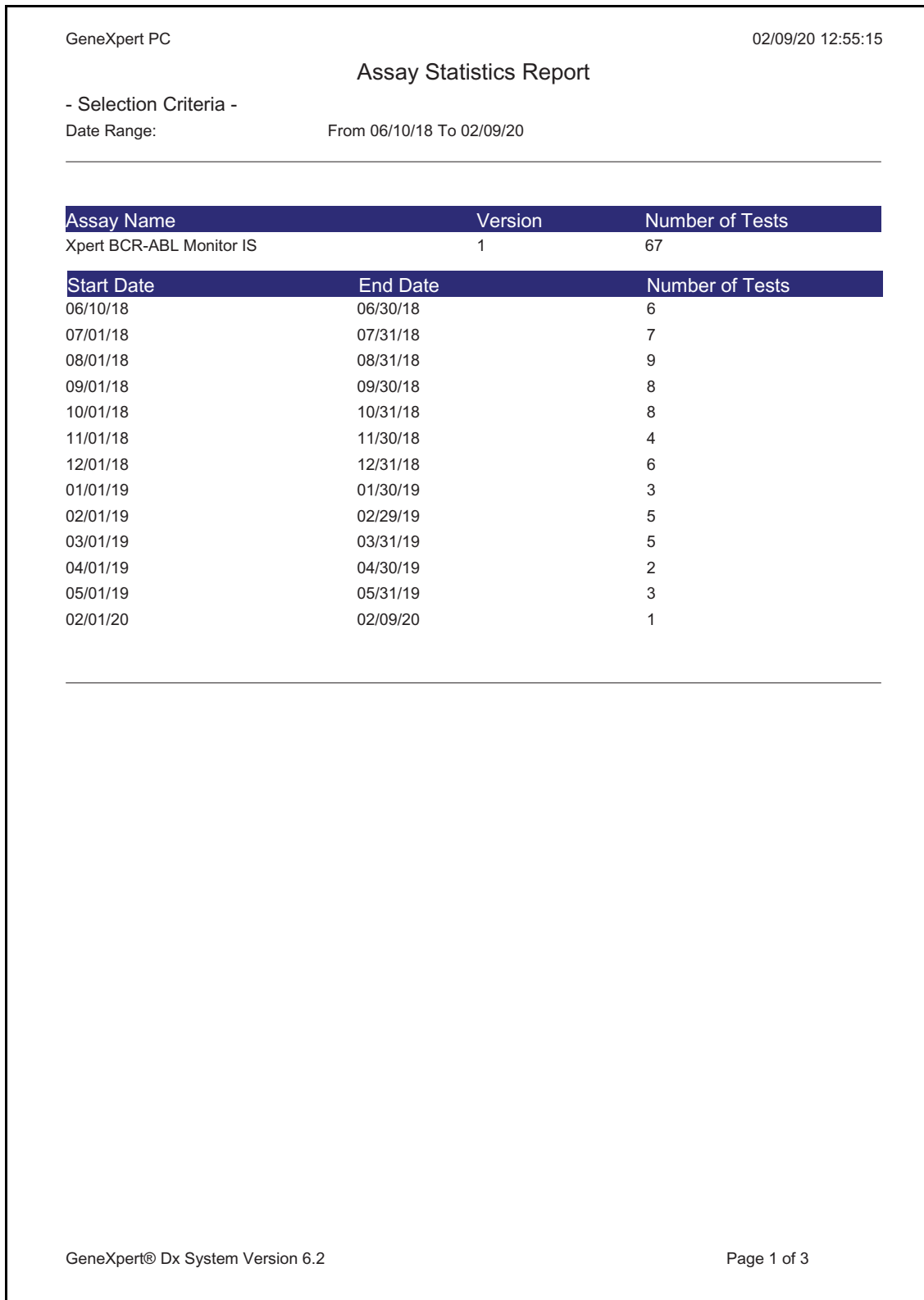

Figure 5-87. Example Assay Statistics Report

5.19.6 Installation Qualification

See [Section 2.15, Verifying Proper Installation and Setup](#).

5.20 Operating with Host Connectivity

This section provides instructions on how to use the GeneXpert Dx host interface to:

- Configure Assay for order and result upload ([Section 5.20.1, Creating a Test with Host Connectivity](#))
- Create a test from downloaded test order ([Section 5.20.1, Creating a Test with Host Connectivity](#))
- Upload a test result ([Section 5.20.2, Uploading a Test Result to the Host](#))
- Troubleshoot Host Connectivity ([Section 5.20.3, Troubleshooting Host Connectivity](#))

Caution



Cepheid recommends to always confirm that LIS uploaded results match GeneXpert Dx system test results after any changes to the GeneXpert Dx system or host system, including (but not limited to) changes to the following:

- GeneXpert Dx software version
 - GeneXpert Assay Definition version
 - GeneXpert Dx Host Communication Settings
 - Host middleware software or configuration changes
 - LIS software or configuration changes
-

5.20.1 Creating a Test with Host Connectivity

When the host connectivity is enabled, test orders can be automatically downloaded from the host by:

- The GeneXpert Dx system periodically requesting new orders
- Manual queries by GeneXpert Dx system user of new orders from the Create Test dialog box
- Scanning or entering the Sample ID to perform host query for orders for a specific Sample ID

The workflow in your laboratory will determine how a test is created.

Additional areas are available in Create Test dialog box. See [Figure 5-88](#).

The screenshot shows the 'Create Test' window. At the top is a 'Host Test Order Table' with the following data:

Patient ID	Sample ID	Assay	STAT	Host Order Time	
Patient ID 1	Sample ID 1	Xpert EV Assay Version 3	Normal	02/16/20 16:29:28	Delete

Below the table is a 'Delete All Host Test Orders' button. To the right of a scrollable area is a 'Manual Query' button, which is highlighted with a pink arrow. Below these are input fields for Patient ID, Sample ID, Select Assay (set to '<None>'), Select Module, Reagent Lot ID, Expiration Date (YYYY/MM/DD), Cartridge S/N, Test Type (Specimen), Sample Type, and Other Sample Type. A Notes text area is also present. At the bottom are 'Start Test', 'Scan Cartridge Barcode', and 'Cancel' buttons.

Figure 5-88. Create Test Window with Host Test Order Table

- **Host Test Order Table**—New orders are shown in the table which can be sorted by clicking the header. The table contains:
 - **Patient ID**—Patient ID (s) for each test order.
 - **Sample ID**—Sample ID (s) for each test order.
 - **Assay**—Assay name and version number for each test order.
 - **STAT**—Indicates whether it is **STAT** priority or **Normal** priority.
 - **Host Order Time**—Time downloaded by the host or created by the GeneXpert Dx system as time received.
 - **Delete** button—Allows an order to be canceled.
 - **Host Query Status**—Displays the current status for query for new orders.
 - **Manual Query** button—Allows manual query of the host for any available new orders.

Note

To accept an order from the host, the test code for the assay must be set up by the host administrator. See [Section 2.14.5, Configuring Assay for Order and Result Upload](#) for details.

5.20.1.1 Creating a Test by Selecting from a List of Test Orders Downloaded by the Host Automatically

1. In the **Host Communication Settings** tab of the System Configuration dialog, click on the **Automatic Test Order Download** check box to select and enable this function. See [Figure 5-89](#).

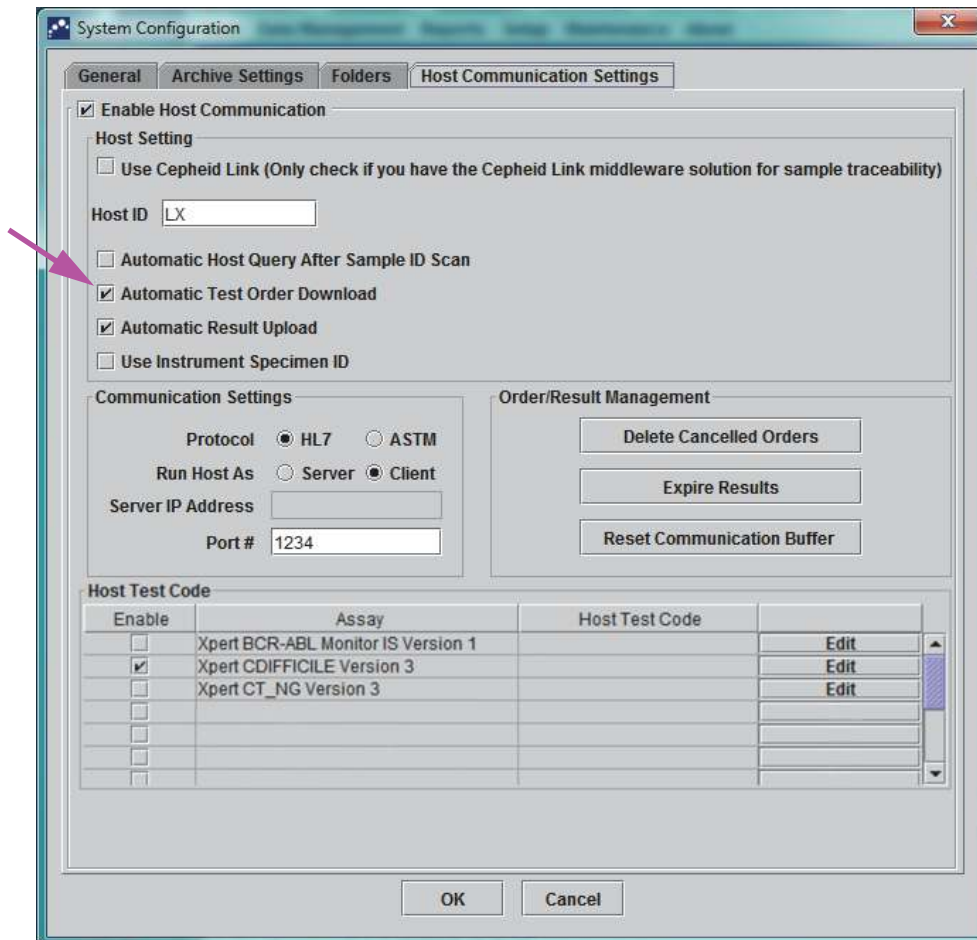

Figure 5-89. Automatic Test Order Download Selected

2. The GeneXpert Dx system periodically queries all test orders from the host. The **Create Test** button is shown with a Plus (+) sign when there are new host orders to be filled. See [Figure 5-90](#).

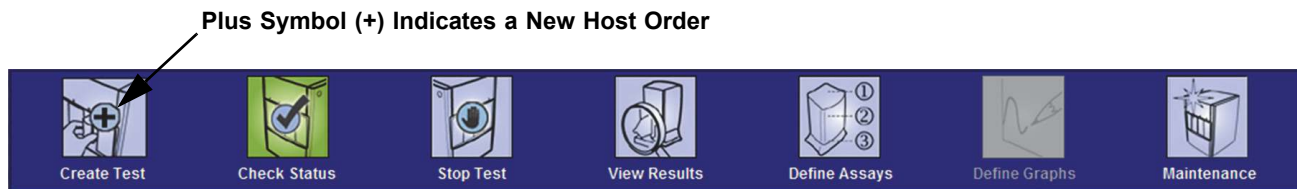

Figure 5-90. Menu Bar Indicating Plus Sign on Create Test Button

3. Click **Create Test**. Scan or enter the optional Patient ID, Patient ID 2, Patient Name, if enabled, and all three scan dialogs, if enabled (Patient ID, Sample ID, cartridge barcode). Do not use the following symbols if manually entering the Patient ID: | @ ^ ~ \ & / : * ? " < > ' \$ % ! ; () -.
4. The Scan Sample ID Barcode dialog box appears (see [Figure 5-20](#) in [Section 5.6, Creating a Test](#)).
5. Scan the sample ID barcode on the specimen container (see [Figure 5-20](#) in [Section 5.6, Creating a Test](#)).
6. New order for this optional Patient ID and Sample ID is selected in the **Host Test Order Table** section of the Create Test window, which can be sorted by clicking the table header.
7. The Scan Cartridge Barcode dialog will automatically display a prompt to scan the barcode on the cartridge. This confirms that the correct assay will be run. Reagent lot ID, expiration date, and cartridge serial number are processed and transferred.
8. The order for this Patient ID and Sample ID will be removed from the list of new orders.
9. Insert the cartridge with the specimen and reagents according to the assay-specific package insert. See [Section 5.7, Loading a Cartridge into an Instrument Module](#).
10. Click on **Start Test**, load the cartridge, and close the module door by performing the steps provided in [Section 5.8, Starting the Test](#).

Note You cannot change the Patient ID, Patient ID 2, Patient Name, Sample ID, or the assay if it is selected from a host downloaded test order.

Note If only one order matches the Patient ID and Sample ID provided by the host, this order will be automatically selected.

5.20.1.2 Creating a Test by Manually Requesting Test Orders and Selecting From the List of Test Orders

You can manually request new test orders from the host by clicking the **Manual Query** button. After orders are downloaded from the host, proceed as instructed in [Section 5.20.1.1, Creating a Test by Selecting from a List of Test Orders Downloaded by the Host Automatically](#).

5.20.1.3 Creating a Test by Querying the Host with Sample ID

1. In the **Host Communication Settings** tab of the System Configuration dialog, click on the **Automatic Host Query After Sample ID Scan** check box to select and enable this function. See [Figure 5-91](#).

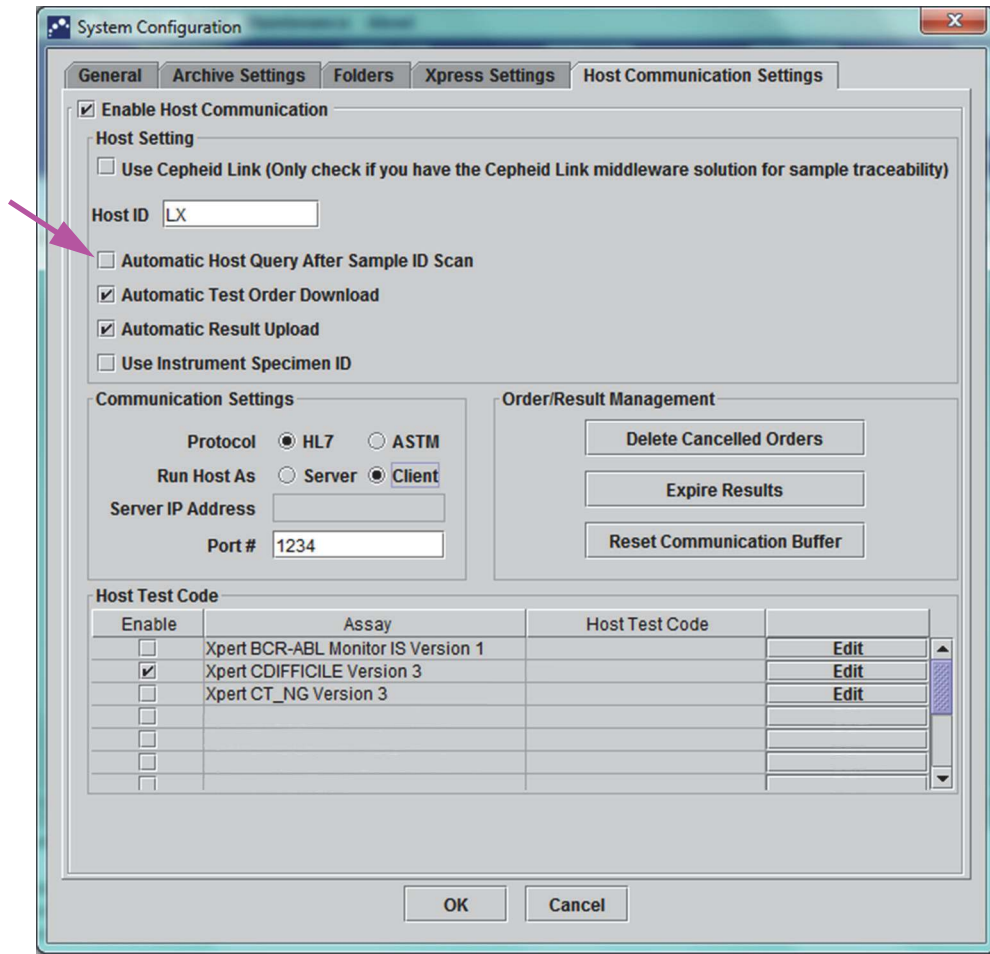

Figure 5-91. Select Host Query

2. Click **Create Test**. The Scan Sample ID Barcode dialog box appears (see [Figure 5-20](#) in [Section 5.6, Creating a Test](#)).
3. Scan the sample ID barcode on the specimen container (see [Figure 5-20](#) in [Section 5.6, Creating a Test](#)).
4. Test orders for this Sample ID are downloaded from the host and are displayed in the **Host Test Order Table** which can be sorted by clicking the header.

Note

Other downloaded orders for different samples will not be displayed in the order table for a temporary period.

5. Select an order from the table. This will select the assay according to the test order.

Note

If only one order matches the given Sample ID, this order will be automatically selected.

6. The Scan Cartridge Barcode dialog will automatically display a prompt to scan the barcode on the cartridge. This confirms that the correct assay will be run. The reagent lot ID, expiration date, and cartridge serial number are processed and transferred.
7. Insert the cartridge with the specimen and reagents according to the assay-specific package insert (see [Section 5.7, Loading a Cartridge into an Instrument Module](#)).
8. Start the test, load the cartridge, and close the module door by performing steps provided in [Section 5.8, Starting the Test](#).

5.20.1.4 Aborting a Query

During the Manual Query described in [Section 5.20.1.2, Creating a Test by Manually Requesting Test Orders and Selecting From the List of Test Orders](#) or Host Query described in [Section 5.20.1.3, Creating a Test by Querying the Host with Sample ID](#), the **Manual Query** button becomes the **Abort Query** button. See [Figure 5-92](#).

To start a test or close the dialog box, wait until the query is completed or click the **Abort Query** button to cancel the operation.

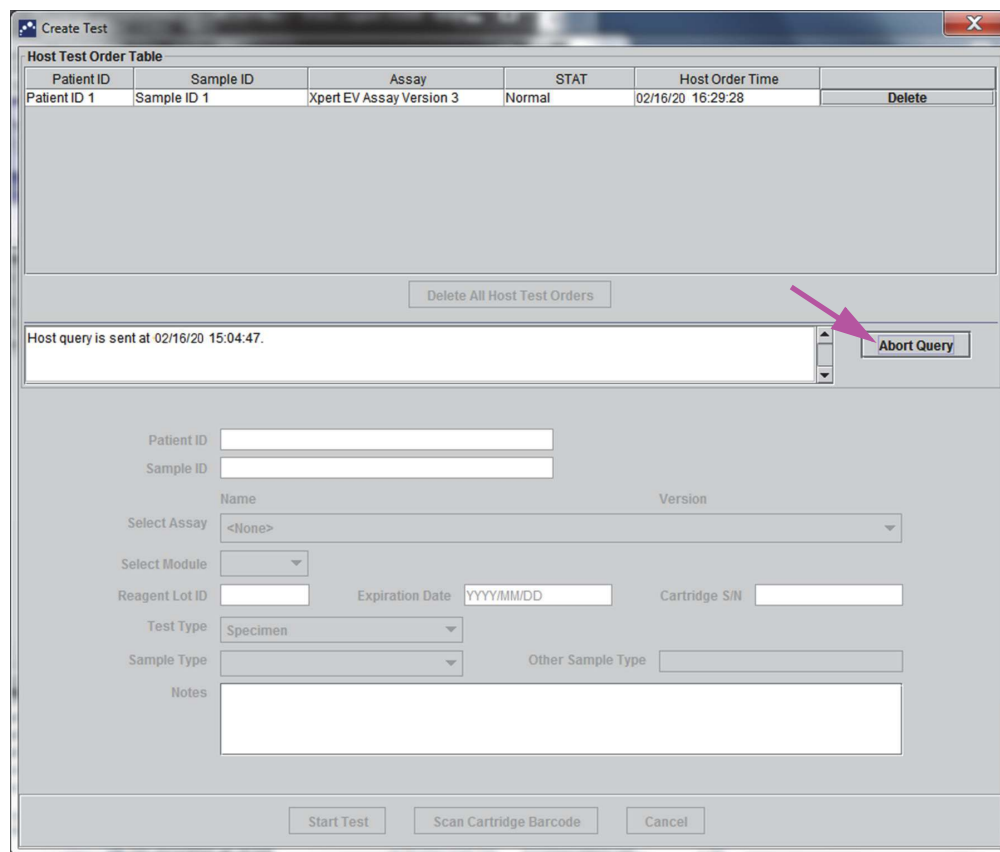

Figure 5-92. Create Test Window showing the Abort Query Button

5.20.1.5 Deleting a Host Downloaded Test Order

Occasionally, you may need to delete an order downloaded from the host.

1. Select the order from the **Host Test Order Table**.
2. Click the **Delete** button on the same row. See [Figure 5-93](#).

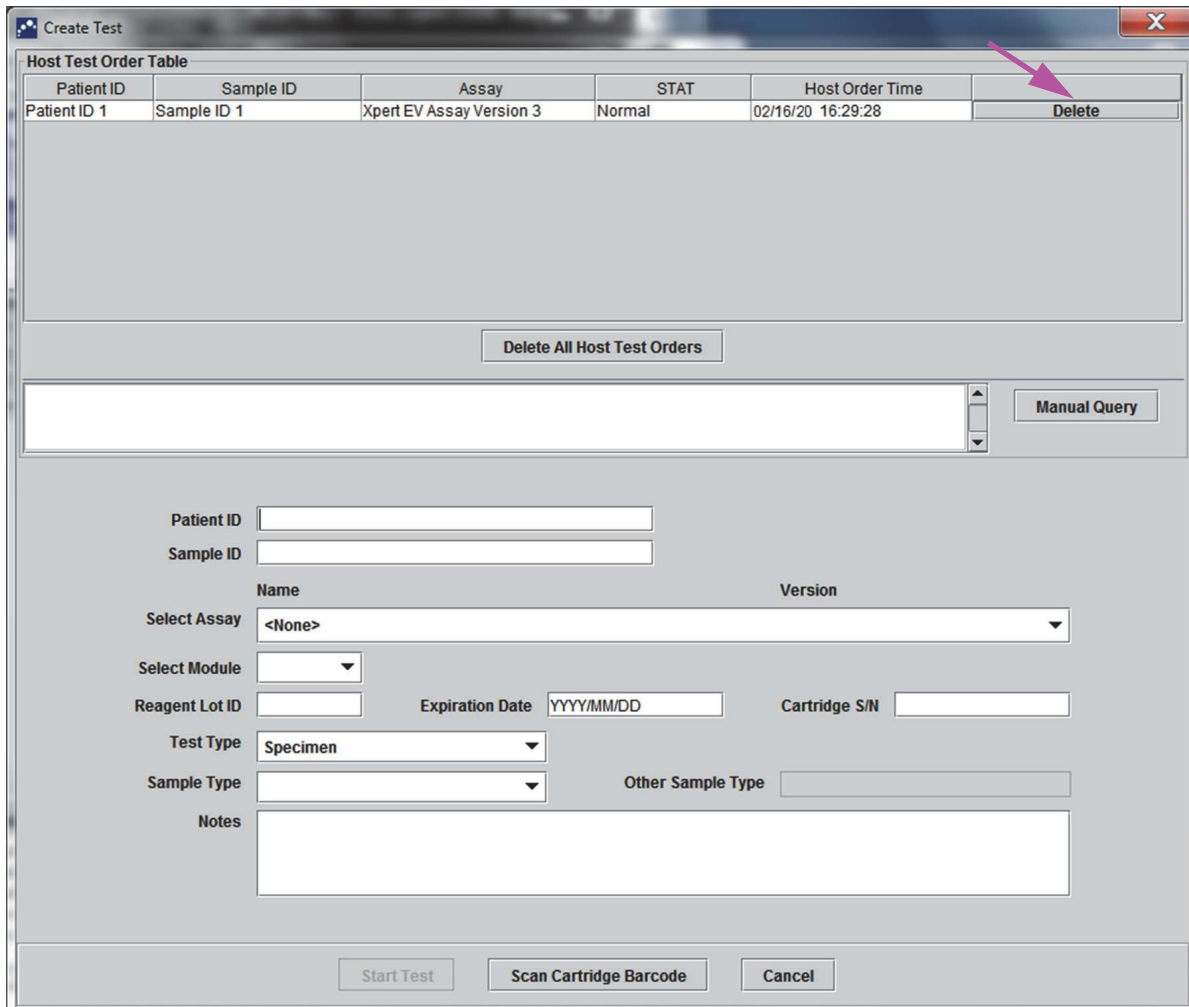

Figure 5-93. Deleting a Host Download Test Order

3. A confirmation dialog is shown. Click **OK** to confirm the deletion.
 - The order will be removed from the table.
 - The host will be informed.

5.20.2 Uploading a Test Result to the Host

Test results can be uploaded to the host either automatically or manually.

5.20.2.1 Automatically Uploading the Test Result to the Host

1. In the **Host Communication Settings** tab of the System Configuration dialog, click the **Automatic Result Upload** check box so the result will be uploaded as soon as the test is completed. See [Figure 5-94](#).

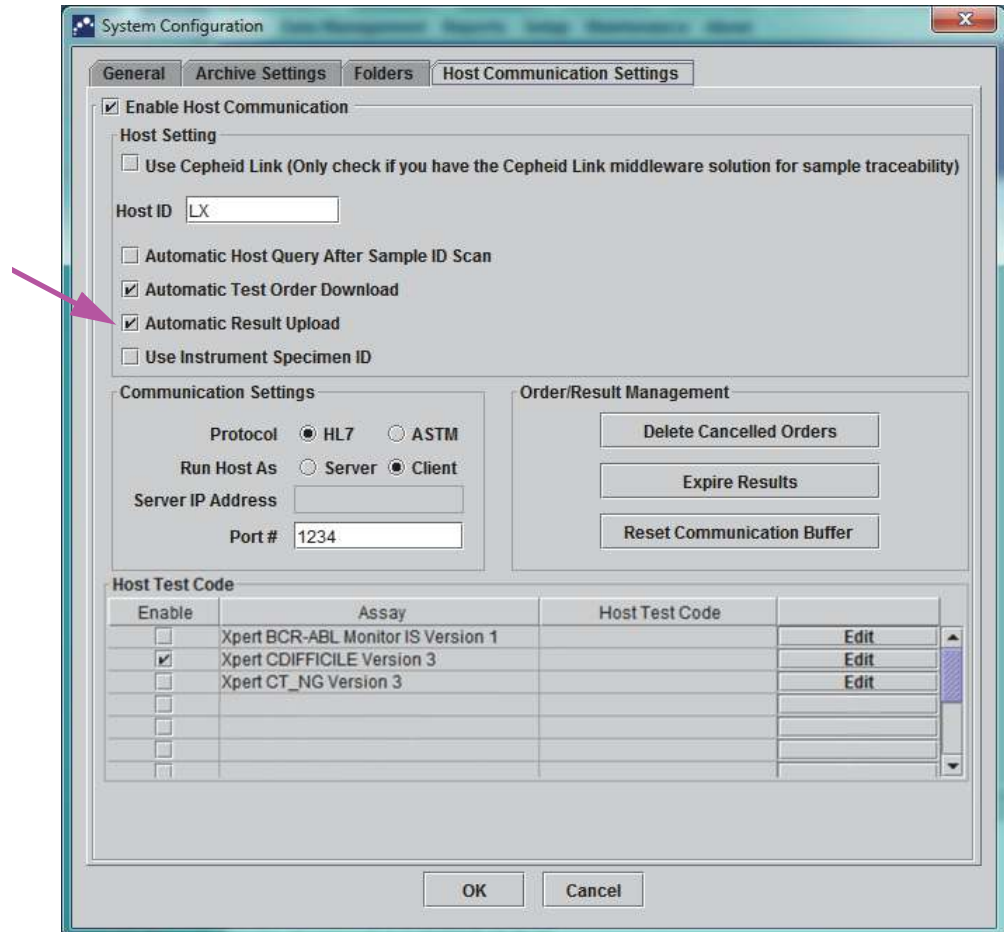

Figure 5-94. Automatic Result Upload

2. Click **OK**. Upload status is shown in the Test Information area of the View Result window.

After the test is completed, the result will be automatically uploaded. The Upload Status is shown in the Test Information area of the View Result window. See [Figure 5-95](#).

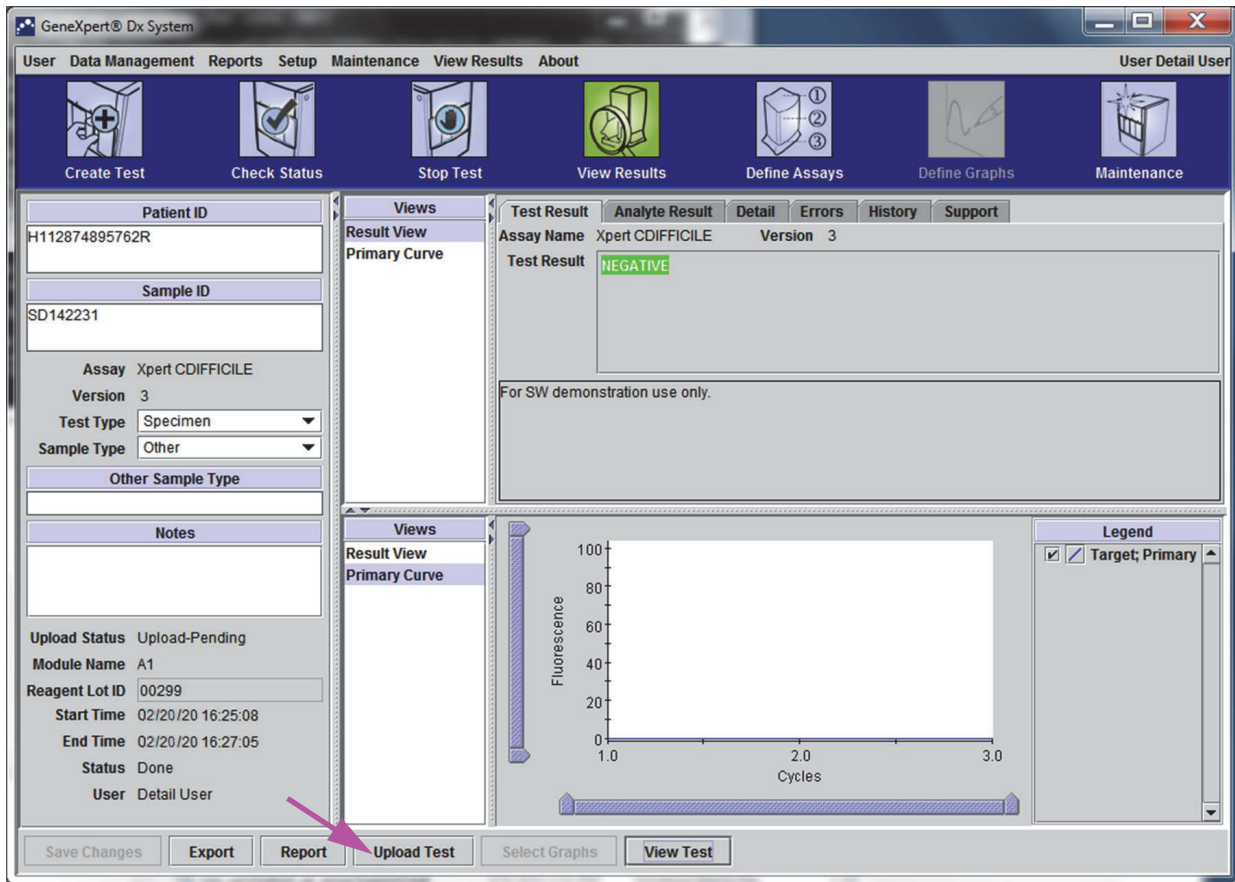

Figure 5-95. Host Upload Shown in the Test Information Area of the View Result Window

5.20.2.2 Manually Uploading a Test Result to the Host

1. In the **Host Communication Settings** tab of the System Configuration dialog, make sure **Automatic Result Upload** is deselected or disabled. See [Figure 5-94](#).
2. Click **Upload Test** in the View Results window (see [Figure 5-95](#)). The Select Test(s) To Be Uploaded To Host window appears, displaying the completed tests. See [Figure 5-96](#).

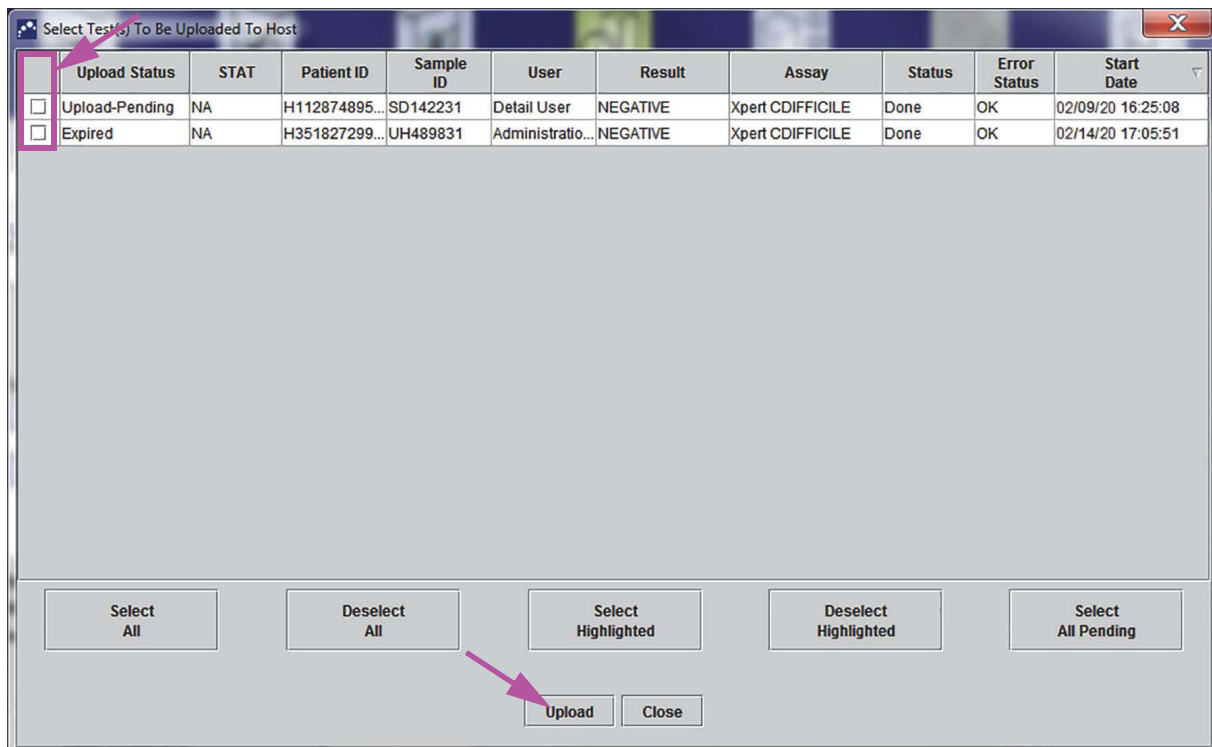

Figure 5-96. Select Test(s) to be Uploaded to the Host Window

The possible host uploaded statuses are:

- **Upload-pending**—this result has not been uploaded.
- **Uploading**—this result is being uploaded.
- **Re-Uploading**—this result has been uploaded previously and currently being uploaded again.
- **Uploaded**—this result has been received by the host.
- **Review**—this is an external control and it should be reviewed before manually uploading.
- **Expired**—test has not been uploaded and will not be alerted to the user by the system when exiting the software.

Note

If an attempt to exit the software is made with results in the upload pending, uploading or re-uploading status, the software will alert the user.

3. Select the test you want to upload. You can select the individual tests one-by-one or select a large number of tests (up to 100 tests) by clicking one of the following:
 - **Select All**—Selects all of the tests in the table.
 - **Select Highlighted**—Selects the tests you highlighted.
 - **Select All Pending**—Selects only the tests that have not been uploaded before.
4. Click **Deselect All** to clear all of the test selections in the window. Click **Deselect Highlighted** to clear the tests you highlighted.
5. Click **Upload**. A message appears and asks for confirmation of the upload request.
6. Click **Close**.

5.20.2.3 Uploading an External Control Result to the Host

Regardless of the setting for **Automatic Result Upload**, an external control result is manually uploaded. See [Section 5.20.2.2, Manually Uploading a Test Result to the Host](#).

5.20.3 Troubleshooting Host Connectivity

If there are problems with host connectivity, see [Section 9.19.3, Troubleshooting Host Connectivity](#) and [Section 9.19.4, Troubleshooting the LIS Interface](#).

5.21 Operating with Cepheid Link Connectivity

This section provides instructions on how to use Cepheid Link to scan samples and cartridges and to run the tests on the GeneXpert Dx system. The workflow for using Cepheid Link is that the test order is entered into the institution's LIS system. The Cepheid Link scanner is used to scan the samples and cartridges either near the GeneXpert Dx system or remotely. The cartridges are then transported to the GeneXpert Dx system to run the tests. Test results are uploaded to the institution's LIS system.

Important

Once the system has been configured for Cepheid Link, it cannot be used for non-LIS originated test orders or for running external controls without disabling Cepheid Link. Cepheid Link may be enabled again after running non-LIS originated test orders or external controls. Configuration for Cepheid Link is described in [Section 2.14.4.2, Configuring Host Communications for Cepheid Link](#)

- [Section 5.21.1, Scanning a Sample and Cartridge using Cepheid Link](#)
- [Section 5.21.2, Running Cartridges Scanned from Cepheid Link](#)

Caution



Cepheid recommends to always confirm that LIS uploaded results match GeneXpert test results after any changes to the GeneXpert or host system, including (but not limited to) changes to the following:

- GeneXpert software version
- GeneXpert Assay Definition version
- GeneXpert host communication settings
- Host middleware software or configuration changes
- LIS software or configuration settings

5.21.1 Scanning a Sample and Cartridge using Cepheid Link

After an order is entered into the LIS, system, use the Cepheid Link scanner to scan the sample and cartridge. This procedure assumes that the Cepheid Link scanner has been set up following the instructions in the *Cepheid Link User Guide* and the scanner has already been powered on.

Important

In order to scan a sample and cartridge, an order for the test must have been previously entered into the institution's LIS system.

1. Remove the scanner from the docking station.
2. If the scanner screen is locked, swipe the screen upward vertically to unlock the screen.
3. Log into the Cepheid Link scanner using your assigned user name and password (see [Figure 5-97](#)). The Scan Sample screen will be displayed. See [Figure 5-98](#).

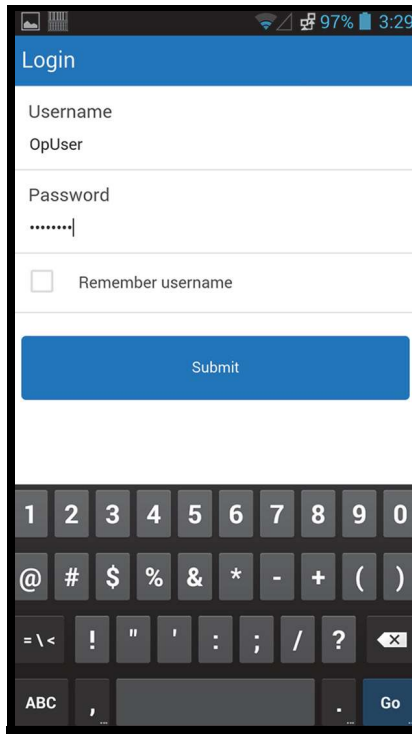

Figure 5-97. Cepheid Link Scanner Login Screen

4. Scan the sample ID using the scanner:
 - To scan the sample ID:
 - 1) Press and hold the blue scanner button (located on either side of the barcode scanner) to scan the sample barcode. The sample barcode will be scanned and Cepheid Link will check to see if there is a test order for the sample.
 - 2) If an order was found, the Success screen (green check mark) will be displayed for a very short time (see [Figure 5-99](#)) and the Scan Cartridge screen will be displayed. See [Figure 5-102](#).
 - 3) If an order was not found, the Error screen (Order Not Found (red X)) will be displayed (see [Figure 5-100](#)). Touch the **Ok** button to return to the Scan Sample screen.
 - If a sample barcode is not available, to enter the sample ID manually:
 - 1) Touch the **Barcode** area of the screen (see [Figure 5-98](#)). A keyboard will be displayed (see [Figure 5-101](#)) to enter the sample ID manually.
 - 2) Manually enter the sample ID using the keyboard.
 - 3) Press the **Submit** button to submit the sample ID.
 - 4) If an order was found, the Success screen (green check mark) will be displayed for a very short time (see [Figure 5-99](#)) and the Scan Cartridge screen will be displayed. See [Figure 5-102](#).

- 5) If an order was not found, the Error screen (Order Not Found (red X)) will be displayed (see [Figure 5-100](#)). Touch the **Ok** button to return to the Scan Sample screen.

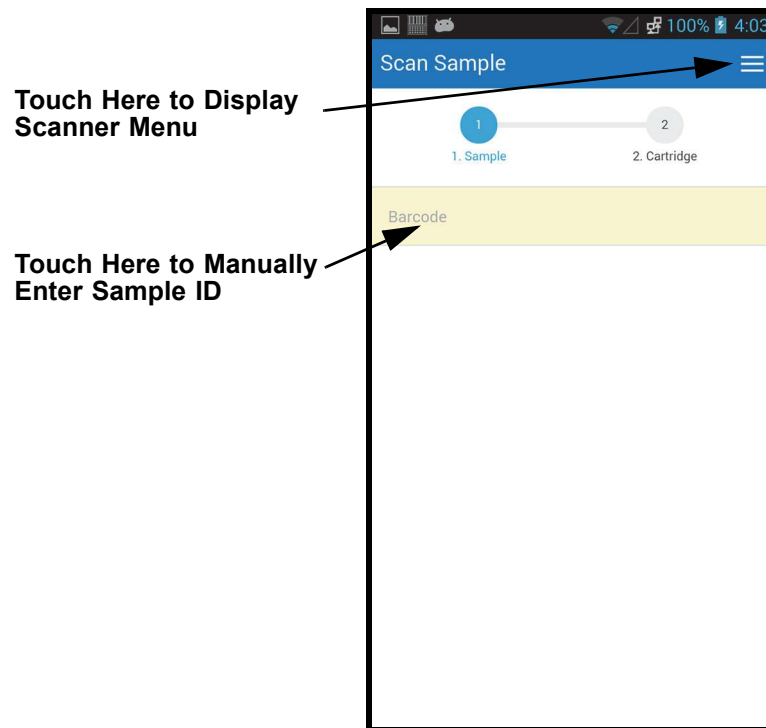

Figure 5-98. Cepheid Link Scan Sample Screen



Figure 5-99. Cepheid Link Scanner Success (Green Check Mark) Screen

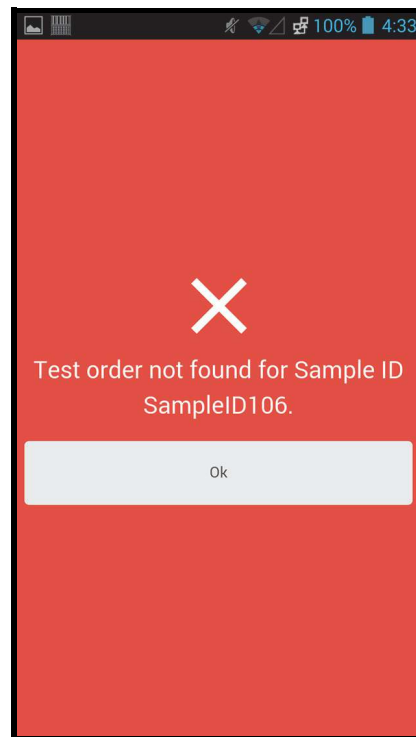

Figure 5-100. Cepheid Link Scanner Error (Order Not Found (Red X)) Screen

Touch Submit Button
After Entering Sample ID

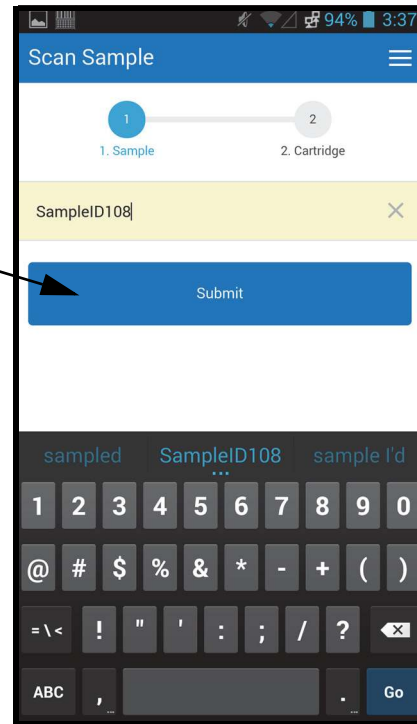

Figure 5-101. Sample ID Manual Barcode Entry

Touch Start Over to
Return to the Scan
Sample Screen.

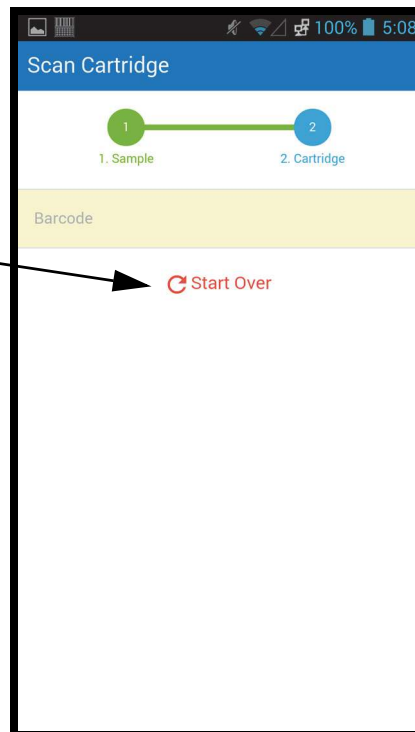

Figure 5-102. Cepheid Link Scan Cartridge Screen

5. Scan the cartridge barcode:
 - Press the scanner button (located on either side of the barcode scanner) to scan the cartridge barcode. After the cartridge barcode has been successfully scanned, Cepheid Link will pair the cartridge with the sample. The scanner will momentarily display the scanned cartridge information (see [Figure 5-103](#)).
If the cartridge is successfully paired with the sample, the Success screen (green check mark) will be displayed for a very short time (see [Figure 5-99](#)).
 - If the cartridge is not successfully paired with the sample, the Error (Red X) screen will be displayed along with the error message (see [Figure 5-104](#)) for an example. Touch the **Ok** button to return to the Scan Cartridge screen. The scanner will return to the Scan Sample screen (see [Figure 5-98](#)).
 - If aliquots are to be scanned, the Scan Aliquot screen will be displayed (see [Figure 5-105](#)).
 - The scanner will display the Confirmation screen (see [Figure 5-106](#)), if aliquots are not required and if Confirmation is enabled, or will return to the Scan Sample screen (see [Figure 5-98](#)).
 - Touch **Start Over** to not scan the aliquot and return to the Scan Sample screen. See [Figure 5-98](#). A confirmation screen will be displayed after touching the **Start Over** button.
6. **(Optional)** If the sample requires an aliquot to be scanned, the Scan Aliquot screen will be displayed (see [Figure 5-105](#)).
 - Press the scanner button (located on either side of the barcode scanner) to scan the aliquot barcode. The aliquot barcode will be scanned.
 - If the aliquot is successfully scanned, the Success screen (green check mark) will be displayed for a very short time (see [Figure 5-99](#)).
 - If the assay is set up for aliquots but the sample has not been divided into aliquots, touch **Skip** to skip scanning an aliquot. The scanner will display the Confirmation screen (see [Figure 5-106](#)), if aliquots are not required and if Confirmation is enabled, or will return to the Scan Sample screen (see [Figure 5-98](#)).
 - If aliquots are to be scanned, the Scan Aliquot screen will be displayed (see [Figure 5-105](#)).
 - Touch **Start Over** to not scan the aliquot and return to the Scan Sample screen (see [Figure 5-98](#)). A confirmation screen will be displayed after touching the **Start Over** button.
7. **(Optional)** The scanner will display the Confirmation screen (see [Figure 5-106](#)), if enabled, or will return to the Scan Sample screen (see [Figure 5-98](#)).
8. If the Confirmation screen is displayed, touch **Start Over** to go to the Scan Sample screen. See [Figure 5-98](#).

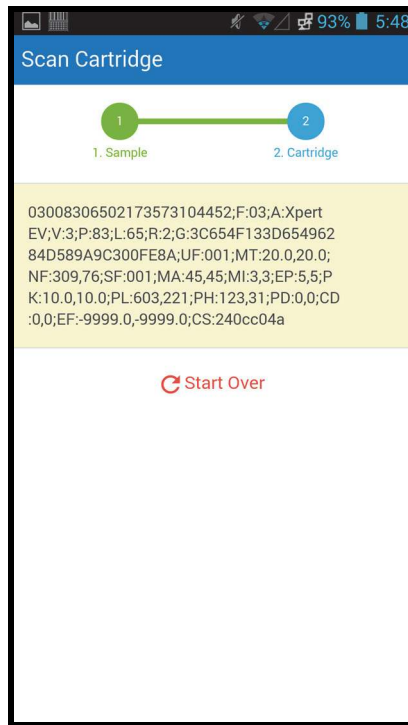

Figure 5-103. Cepheid Link Scanned Cartridge Information Screen

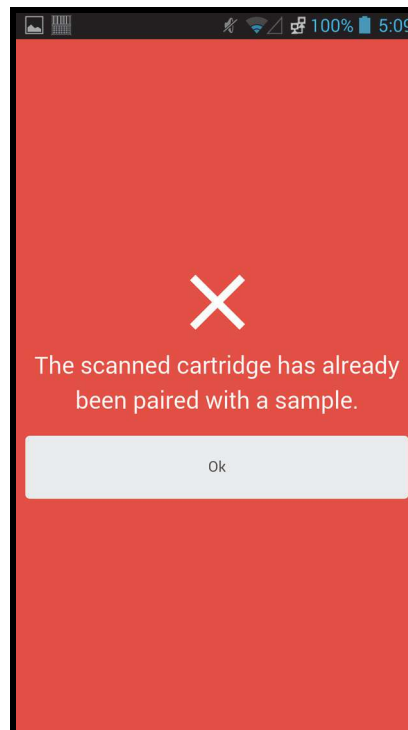

Figure 5-104. Cepheid Link Scanned Cartridge Error Screen

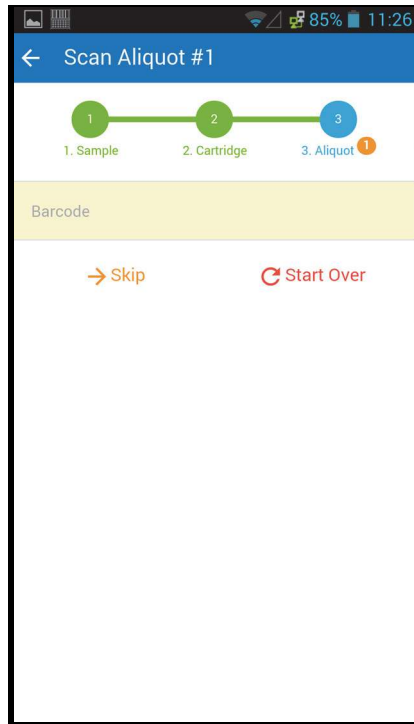

Figure 5-105. Cepheid Link Scan Aliquot Screen

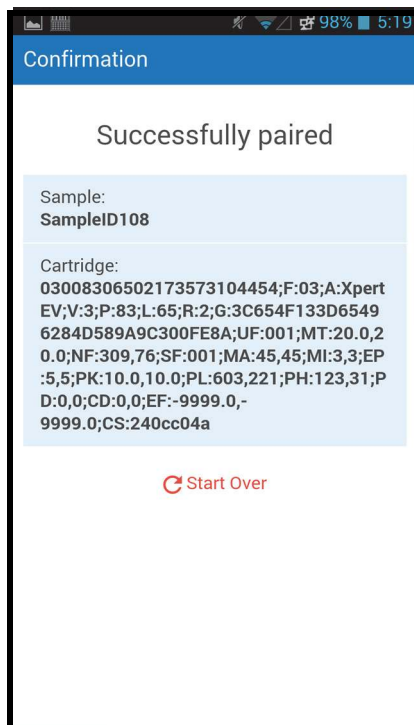

Figure 5-106. Cepheid Link Confirmation Screen

9. To scan additional samples and cartridges, go to [Step 4](#) on [page 5-98](#).

10. When all samples and cartridges have been scanned, log off the Cepheid Link. Access the scanner menu by touching the Menu icon in the drop down menu (see [Figure 5-98](#)). The scanner menu will be displayed. See [Figure 5-107](#).
11. On the scanner menu, touch **Logout**. The logout dialog will be displayed at the bottom of the screen. See [Figure 5-108](#).
12. On the logout dialog, touch OK to log off the scanner (see [Figure 5-108](#)). The scanner Login screen will be displayed. See [Figure 5-97](#).
Select **Cancel** if you do not want to log off the scanner.
13. Return the scanner to the docking station.

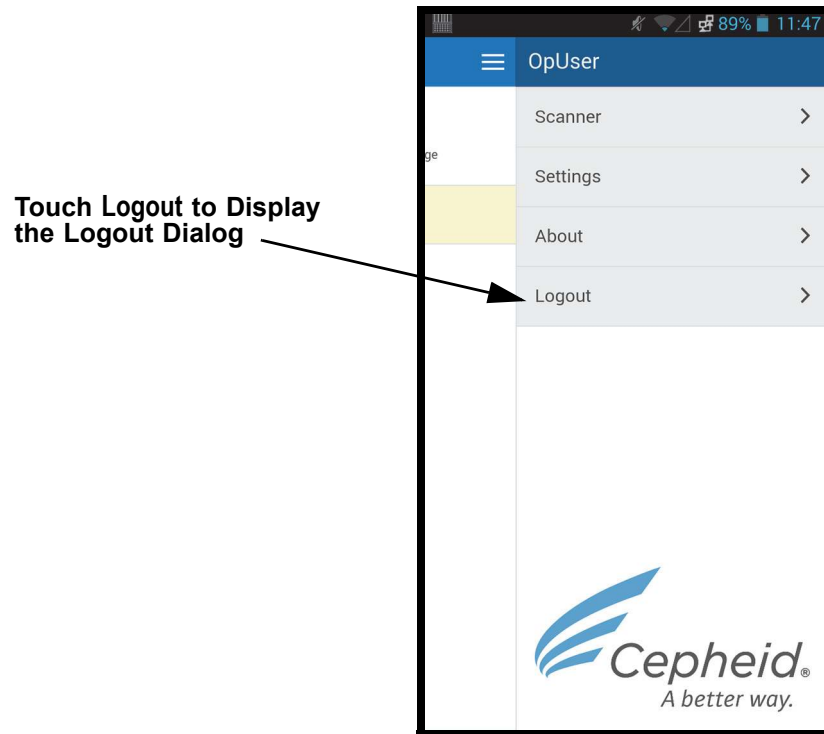

Figure 5-107. Cepheid Link Scanner Drop Down Menu

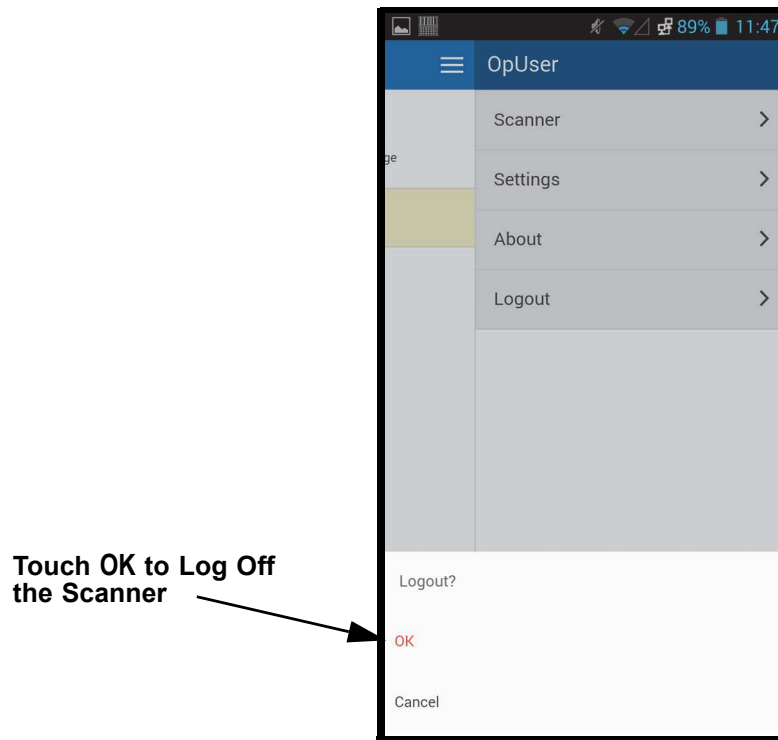

Figure 5-108. Cepheid Link Scanner Logout Dialog

5.21.2 Running Cartridges Scanned from Cepheid Link

After cartridges have been scanned using Cepheid Link, they are transported to the GeneXpert Dx system to run the tests.

Important

The system must be configured for Cepheid Link before running tests using this procedure. Configuration for Cepheid Link is described in [Section 2.14.4.2, Configuring Host Communications for Cepheid Link](#)

The ordering process will be demonstrated using a series of screenshots that direct you to either scan or type in test information.

To run tests on the GeneXpert Dx system:

1. In the GeneXpert Dx system Home screen, select the **Create Test** button. See [Figure 5-109](#).

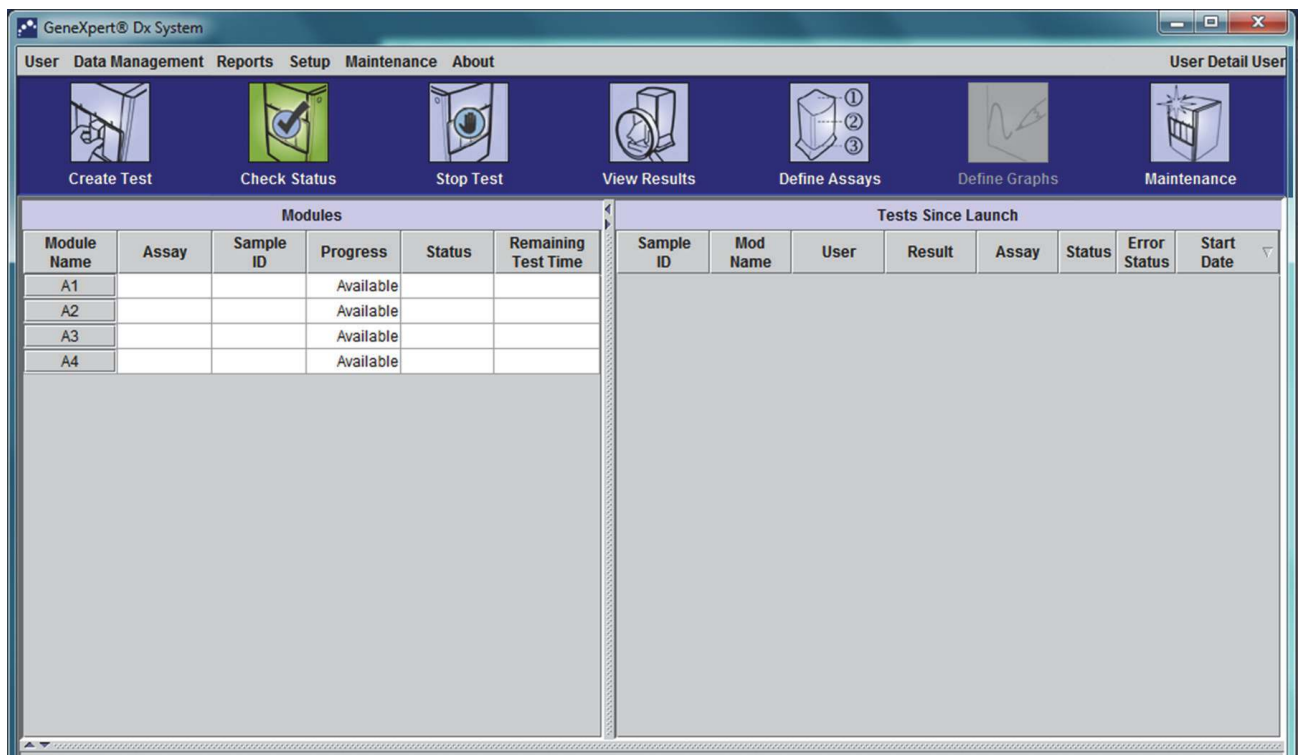

Figure 5-109. GeneXpert Dx Home Screen

- The Host Test Order screen will be displayed with a Scan Cartridge Barcode overlay screen. See [Figure 5-110](#).

Select the **Cancel** button if you do not want to run a test.

Note

Even though the patient demographics fields are displayed in the host screens, data cannot be entered into the fields.

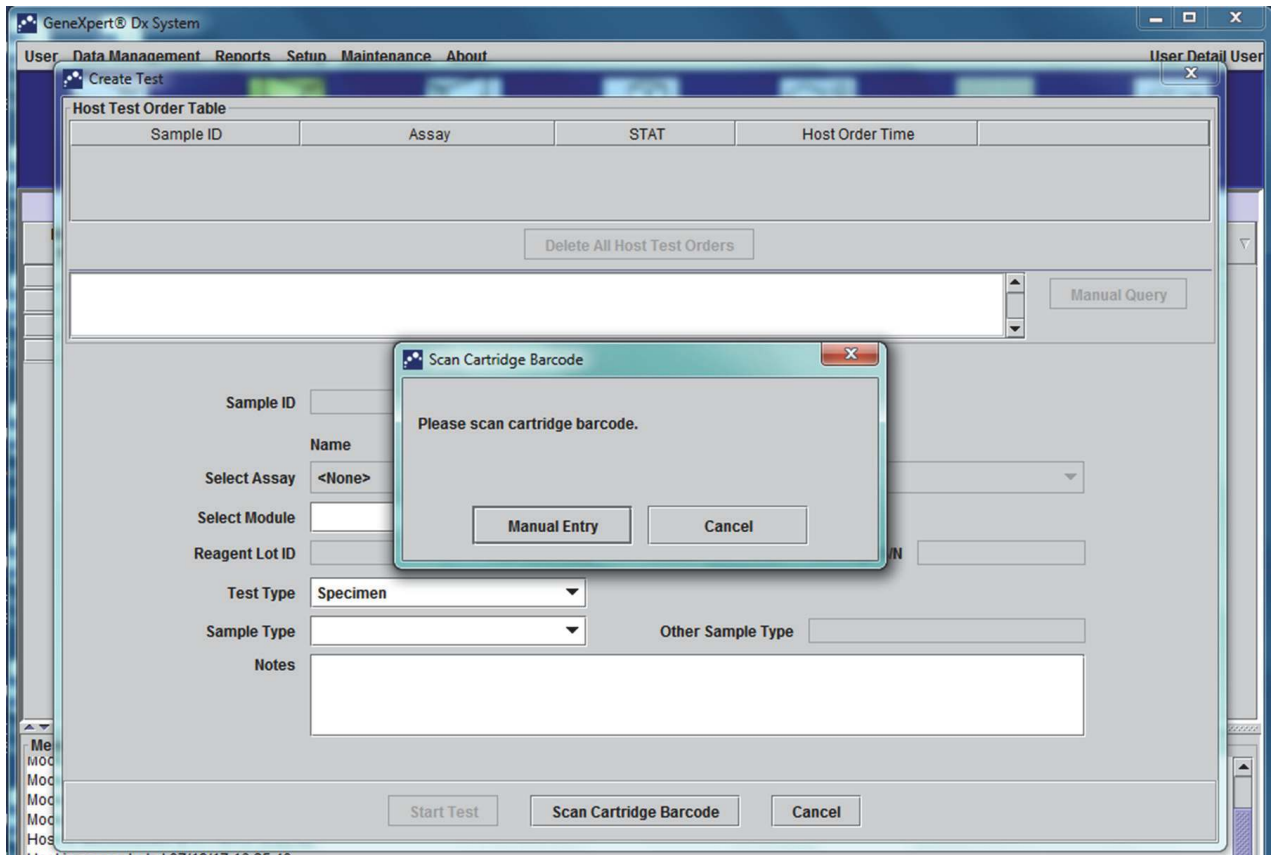

Figure 5-110. Orders Table with Scan Cartridge Barcode Overlay Screen

3. As instructed in [Figure 5-110](#), scan the cartridge barcode using the supplied scanner.

The GeneXpert Dx system will query the Cepheid Link system to verify that the order exists on the system. If the order exists, the order will be downloaded to the GeneXpert Dx system. (see [Figure 5-111](#)).

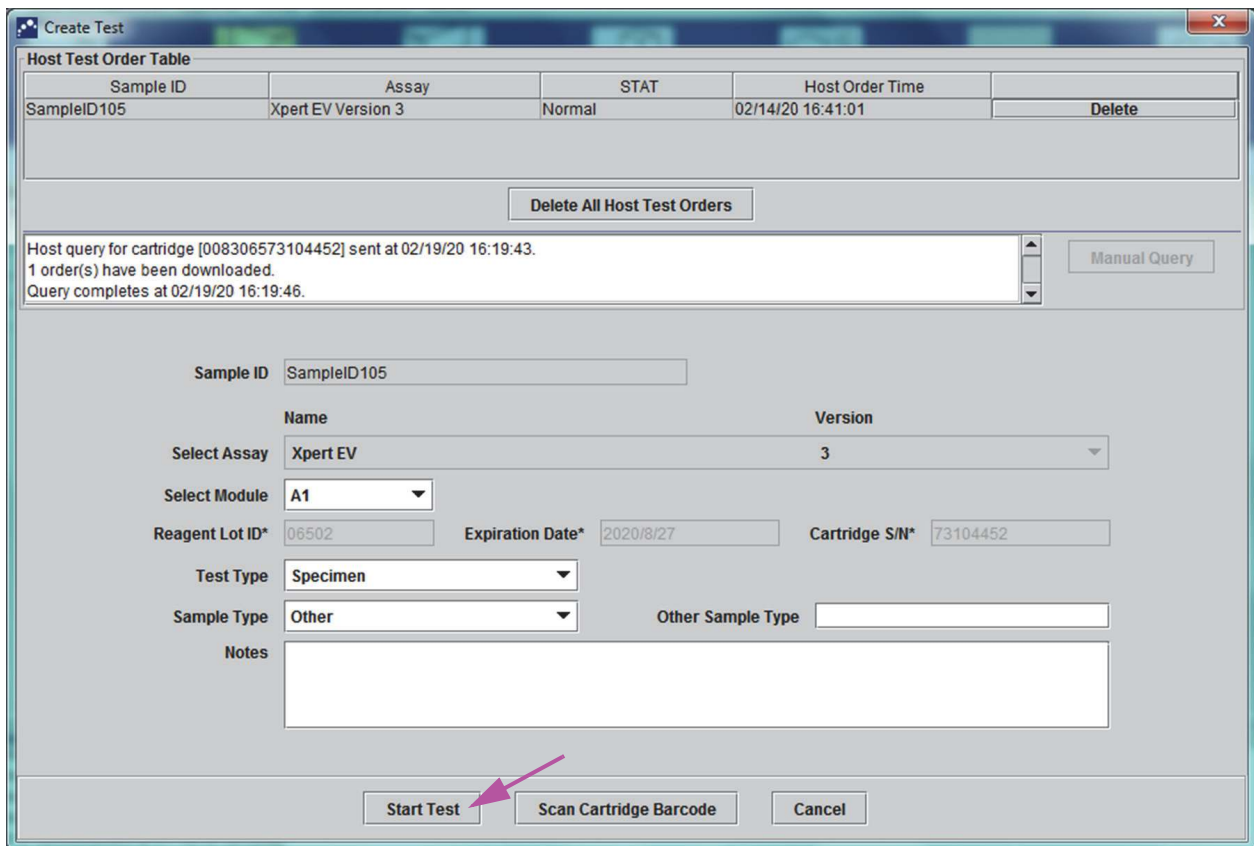

Figure 5-111. Create Test Screen, showing Cartridge Query Completed

4. On the **Host Test Order Table** section, (see [Figure 5-111](#)), review the order. Enter additional information or notes, if necessary, then select the **Start Test** button. The GeneXpert Home Screen appears, displaying a message to load the cartridge into the module, which is highlighted in green. See [Figure 5-112](#).

Note

You cannot change the Patient ID (if enabled), Sample ID, patient demographics information or the assay if it is downloaded from a Link test order.

5. If required, log in to start the test.
You can monitor the test process or other status indicators in the **Modules** or **Messages** areas of the GeneXpert Dx System window. See [Figure 5-30](#).

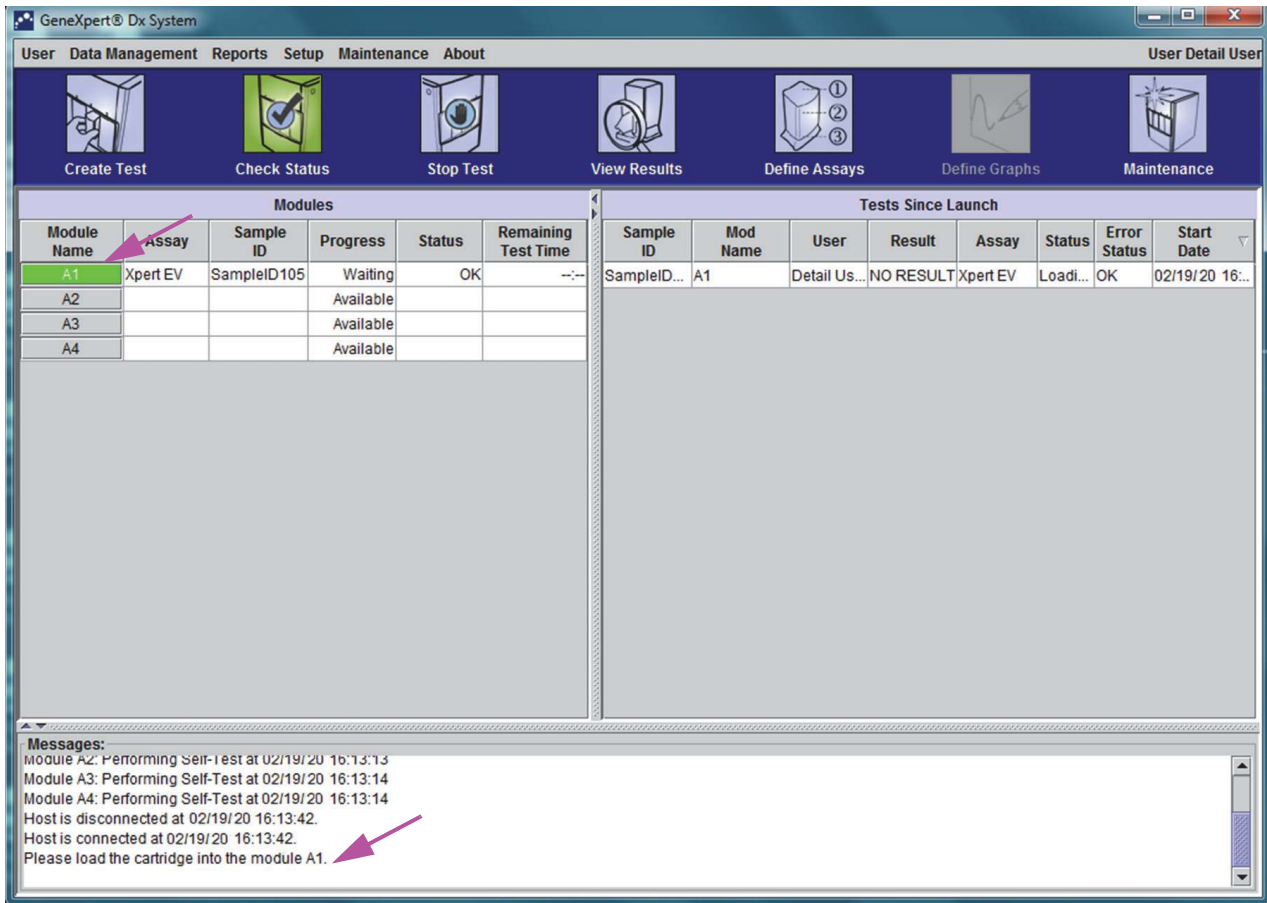

Figure 5-112. GeneXpert Home Screen, showing the Cartridge Loading Message

- Continue scanning cartridges for testing by repeating Step 1 (page 5-106) through Step 5 (page 5-109) until all cartridges have been processed.

5.22 System Information

Information about the system and software can be obtained by clicking on the About menu at the top of the GeneXpert Dx System window (see [Figure 5-113](#)) and selecting **About GeneXpert® DX System**. The About GeneXpert Dx System window will be displayed. See [Figure 5-114](#).

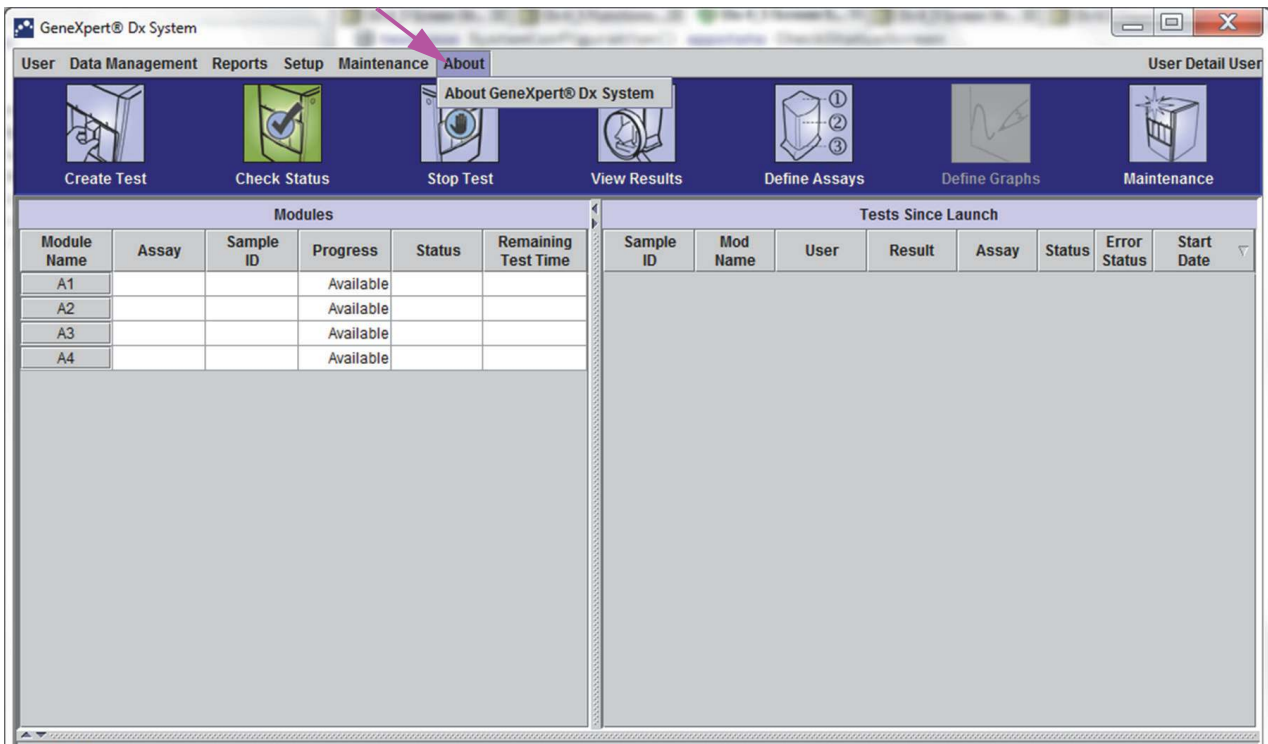

Figure 5-113. GeneXpert Dx System—About Drop-Down Menu

The About GeneXpert Dx System window displays specific information about the instrument and software such as:

- Software version number
- Copyright statement
- Various version numbers of software utilities used on the system
- Instrument serial numbers and firmware version
- Module numbers and firmware version numbers

To view the GeneXpert Dx software license agreement, click on the **License** button. See [Figure 5-114, About GeneXpert Dx System Window](#). You may read the complete software license agreement by scrolling through the document in Adobe Reader. When finished, close Adobe Reader.

Click **Close** to close the About GeneXpert Dx System window.

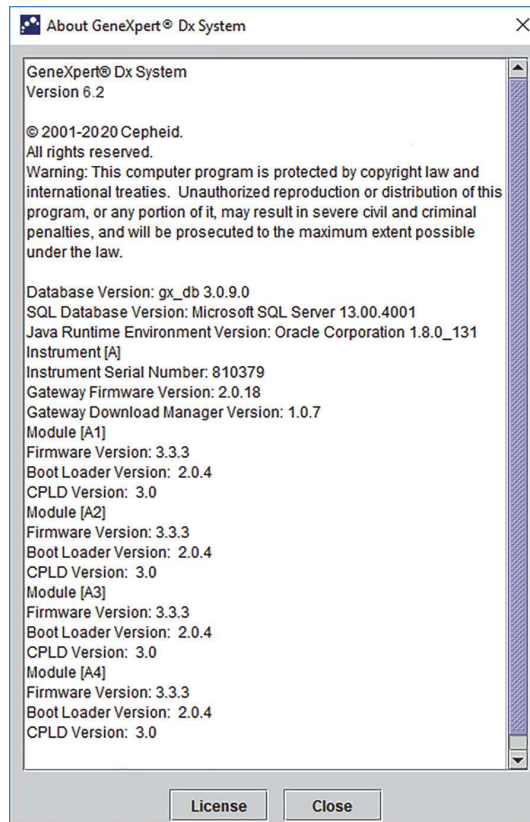

Figure 5-114. About GeneXpert Dx System Window

6 Calibration Procedures

This chapter describes the following:

- [Section 6.1, Calibration](#)
- [Section 6.2, Quality Control](#)
- [Section 6.3, External Quality Controls](#)
- [Section 6.4, Qualitative Assays vs. Quantitative Assays](#)
- [Section 6.5, Control Trend Reports](#)

6.1 Calibration

Calibration of the GeneXpert instrument is not required during the initial system setup. Cepheid performs all of the necessary calibrations before the system is shipped. However, Cepheid recommends that the system be checked for proper calibration on an annual basis from the point of initial use. Based upon the usage and care of each system, calibration checks may be recommended more frequently. The system is designed to measure module performance with the internal assay controls. In the event of a module replacement, the replacement module provided will have been calibrated prior to shipment.

A GeneXpert operator or Field Service Engineer with Administrator user permissions can perform calibration checks during annual maintenance. Contact Cepheid Technical Support for information about calibration checks. See the [Technical Assistance](#) section in the [Preface](#) for contact information.

6.2 Quality Control

Quality control is an important part of *in vitro* diagnostic testing because it helps ensure you are performing the tests correctly and that your GeneXpert Dx system is working properly. The GeneXpert Dx system automatically performs internal quality control for each sample. During each test, the system uses one or more of the following controls that must be positive to report a negative test result:

- **Sample-Processing Control (SPC)**—Helps ensure that a sample was correctly processed. The sample-processing control, which is included in the cartridge, is processed with the sample and detected by PCR.
- **Internal Control (IC)**—Helps verify the performance of the PCR reagents and the absence of significant inhibition that would prevent PCR amplification

- **Endogenous Control (EC)**—Normalizes targets and/or helps ensure sufficient sample is used in the test. The endogenous control is from the test sample.

In addition to the controls, the GeneXpert Dx system performs a probe check during the first stage of the test. A probe check verifies the presence and the integrity of the labeled probes. A probe-check status of **Pass** indicates that the probe check results meet the acceptance criteria.

6.3 External Quality Controls

External controls may be used in accordance with local, state, or federal accrediting organizations, as applicable. External controls can be trended if an external control test type is assigned when the test is created. For additional information, see the quality label or package insert for the specific assay. During Order Test, select the appropriate Test Type for the controls being tested.

6.4 Qualitative Assays vs. Quantitative Assays

The Control Trend Report may be generated for both qualitative assays and quantitative assays. After selecting the assay, to trend quantitative assay results, check the **Use Quantitative Data** check box. For qualitative assays, the **Use Quantitative Data** check box is grayed out.

Note

It is possible to trend qualitative assay results on an assay that uses quantitative data. Do not check the **Use Quantitative Data** check box.

6.5 Control Trend Reports

The Control Trend reports can be used to verify the quality of the system, reagents or specimens. For example, a negative-control trend report can be generated to check for cross-contamination. Other external-control trend reports can be generated to check for reagent degradation.

Note

The following procedure shows how to perform both qualitative assay control trend reports and quantitative assay control trend reports.

To view the control trends:

1. In the GeneXpert Dx System window on the **Reports** menu, click **Control Trend Report** (see [Figure 6-1](#)). The Control Trend Report dialog box is displayed. See [Figure 6-2](#).

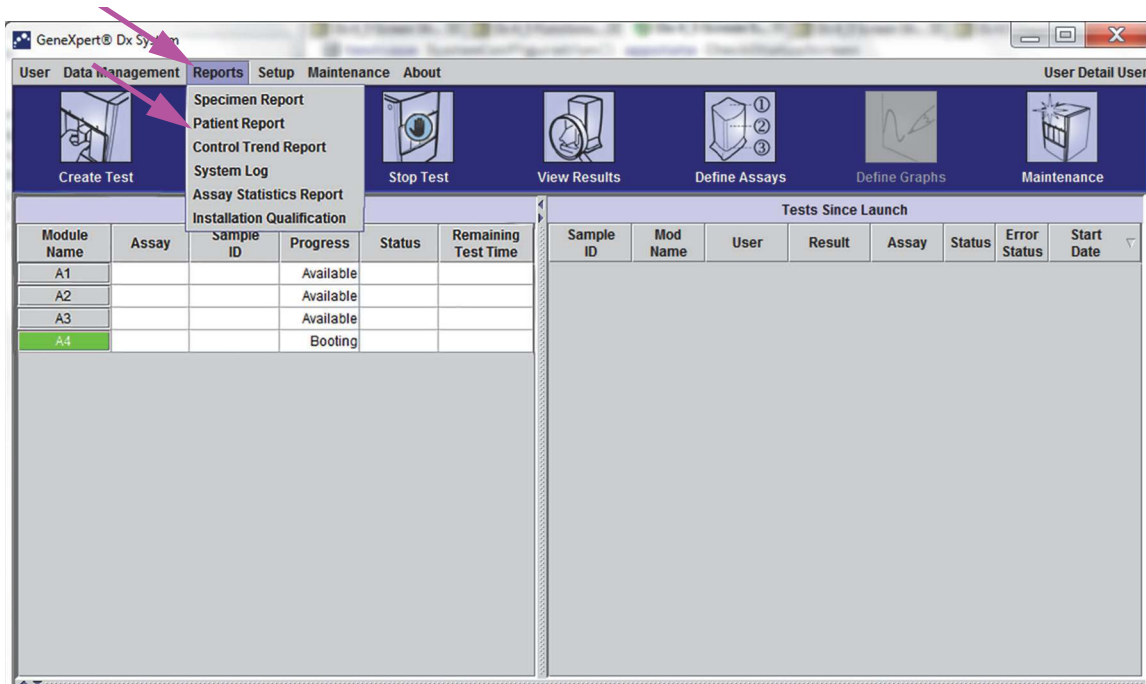

Figure 6-1. GeneXpert Dx System Screen Displaying Reports Menu

2. Select the Date Range. Select **All** to include all of the tests or click the **Select** button to filter the tests by specifying a range of dates.
3. Select the assay to generate the Control Trend Report. See [Figure 6-2](#) for a qualitative assay selection and [Figure 6-4](#) for a quantitative assay selection.

Note

Control trending is not available for % Ratio quantitative assays.

4. If the assay selected is a qualitative assay, the **Use Quantitative Data** check box is not displayed (see [Figure 6-2](#)). If the assay selected is a quantitative assay, the **Use Quantitative Data** check box will be available (see [Figure 6-4](#)). Check the **Use Quantitative Data** check box to generate the Control Trend Report using quantitative data.
5. If the assay contains multiple reagent lot numbers, select the lot number to use for the Control Trend Report using the **Reagent Lot Number** drop down.

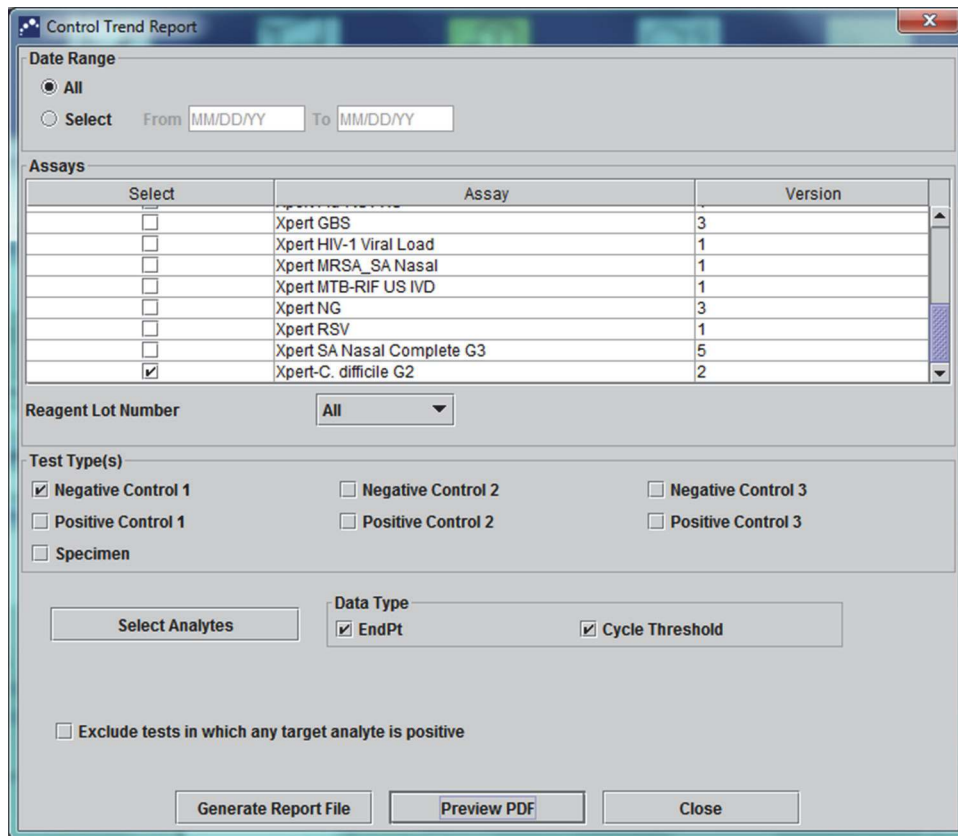

Figure 6-2. Control Trend Report Dialog Box Showing Qualitative Assay Selected

6. Specify the following criteria to view the trends of interest:
 - Qualitative Assay Options (see Figure 6-2):
 - **Test Type(s)**—Select the external-control trend types to be trended. For the example in this chapter, **Negative Control 1** was selected.
 - **Select Analytes** button—Select the analytes. Press the **Select Analytes** button to display the analytes applicable to this assay. The Select Analytes dialog box is displayed. See Figure 6-3.
 - Ensure that desired analytes are listed under the **Selected Analytes** column.
 - If additional analytes should be added to the **Selected Analytes** column, highlight the analyte under the **Available Analytes** column, click the **Right Arrow** key to move the analyte to the **Selected Analytes** column and press the **OK** button. The Select Analytes dialog box closes.
 - If analytes should be removed from the **Selected Analytes** column, highlight the analyte under the **Selected Analytes** column, click the **Left Arrow** key to move the analyte to the **Available Analytes** column and press the **OK** button. The Select Analytes dialog box closes.

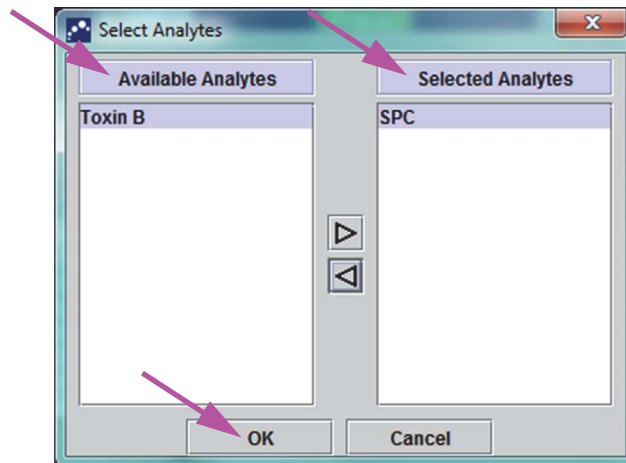

Figure 6-3. Select Analytes Dialog Box

- **Data Type**—Select the data type. For this example, the **Cycle Threshold** and **EndPoint** data are selected to be trended.
- **Exclude tests in which any target analyte is positive** check box—Select this check box to not include tests in which the target analyte is positive from the report.
- Quantitative Assay Options (see [Figure 6-4](#)):
 - **Test Type(s)**—Select the external-control trend types to be trended. For the example in this chapter, **Positive Control 1** was selected.
 - **Plot quantitative value in log format** check box—Select the format of the data to be plotted. For the example in this chapter, **Plot quantitative value in log format** was selected.
 - **Customize Graph Limits** button—Select the data limits to be used for plotting the data. Press the **Customize Graph Limits** button. The Customize Graph Limits dialog box is displayed. See [Figure 6-5](#).

For each Test Type selected, enter the **Target**, **Upper Limit** and **Lower Limit**. For this example, the **Target** was set to **200.00**, the **Lower Limit** was set to **96.00** and the **Upper Limit** was set to **991.00**. The **Target** must be between the **Upper Limit** and the **Lower Limit**.

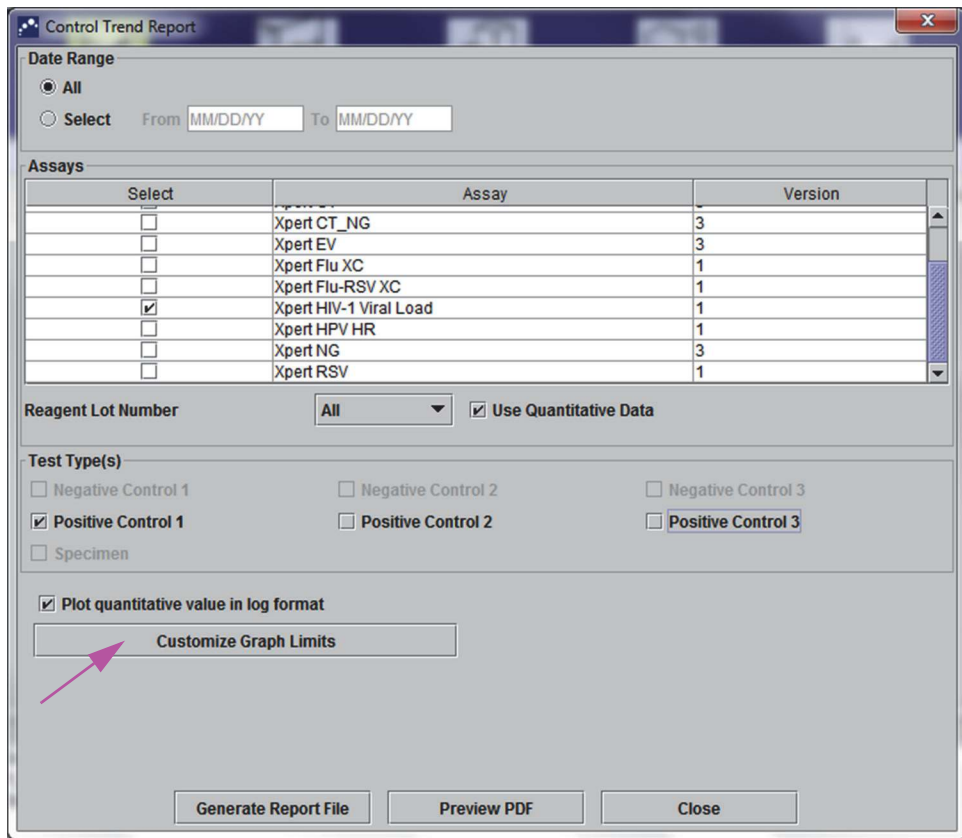

Figure 6-4. Control Trend Report Dialog Box Showing Quantitative Assay Selected

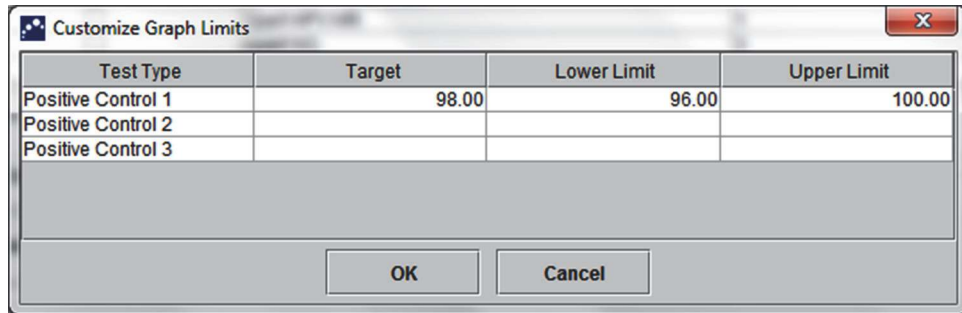

Figure 6-5. Customize Graph Limits Dialog Box

7. After selecting the trend criteria, click one or more of the following options:
- Generate Report File**—Creates a PDF file and saves it to the location you specify. Click the **Generate Report File** button on the Control Trend Report dialog box (see [Figure 6-2](#) for qualitative assay trends and [Figure 6-4](#) for quantitative assay trends) to create the PDF file of the report. The Generate Report File dialog box is displayed (see [Figure 6-6](#)), which enables you to save the file to a specified location.

Click the **Save** button once you have navigated to the specific location. To view the Control Trend Report, go to the location where you saved the report, open the report and print it, if desired.

Click the **Cancel** button to not save the Control Trend Report, if desired.

Note

The default location for saving the Control Trend Report is the **Report** folder.

- Preview PDF**—Creates a PDF file and displays the file in the Adobe Reader window. Click the **Preview PDF** button on the Control Trend Report dialog box (see [Figure 6-2](#) for qualitative assay trends and [Figure 6-4](#) for quantitative assay trends) to create the PDF file of the report (see [Figure 6-7](#)). The PDF file can be saved and printed from the Adobe Reader software.

Note

The length of the Control Trend Report can be very long depending upon the number of test types and data types selected.

- Close**—Click **Close** when you are done to close the Control Trend Report dialog box or if you do not wish to generate a Control Trend Report.

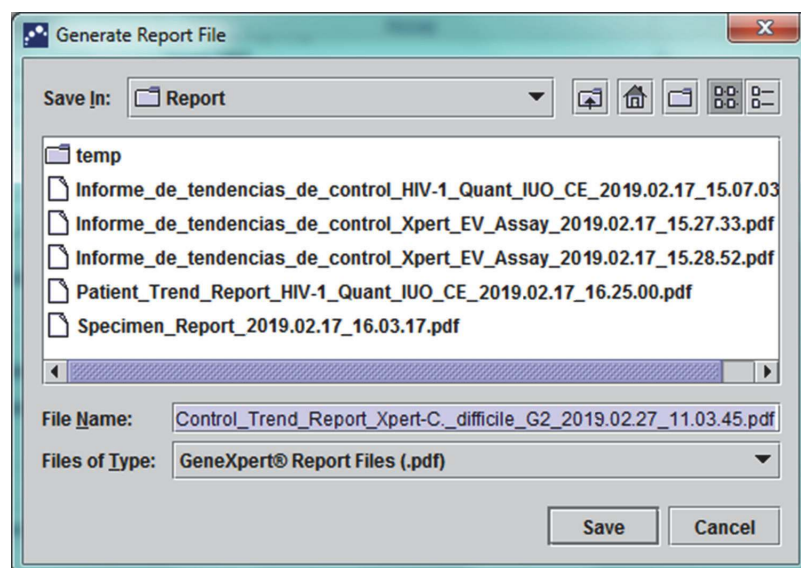

Figure 6-6. Generate Report File Dialog Box

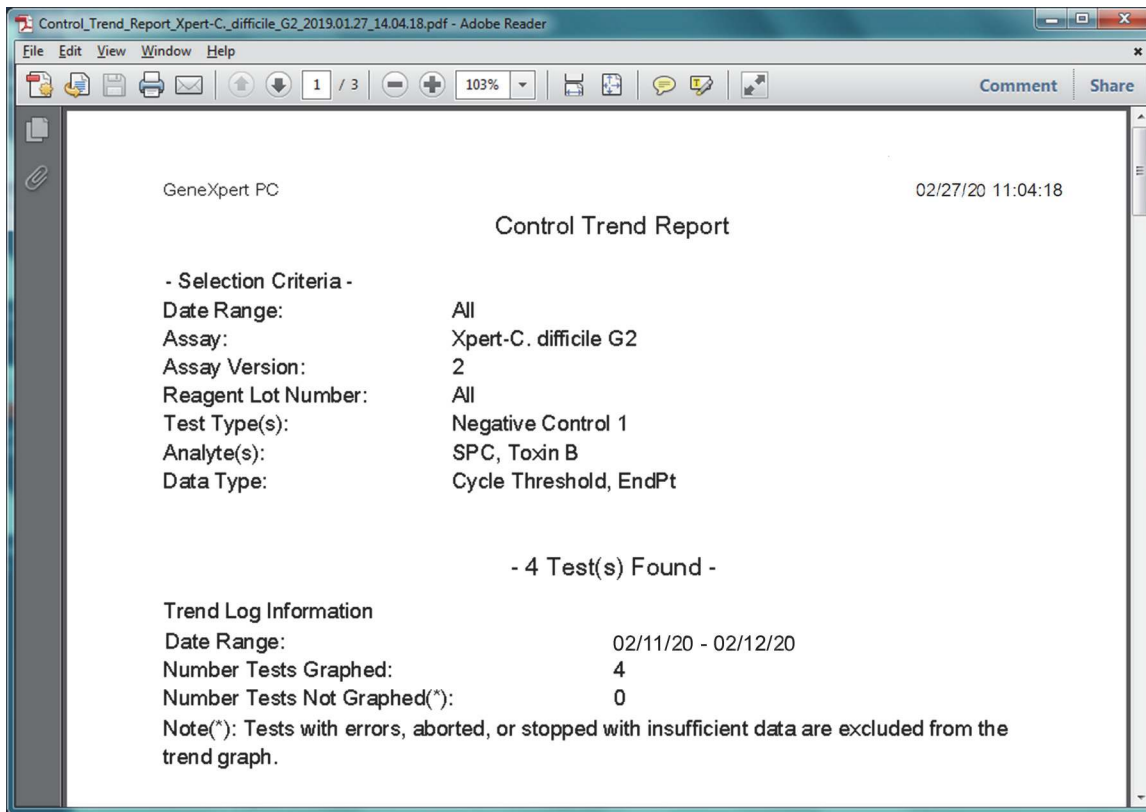

Figure 6-7. Example Control Trend Report in the Adobe Reader Window

The file from Adobe Reader may be saved in the Report folder or saved on another device.

A sample control trend report for a qualitative assay (Xpert C. difficile G2) is shown in [Figure 6-8](#) and [Figure 6-9](#). A sample control trend report for a quantitative assay (Xpert HIV-1 Viral Load) is shown in [Figure 6-10](#) and [Figure 6-11](#).

Note The Xpert HIV-1 Viral Load test is not available in the United States.

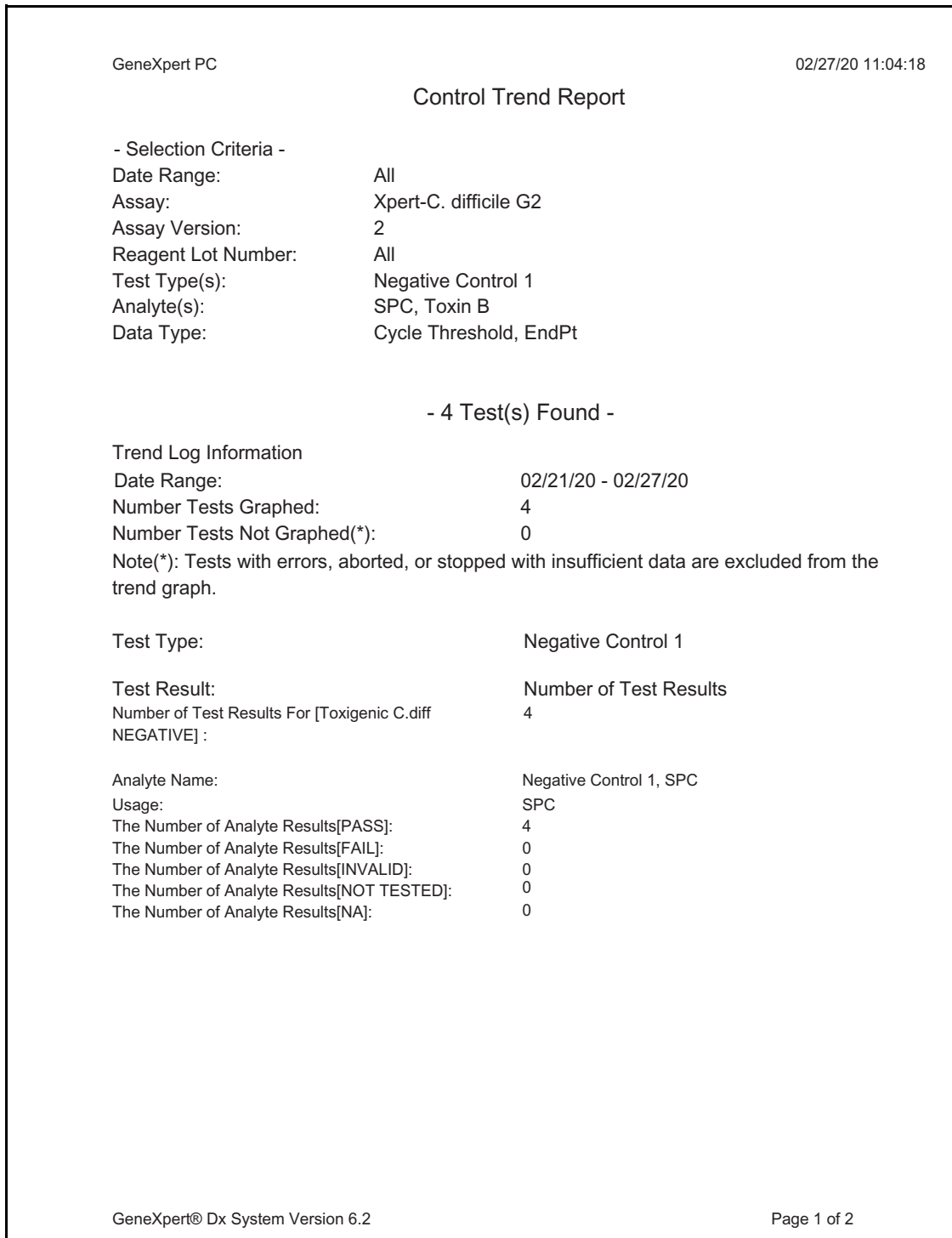

Figure 6-8. Control Trend Report Qualitative Assay Example (C. difficile G2), Page 1

Note The Control Trend Report will show Ct=0 as “out of scale”.

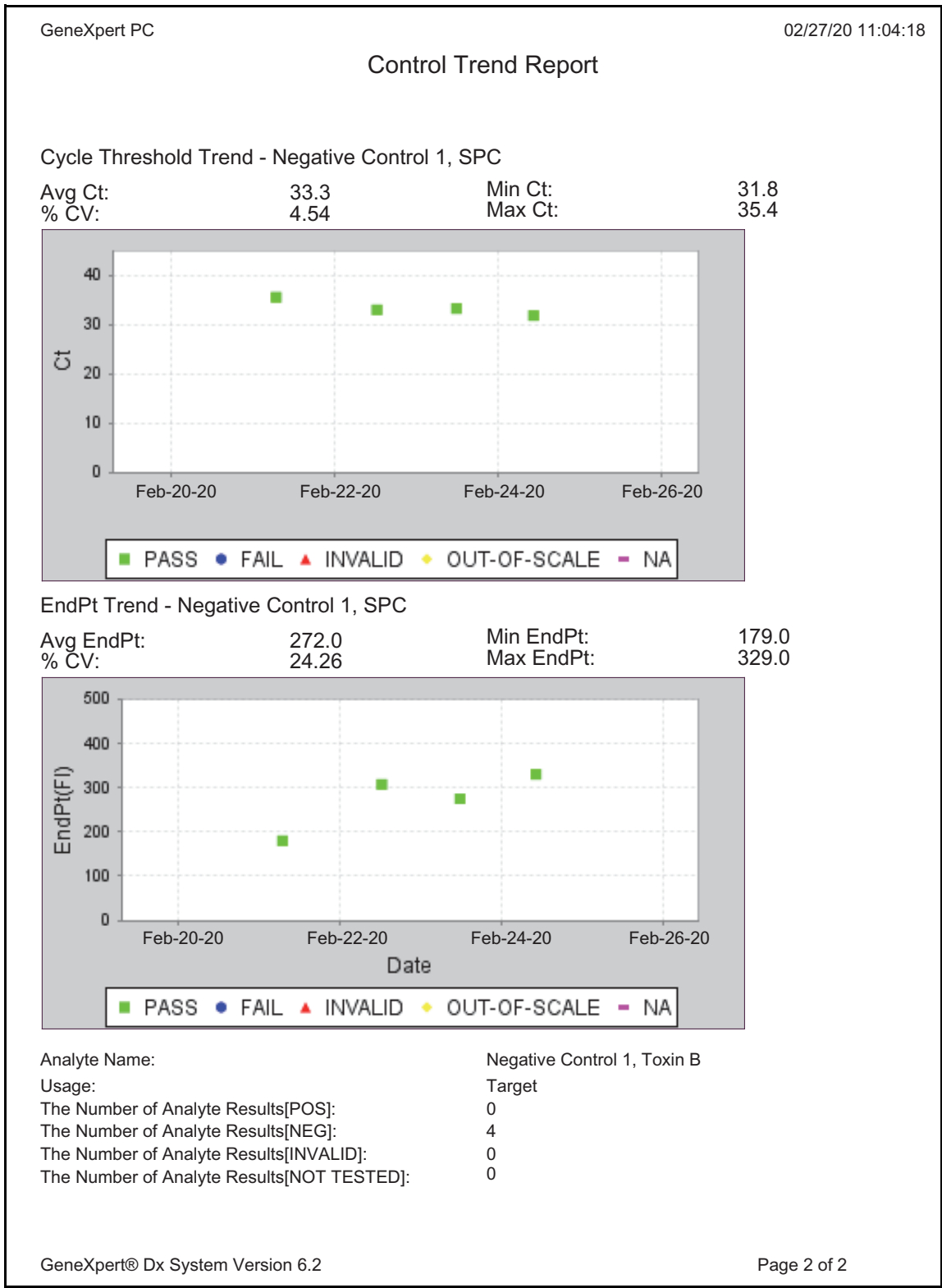

Figure 6-9. Control Trend Report Qualitative Assay Example (C. difficile G2) Page 2

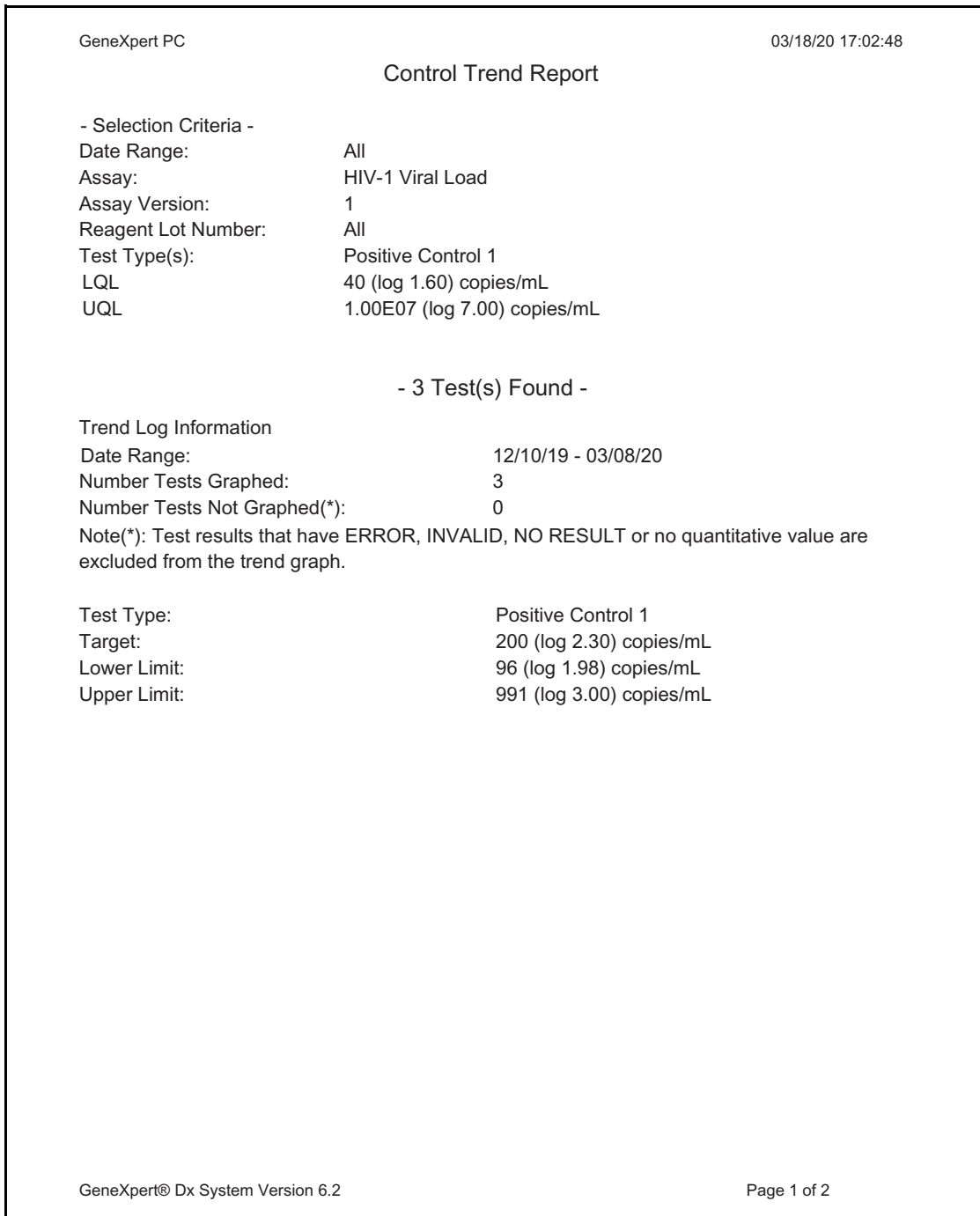

Figure 6-10. Control Trend Report Quantitative Assay Example (HIV-1 Viral Load), Page 1

Note The Xpert HIV-1 Viral Load test is not available in the United States.

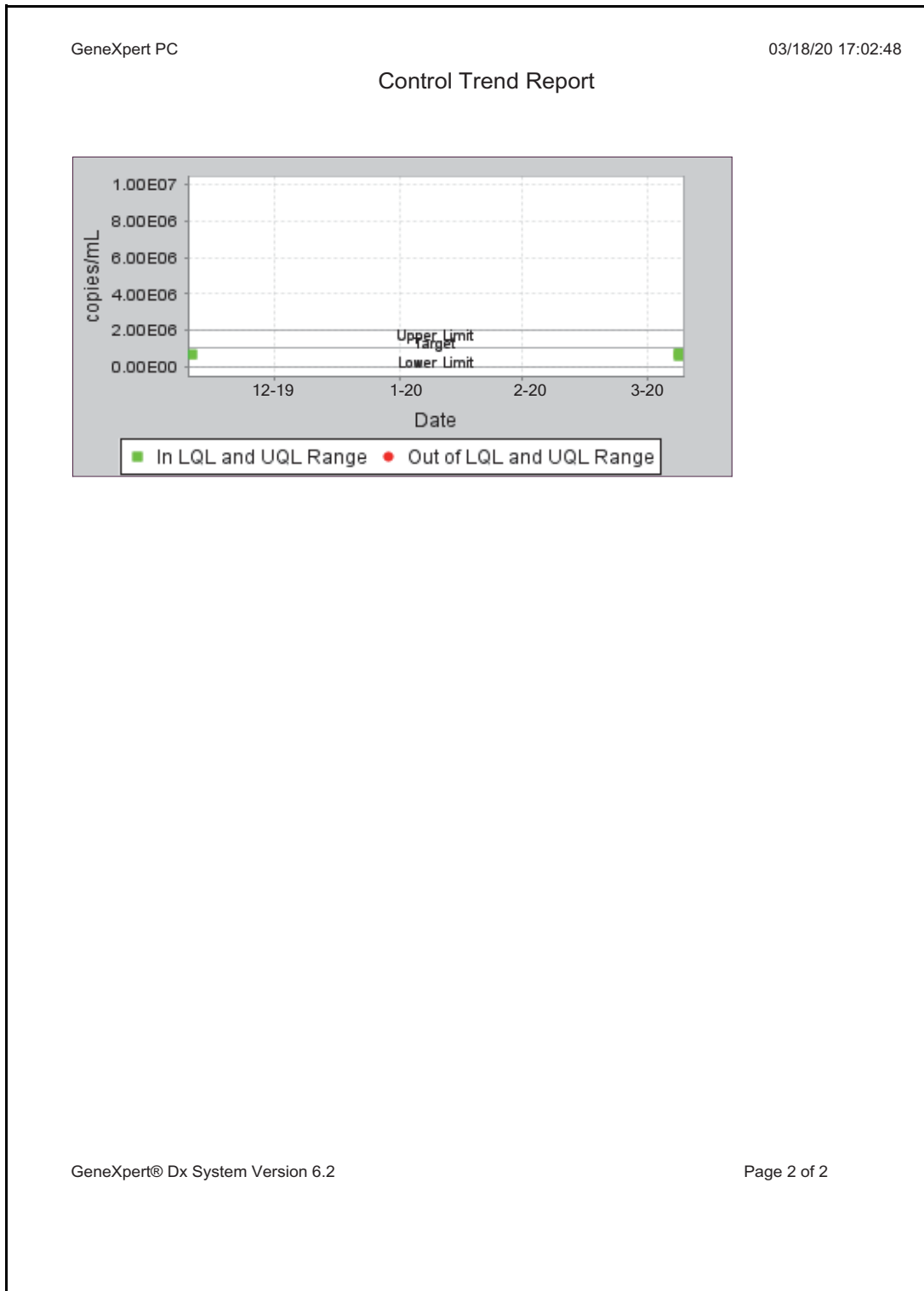

Figure 6-11. Control Trend Report Quantitative Assay Example (HIV-1 Viral Load), Page 2

Note

The Xpert HIV-1 Viral Load test is not available in the United States.

7 Operational Precautions and Limitations

You should be aware of the following system precautions and limitations to ensure proper operation and results:

- [Section 7.1, Security Precautions](#)
- [Section 7.2, Laboratory](#)
- [Section 7.3, Instrument and Software](#)
- [Section 7.4, Assay](#)
- [Section 7.5, Cartridge](#)

7.1 Security Precautions

User data stored in the system may contain personal health information of patients, such as name, patient ID, and test results. Cepheid strongly recommends that you implement physical, technical, and administrative safeguards to protect the privacy and integrity of patient data, such as restricting network and system access, enforcing user authentication practices, maintaining antiviral software, and so on, in accordance with applicable data privacy laws and regulations. In particular, unique, strong passwords should be maintained for all system users and should not be disabled. Consult your facilities security officer to ensure internal compliance with all applicable laws and regulations.

7.2 Laboratory

Before installing the GeneXpert Dx system, make sure your laboratory meets the environmental requirements specified in [Chapter 4, Performance Characteristics and Specifications](#).

- Place the GeneXpert Dx system in a sheltered environment because it is designed for indoor use only.
- Provide at least 5 cm (2 in) of clearance on each side of the GeneXpert instrument to ensure adequate ventilation.
- Do not place the GeneXpert instrument close to the vents of other instruments or air handling units.

7.3 Instrument and Software

Be sure to do the following:

- If an uninterruptible power supply (UPS) is used, connect the GeneXpert Dx system to an uninterruptible power supply (UPS) and a properly grounded AC circuit. See [Chapter 4, Performance Characteristics and Specifications](#) for the electrical requirements.
- Use the GeneXpert Dx system for *in vitro* diagnostic applications only.
- While a test is in progress:
 - Do not move the instrument.
 - Do not run other software.
 - Do not change the date and time.
 - Do not log out from the operating system.
 - Do not change the operating system account's password.
 - Do not update the antivirus software or run a scan.
 - Do not run Windows updates.

7.4 Assay

For each test, be sure to follow the instructions in the assay-specific package insert, which specifies the test requirements.

7.5 Cartridge



The GeneXpert cartridges are designed for single-use only. To prevent cross-contamination and biologically hazardous situations, use each cartridge only once.

Important

If module communication loss occurs after a test has been ordered and assigned to a module, but before the cartridge is loaded and the door is latched, an error message will appear that advises not to proceed with loading the cartridge and latching the door. If the message instructions are followed, the cartridge may be resubmitted to another module. However, if the cartridge is loaded and the door latched when module communication loss occurs, no result will be given when the test completes and the cartridge should not be reused.

8 Hazards

This chapter describes the possible safety hazards found in the GeneXpert Dx system. It is imperative that you follow the precautions in this chapter for safe operation. The topics are as follows:

- [Section 8.1, General Safety Precautions](#)
- [Section 8.2, Precautionary Statements Used in this Manual](#)
- [Section 8.3, Moving the Instrument](#)
- [Section 8.4, Safety Labels on the Instrument](#)
- [Section 8.5, Laser Safety](#)
- [Section 8.6, Electrical Safety](#)
- [Section 8.7, Chemical Safety](#)
- [Section 8.8, Biological Hazard Safety](#)
- [Section 8.9, Environmental Data](#)

8.1 General Safety Precautions

Before starting to use the GeneXpert Dx system, read this operator manual entirely and be familiar with the safety information provided. Using controls, making adjustments, or performing procedures other than those specified in this manual can result in exposure to hazards that can cause injury to personnel or damage to the system.

Protection provided by the equipment may be impaired if the equipment is used with accessories not provided or recommended by the manufacturer, or used in a manner not specified by the manufacturer. Do not use the equipment in hazardous atmospheres or with hazardous materials for which the equipment is not designed.

8.2 Precautionary Statements Used in this Manual

There are a number of safety notations used in the manual to identify potential safety hazards when operating or servicing the instrument. The types of precautionary statements used in this manual are:

Warning



A warning indicates a possibility of adverse reactions, injury, or death to the user or other personnel if the precautions or instructions are not observed.

Caution



A caution indicates that damage to the system, or invalid results could occur if the user fails to comply with the advice provided.

Important

Important indicators highlight information that is critical for the completion of a task or the optimal performance of the system.

Note

A note identifies information that applies only to specific cases or tasks.

The following warnings are used in this manual:

Biological Risks



A biological risk warning indicates that it is possible for personnel or the instrument to be exposed to biological hazards. Follow the instructions in the manual and use standard lab biological hazard protocol to reduce the possibility of exposure.

Warning



An electrical hazard warning indicates that there is a risk of electrical shock that can cause injury or death to the user or other personnel. Follow the instructions in the manual and use appropriate electrical precautions to avoid electrical shock. Operators should not attempt to open or remove the instrument covers. Doing so can expose them to electrical hazards.

Warning



A general warning indicates a hazard for which there are no standard icons provided in the manual. These warnings are accompanied by additional information about the hazard and how to avoid the hazard in the manual.

Warning



A heavy object warning indicates an object is heavy and that it is possible for personnel to be injured if they lift improperly. Follow instructions and observe proper lifting techniques or use lifting aids when lifting heavy objects.

Warning



This type of warning label indicates that the area contains a Class 2 laser and is located on the barcode scanner. Class 2 lasers are safe under reasonably foreseeable conditions of operation, including the use of optical instruments for intra-beam viewing. Do not stare into the laser beam.

The following cautions are used in this manual:

Caution



A general caution indicates a possibility of equipment damage for which there are no standard icons provided in the manual. These cautions are accompanied by additional information about how to avoid the equipment damage in the manual.

Caution



A data loss caution indicates a possibility of loss of data or data corruption if proper procedures are not followed. This caution will be accompanied by additional information about how to avoid the data loss in the manual.

8.3 Moving the Instrument

Because of the GeneXpert GX-XVI instrument's weight (see Weight in [Section 4.2, General Specifications](#)), do not attempt to lift the instrument without proper safety training and assistance. The weight of the GeneXpert GX-I, GeneXpert GX-II, and GeneXpert GX-IV is not a hazard under normal conditions.

Warning



Lifting or moving the GeneXpert GX-XVI instrument without proper training and assistance can cause personal injury or damage the instrument.

8.4 Safety Labels on the Instrument



[Table 8-1](#) lists the electrical labels that may be found on the GeneXpert instruments.

Table 8-1. Electrical Safety Labels on the Instruments

Label	Description
	Indicates the ON position of the main power switch.
○	Indicates the OFF position of the main power switch.
~	Indicates the designated terminal either receives or delivers alternating current or voltage.

[Table 8-2](#) lists other safety labels that may be found on the GeneXpert instruments.

Table 8-2. Other Safety Labels on the Instruments

Label	Description
	Indicates a potential hazard that is not defined by other warning labels. Consult the operator or service manual for further information or additional information that may be included on the label. Proceed with appropriate caution.
	Indicates a potential biological risk. Biological samples such as tissues, body fluids, and blood of humans and other animals have the potential to transmit infectious diseases. Follow your local, state/provincial, and national safety regulations for handling and disposing the samples.
	Indicates that there should be separate collection for electrical and electronic waste per Directive 2002/96/EC in the European Union. Follow your local state/provincial and national environmental regulations for disposing of electrical and electronic waste.

8.5 Laser Safety



The GeneXpert Dx systems use a Class 2 laser for the barcode scanner. The laser radiation symbol indicates that there can be laser light in the area. Take precautions to prevent exposure.

Do not stare into the laser beam.

8.6 Electrical Safety

Warning



Electrical hazards exist inside the GeneXpert instruments. Operators should not attempt to remove the instrument covers. Doing so can expose them to electrical hazards and cause injuries or death.

The GeneXpert instrument's enclosure is designed to protect operators from electrical shock hazards. Under normal operating conditions, you are protected from electrical shock hazards.

Only trained service personnel should open the covers of the GeneXpert instruments. Training is available from Cepheid.

8.7 Chemical Safety

- Follow standard laboratory safety procedures for working with chemicals.
- Biological specimens, transfer devices, and used cartridges should be considered capable of transmitting infectious agents requiring standard precautions. Follow your institution's environmental waste procedures for proper disposal of used cartridges and unused reagents. These materials may exhibit characteristics of chemical hazardous waste requiring specific national or regional disposal procedures. If national or regional regulations do not provide clear direction on proper disposal, biological specimens and used cartridges should be disposed per WHO (World Health Organization) medical waste handling and disposal guidelines.
- Safety Data Sheets (SDS) for all reagents used with this system are available upon request from Cepheid Technical Support and are available on Cepheid's websites (www.cepheid.com and www.cepheidinternational.com).
- Refer to the Cepheid website for additional environmental health and safety information on Cepheid products.

8.8 Biological Hazard Safety



Biological specimens, transfer devices, and used cartridges should be considered capable of transmitting infectious agents requiring standard precautions. Follow your institution's environmental waste procedures for proper disposal of used cartridges and unused reagents. These materials may exhibit characteristics of chemical hazardous waste requiring specific national or regional disposal procedures. If country or regional regulations do not provide clear direction on proper disposal, biological specimens and used cartridges should be disposed per WHO [World Health Organization] medical waste handling and disposal guidelines.

8.9 Environmental Data

- Recyclability of GeneXpert System: the WEEE mark is affixed to Cepheid electronic products.
- Recyclability of packaging materials: many of the shipping packaging components can be recycled.
- Additional information on the above, including EU and country directives concerning packaging, energy consumption, RoHS, REACH, Prop. 65, etc. can be found on the Cepheid website.

9 Service and Maintenance

This chapter describes the basic maintenance procedures for the GeneXpert instruments and lists the possible problems or error messages you might encounter. The topics in this chapter are as follows:

- Section 9.1, Maintenance Tasks
- Section 9.2, Maintenance Log
- Section 9.3, Power Down the System
- Section 9.4, Guidelines for Cleaning and Disinfecting
- Section 9.5, Cleaning the Work Area
- Section 9.6, Close Module Doors
- Section 9.7, Discard Used Cartridges
- Section 9.8, Cleaning the Instrument Surfaces
- Section 9.9, Cleaning the Plunger Rods and Cartridge Bays
- Section 9.10, Cleaning the I-CORE
- Section 9.11, Cleaning and Replacing the Fan Filters
- Section 9.12, Annual Instrument Maintenance
- Section 9.13, Using Module Reporters
- Section 9.14, Performing a Manual Self-Test
- Section 9.15, Excluding Modules from Test
- Section 9.16, Generating the System Log Report
- Section 9.17, Replacing Instrument Parts
- Section 9.18, Repairing the Instrument
- Section 9.19, Troubleshooting

9.1 Maintenance Tasks

Although the system is designed to prevent cross-contamination and ensure accurate results, the instrument can be checked and cleaned periodically as a precautionary measure. [Table 9-1](#) lists the basic maintenance tasks that can be performed.

Table 9-1. Maintenance Tasks and Frequency

Task	Frequency*	Section
Clean work area	Daily	Section 9.5
Close all module doors	Daily	Section 9.6
Discard used cartridges	Daily	Section 9.7
Power down the GeneXpert instrument	Weekly	Section 9.3
Power down the GeneXpert computer	Weekly	Section 9.3
Clean Fan PreFilters	Weekly	Section 9.11.2
Archive tests	Monthly	Section 5.16.1
Purge tests	Monthly	Section 5.18
Clean I-CORE using I-CORE brush	Monthly	Section 9.10
Clean plunger rod and cartridge bay	Quarterly	Section 9.9
Clean the instrument surfaces	Quarterly	Section 9.8
Replace fan filters	Quarterly	Section 9.11.2
Perform annual instrument maintenance	Annually	Section 9.12
Print system log report	As necessary	Section 9.16
Back up database	As necessary	Section 5.17.1

*Maintenance procedures may be performed more frequently according to your environmental conditions.

9.2 Maintenance Log

Complete the maintenance log shown in [Figure 9-1](#) daily or whenever maintenance tasks are performed on the system. Copies of this monthly log may be made to use, as required. There is an electronic version of this file on the *GeneXpert Dx System Operator Manual* CDROM that can be copied and used for monthly records. The electronic version of this file is a pdf file that can be filled in and saved using Adobe Reader or Adobe Acrobat.

GeneXpert® System Maintenance Log

Name of Institution:

GeneXpert Serial Number:

Month and Year:

Last Calibration Check Date:

FAS Installation Date:

Instructions: 1. Enter the name of your institution, GeneXpert Serial Number, current Month and Year, Last Calibration Check date, and FAS Installation Date in the fields above.
 2. For each maintenance activity listed below check the box(es) under the day of the month that the activities were performed and enter your initials (2 characters maximum) in the bottom row.
 3. Save the file after entering the data. We recommend saving one file each month for a complete record of activities.

	1	2	3	4	5	6	7	8	9	10	11	12	13	14	15	16	17	18	19	20	21	22	23	24	25	26	27	28	29	30	31	
Daily Maintenance																																
Clean work area	<input type="checkbox"/>	<input type="checkbox"/>	<input type="checkbox"/>	<input type="checkbox"/>	<input type="checkbox"/>	<input type="checkbox"/>	<input type="checkbox"/>	<input type="checkbox"/>	<input type="checkbox"/>	<input type="checkbox"/>	<input type="checkbox"/>	<input type="checkbox"/>	<input type="checkbox"/>	<input type="checkbox"/>	<input type="checkbox"/>	<input type="checkbox"/>	<input type="checkbox"/>	<input type="checkbox"/>	<input type="checkbox"/>	<input type="checkbox"/>	<input type="checkbox"/>	<input type="checkbox"/>	<input type="checkbox"/>	<input type="checkbox"/>	<input type="checkbox"/>	<input type="checkbox"/>	<input type="checkbox"/>	<input type="checkbox"/>	<input type="checkbox"/>	<input type="checkbox"/>	<input type="checkbox"/>	<input type="checkbox"/>
Close all module doors	<input type="checkbox"/>	<input type="checkbox"/>	<input type="checkbox"/>	<input type="checkbox"/>	<input type="checkbox"/>	<input type="checkbox"/>	<input type="checkbox"/>	<input type="checkbox"/>	<input type="checkbox"/>	<input type="checkbox"/>	<input type="checkbox"/>	<input type="checkbox"/>	<input type="checkbox"/>	<input type="checkbox"/>	<input type="checkbox"/>	<input type="checkbox"/>	<input type="checkbox"/>	<input type="checkbox"/>	<input type="checkbox"/>	<input type="checkbox"/>	<input type="checkbox"/>	<input type="checkbox"/>	<input type="checkbox"/>	<input type="checkbox"/>	<input type="checkbox"/>	<input type="checkbox"/>	<input type="checkbox"/>	<input type="checkbox"/>	<input type="checkbox"/>	<input type="checkbox"/>	<input type="checkbox"/>	<input type="checkbox"/>
Discard used cartridges	<input type="checkbox"/>	<input type="checkbox"/>	<input type="checkbox"/>	<input type="checkbox"/>	<input type="checkbox"/>	<input type="checkbox"/>	<input type="checkbox"/>	<input type="checkbox"/>	<input type="checkbox"/>	<input type="checkbox"/>	<input type="checkbox"/>	<input type="checkbox"/>	<input type="checkbox"/>	<input type="checkbox"/>	<input type="checkbox"/>	<input type="checkbox"/>	<input type="checkbox"/>	<input type="checkbox"/>	<input type="checkbox"/>	<input type="checkbox"/>	<input type="checkbox"/>	<input type="checkbox"/>	<input type="checkbox"/>	<input type="checkbox"/>	<input type="checkbox"/>	<input type="checkbox"/>	<input type="checkbox"/>	<input type="checkbox"/>	<input type="checkbox"/>	<input type="checkbox"/>	<input type="checkbox"/>	<input type="checkbox"/>
Weekly Maintenance																																
Power down the GeneXpert computer and instrument ¹	<input type="checkbox"/>	<input type="checkbox"/>	<input type="checkbox"/>	<input type="checkbox"/>	<input type="checkbox"/>	<input type="checkbox"/>	<input type="checkbox"/>	<input type="checkbox"/>	<input type="checkbox"/>	<input type="checkbox"/>	<input type="checkbox"/>	<input type="checkbox"/>	<input type="checkbox"/>	<input type="checkbox"/>	<input type="checkbox"/>	<input type="checkbox"/>	<input type="checkbox"/>	<input type="checkbox"/>	<input type="checkbox"/>	<input type="checkbox"/>	<input type="checkbox"/>	<input type="checkbox"/>	<input type="checkbox"/>	<input type="checkbox"/>	<input type="checkbox"/>	<input type="checkbox"/>	<input type="checkbox"/>	<input type="checkbox"/>	<input type="checkbox"/>	<input type="checkbox"/>	<input type="checkbox"/>	<input type="checkbox"/>
Clean Fan Prefilters	<input type="checkbox"/>	<input type="checkbox"/>	<input type="checkbox"/>	<input type="checkbox"/>	<input type="checkbox"/>	<input type="checkbox"/>	<input type="checkbox"/>	<input type="checkbox"/>	<input type="checkbox"/>	<input type="checkbox"/>	<input type="checkbox"/>	<input type="checkbox"/>	<input type="checkbox"/>	<input type="checkbox"/>	<input type="checkbox"/>	<input type="checkbox"/>	<input type="checkbox"/>	<input type="checkbox"/>	<input type="checkbox"/>	<input type="checkbox"/>	<input type="checkbox"/>	<input type="checkbox"/>	<input type="checkbox"/>	<input type="checkbox"/>	<input type="checkbox"/>	<input type="checkbox"/>	<input type="checkbox"/>	<input type="checkbox"/>	<input type="checkbox"/>	<input type="checkbox"/>	<input type="checkbox"/>	<input type="checkbox"/>
Monthly Maintenance																																
Archive tests ²	<input type="checkbox"/>	<input type="checkbox"/>	<input type="checkbox"/>	<input type="checkbox"/>	<input type="checkbox"/>	<input type="checkbox"/>	<input type="checkbox"/>	<input type="checkbox"/>	<input type="checkbox"/>	<input type="checkbox"/>	<input type="checkbox"/>	<input type="checkbox"/>	<input type="checkbox"/>	<input type="checkbox"/>	<input type="checkbox"/>	<input type="checkbox"/>	<input type="checkbox"/>	<input type="checkbox"/>	<input type="checkbox"/>	<input type="checkbox"/>	<input type="checkbox"/>	<input type="checkbox"/>	<input type="checkbox"/>	<input type="checkbox"/>	<input type="checkbox"/>	<input type="checkbox"/>	<input type="checkbox"/>	<input type="checkbox"/>	<input type="checkbox"/>	<input type="checkbox"/>	<input type="checkbox"/>	<input type="checkbox"/>
Purge tests ²	<input type="checkbox"/>	<input type="checkbox"/>	<input type="checkbox"/>	<input type="checkbox"/>	<input type="checkbox"/>	<input type="checkbox"/>	<input type="checkbox"/>	<input type="checkbox"/>	<input type="checkbox"/>	<input type="checkbox"/>	<input type="checkbox"/>	<input type="checkbox"/>	<input type="checkbox"/>	<input type="checkbox"/>	<input type="checkbox"/>	<input type="checkbox"/>	<input type="checkbox"/>	<input type="checkbox"/>	<input type="checkbox"/>	<input type="checkbox"/>	<input type="checkbox"/>	<input type="checkbox"/>	<input type="checkbox"/>	<input type="checkbox"/>	<input type="checkbox"/>	<input type="checkbox"/>	<input type="checkbox"/>	<input type="checkbox"/>	<input type="checkbox"/>	<input type="checkbox"/>	<input type="checkbox"/>	<input type="checkbox"/>
Clean I-CORE Using I-CORE ³ cleaning brush	<input type="checkbox"/>	<input type="checkbox"/>	<input type="checkbox"/>	<input type="checkbox"/>	<input type="checkbox"/>	<input type="checkbox"/>	<input type="checkbox"/>	<input type="checkbox"/>	<input type="checkbox"/>	<input type="checkbox"/>	<input type="checkbox"/>	<input type="checkbox"/>	<input type="checkbox"/>	<input type="checkbox"/>	<input type="checkbox"/>	<input type="checkbox"/>	<input type="checkbox"/>	<input type="checkbox"/>	<input type="checkbox"/>	<input type="checkbox"/>	<input type="checkbox"/>	<input type="checkbox"/>	<input type="checkbox"/>	<input type="checkbox"/>	<input type="checkbox"/>	<input type="checkbox"/>	<input type="checkbox"/>	<input type="checkbox"/>	<input type="checkbox"/>	<input type="checkbox"/>	<input type="checkbox"/>	<input type="checkbox"/>
Quarterly Maintenance																																
Clean plunger rod and cartridge bays ¹	<input type="checkbox"/>	<input type="checkbox"/>	<input type="checkbox"/>	<input type="checkbox"/>	<input type="checkbox"/>	<input type="checkbox"/>	<input type="checkbox"/>	<input type="checkbox"/>	<input type="checkbox"/>	<input type="checkbox"/>	<input type="checkbox"/>	<input type="checkbox"/>	<input type="checkbox"/>	<input type="checkbox"/>	<input type="checkbox"/>	<input type="checkbox"/>	<input type="checkbox"/>	<input type="checkbox"/>	<input type="checkbox"/>	<input type="checkbox"/>	<input type="checkbox"/>	<input type="checkbox"/>	<input type="checkbox"/>	<input type="checkbox"/>	<input type="checkbox"/>	<input type="checkbox"/>	<input type="checkbox"/>	<input type="checkbox"/>	<input type="checkbox"/>	<input type="checkbox"/>	<input type="checkbox"/>	<input type="checkbox"/>
Clean instrument surfaces ¹	<input type="checkbox"/>	<input type="checkbox"/>	<input type="checkbox"/>	<input type="checkbox"/>	<input type="checkbox"/>	<input type="checkbox"/>	<input type="checkbox"/>	<input type="checkbox"/>	<input type="checkbox"/>	<input type="checkbox"/>	<input type="checkbox"/>	<input type="checkbox"/>	<input type="checkbox"/>	<input type="checkbox"/>	<input type="checkbox"/>	<input type="checkbox"/>	<input type="checkbox"/>	<input type="checkbox"/>	<input type="checkbox"/>	<input type="checkbox"/>	<input type="checkbox"/>	<input type="checkbox"/>	<input type="checkbox"/>	<input type="checkbox"/>	<input type="checkbox"/>	<input type="checkbox"/>	<input type="checkbox"/>	<input type="checkbox"/>	<input type="checkbox"/>	<input type="checkbox"/>	<input type="checkbox"/>	<input type="checkbox"/>
Replace fan filters ¹	<input type="checkbox"/>	<input type="checkbox"/>	<input type="checkbox"/>	<input type="checkbox"/>	<input type="checkbox"/>	<input type="checkbox"/>	<input type="checkbox"/>	<input type="checkbox"/>	<input type="checkbox"/>	<input type="checkbox"/>	<input type="checkbox"/>	<input type="checkbox"/>	<input type="checkbox"/>	<input type="checkbox"/>	<input type="checkbox"/>	<input type="checkbox"/>	<input type="checkbox"/>	<input type="checkbox"/>	<input type="checkbox"/>	<input type="checkbox"/>	<input type="checkbox"/>	<input type="checkbox"/>	<input type="checkbox"/>	<input type="checkbox"/>	<input type="checkbox"/>	<input type="checkbox"/>	<input type="checkbox"/>	<input type="checkbox"/>	<input type="checkbox"/>	<input type="checkbox"/>	<input type="checkbox"/>	<input type="checkbox"/>
Yearly Maintenance																																
Check annual instrument maintenance ¹	<input type="checkbox"/>	<input type="checkbox"/>	<input type="checkbox"/>	<input type="checkbox"/>	<input type="checkbox"/>	<input type="checkbox"/>	<input type="checkbox"/>	<input type="checkbox"/>	<input type="checkbox"/>	<input type="checkbox"/>	<input type="checkbox"/>	<input type="checkbox"/>	<input type="checkbox"/>	<input type="checkbox"/>	<input type="checkbox"/>	<input type="checkbox"/>	<input type="checkbox"/>	<input type="checkbox"/>	<input type="checkbox"/>	<input type="checkbox"/>	<input type="checkbox"/>	<input type="checkbox"/>	<input type="checkbox"/>	<input type="checkbox"/>	<input type="checkbox"/>	<input type="checkbox"/>	<input type="checkbox"/>	<input type="checkbox"/>	<input type="checkbox"/>	<input type="checkbox"/>	<input type="checkbox"/>	<input type="checkbox"/>
As Necessary																																
Print system log report ¹	<input type="checkbox"/>	<input type="checkbox"/>	<input type="checkbox"/>	<input type="checkbox"/>	<input type="checkbox"/>	<input type="checkbox"/>	<input type="checkbox"/>	<input type="checkbox"/>	<input type="checkbox"/>	<input type="checkbox"/>	<input type="checkbox"/>	<input type="checkbox"/>	<input type="checkbox"/>	<input type="checkbox"/>	<input type="checkbox"/>	<input type="checkbox"/>	<input type="checkbox"/>	<input type="checkbox"/>	<input type="checkbox"/>	<input type="checkbox"/>	<input type="checkbox"/>	<input type="checkbox"/>	<input type="checkbox"/>	<input type="checkbox"/>	<input type="checkbox"/>	<input type="checkbox"/>	<input type="checkbox"/>	<input type="checkbox"/>	<input type="checkbox"/>	<input type="checkbox"/>	<input type="checkbox"/>	<input type="checkbox"/>
Back up database ²	<input type="checkbox"/>	<input type="checkbox"/>	<input type="checkbox"/>	<input type="checkbox"/>	<input type="checkbox"/>	<input type="checkbox"/>	<input type="checkbox"/>	<input type="checkbox"/>	<input type="checkbox"/>	<input type="checkbox"/>	<input type="checkbox"/>	<input type="checkbox"/>	<input type="checkbox"/>	<input type="checkbox"/>	<input type="checkbox"/>	<input type="checkbox"/>	<input type="checkbox"/>	<input type="checkbox"/>	<input type="checkbox"/>	<input type="checkbox"/>	<input type="checkbox"/>	<input type="checkbox"/>	<input type="checkbox"/>	<input type="checkbox"/>	<input type="checkbox"/>	<input type="checkbox"/>	<input type="checkbox"/>	<input type="checkbox"/>	<input type="checkbox"/>	<input type="checkbox"/>	<input type="checkbox"/>	<input type="checkbox"/>
Technician Initials (Two Letters)	<input type="text"/>	<input type="text"/>	<input type="text"/>	<input type="text"/>	<input type="text"/>	<input type="text"/>	<input type="text"/>	<input type="text"/>	<input type="text"/>	<input type="text"/>	<input type="text"/>	<input type="text"/>	<input type="text"/>	<input type="text"/>	<input type="text"/>	<input type="text"/>	<input type="text"/>	<input type="text"/>	<input type="text"/>	<input type="text"/>	<input type="text"/>	<input type="text"/>	<input type="text"/>	<input type="text"/>	<input type="text"/>	<input type="text"/>	<input type="text"/>	<input type="text"/>	<input type="text"/>	<input type="text"/>	<input type="text"/>	<input type="text"/>



1. Refer to Chapter 9 (Service and Maintenance) in the Operator Manual for detailed procedure.
 2. Refer to Chapter 5 (Operating Instructions) in the Operator Manual for detailed procedure.
 These are minimum recommendations for cleaning. Your institution may require that maintenance be performed on a more frequent basis.

Reference: GeneXpert GX Dx Operator Manual (P/N 302-0670, Rev. D)

Figure 9-1. Maintenance Log

9.3 Power Down the System

The GeneXpert instrument and computer should be powered down once per week to refresh the system. This action clears out unwanted temporary files and guards against computer memory corruption to prevent a malfunction of the system. To exit the GeneXpert Dx software, see [Section 5.2.5, Logging Off](#). Power down the computer, wait two minutes, then restart the computer.

Note

This action can be achieved during the cleaning or replacement of fan filters procedures, as described in section 9.11.

9.4 Guidelines for Cleaning and Disinfecting

Cleaning and disinfecting system components is crucial for proper system maintenance. Disinfection is a chemical reaction. As a chemical reaction, it is affected by many factors including the concentration of the disinfectant, contact time, temperature, nature of the microbes present, amount of organic residue, surface properties, etc. With any disinfectant, it is crucial that the entire area to be disinfected be in contact with the disinfecting solution.

Note

Maintenance procedures may be performed more frequently according to your environmental conditions.

General guidelines for routine surface cleaning are:

- Use only 70% ethanol or denatured ethanol (70% ethanol containing 5% methanol and 5% isopropanol).

General guidelines for cleaning combined with disinfection are:

- Use a final concentration of 1:10 dilution of household chlorine bleach (used within 1 day of preparation).

Note

Final active chlorine concentration should be 0.5% regardless of the household bleach concentration in your country.

- Use sufficient disinfectant (bleach solution) and spread the disinfectant evenly. The entire surface should be wet to completely disinfect the surface.
- Allow a minimum of two minutes contact time. More than eight minutes is not recommended.
- Remove remaining bleach residue with 70% ethanol or denatured ethanol (70% ethanol containing 5% methanol and 5% isopropanol).

Caution

Failure to remove bleach residue from the system may cause damage to the instrument components. Always perform a wipe down with ethanol after using bleach.

- Repeat the cleaning and disinfection with bleach three times (two minutes contact time for each bleach application) followed by a final wipe with ethanol to remove bleach residue.

Note

An optical brush may be used for extra cleaning depending on your environment. Please contact your local representative to determine if the optical brush cleaning procedure is required for your environmental conditions. If this procedure is required, you should request from your local representative a Technical Bulletin with instructions on how to perform this procedure as well as the optical brushes required to perform this procedure.

9.5 Cleaning the Work Area

Clean the work area daily using good laboratory practices to avoid contamination of specimens or reagents. Follow your institution's guidelines for cleaning the work area.

9.6 Close Module Doors

Check that all module doors are closed daily to avoid contamination of the modules.

9.7 Discard Used Cartridges

Discard used cartridges from the GeneXpert Dx system modules and on the surrounding work surfaces. Follow your institution's standard practices for disposal. See [Section 8.7, Chemical Safety](#) and [Section 8.8, Biological Hazard Safety](#) for additional information regarding cartridge disposal.

9.8 Cleaning the Instrument Surfaces

Clean the instrument surfaces quarterly (every three months) with ethanol. All outside surfaces of the instrument housing should be cleaned including the top, sides, and outside door of the module.

Before cleaning the instrument surfaces, read [Section 9.4, Guidelines for Cleaning and Disinfecting](#).

The materials required for this procedure are:

- 70% ethanol or denatured ethanol (70% ethanol containing 5% isopropanol and 5% methanol).

Caution



Do not use 70% isopropyl alcohol for cleaning the instrument surfaces. Isopropyl alcohol can degrade system components.

- A final concentration of 1:10 dilution of household chlorine bleach (used within 1 day of preparation).

Note

Final active chlorine concentration should be 0.5% regardless of the household bleach concentration in your country.

Important

Use the bleach solution only in the event of a spill. Wipe down the affected surface(s) with bleach three separate times. Leave the bleach on the instrument surfaces for two minutes each time before wiping the surfaces with ethanol to remove the bleach residue.

- Lint-free wipes
- Disposable gloves
- Eye protection

Biological Risks



Wear disposable gloves, eye protection and other personal protective equipment (PPE) mandated by your institution's safety policies while performing this cleaning procedure. Wearing PPE prevents exposure to chemical and biologically hazardous materials.

9.8.1 Quarterly Maintenance

Warning



Shut down the GeneXpert Dx system completely when cleaning the instrument surfaces.

Important

Do not remove the instrument covers or use a vacuum cleaner inside the instrument at any time. Remove debris from exterior instrument surfaces using lint-free wipes or paper towels moistened with ethanol or bleach as described in the following procedure.

For routine cleaning of the instrument surfaces:

1. Thoroughly moisten a lint-free wipe or paper towel with the 70% ethanol solution.
2. Wipe all surfaces outside the instrument. Change lint-free wipes or paper towels frequently while wiping.
3. Move the GeneXpert instrument and wipe the table surfaces underneath and around the instrument. Change lint-free wipes or paper towels frequently while wiping.
4. Discard used wipes or paper towels according to your standard laboratory procedure.

9.8.2 In Case of Spill

Clean affected exterior instrument surfaces in the event of a spill.

Important

If it is suspected that a spill has affected the interior of the instrument, do not remove any of the exterior instrument covers. Instead, shut down the instrument and contact Cepheid Technical Support for assistance.

To clean the affected instrument surfaces:

1. Thoroughly moisten a lint-free wipe or paper towel with the 1:10 bleach solution.
2. Wipe affected surfaces on the instrument. Change wipes or paper towels frequently while wiping.
3. Allow the bleach solution to remain on the surfaces at least two minutes but no longer than eight minutes.
4. Repeat [Step 1](#) through [Step 3](#) two more times for a total of three times.
5. Thoroughly moisten a lint-free wipe or paper towel with the 70% ethanol solution.
6. Wipe affected surfaces on the instrument. Change wipes or paper towels frequently while wiping.
7. Discard used wipes or paper towels according to your standard laboratory procedure.

9.9 Cleaning the Plunger Rods and Cartridge Bays

Clean and disinfect the plunger rods and cartridge bays quarterly (every three months), in the event of a spill, or if a negative control yields a positive result.

Before cleaning the plunger rods and cartridge bays, read [Section 9.4, Guidelines for Cleaning and Disinfecting](#).

The materials required for this procedure are:

- A final concentration of 1:10 dilution of household chlorine bleach (used within 1 day of preparation)

Important

Perform the bleach wipe-down three separate times on the interior surfaces of the cartridge bay, allowing the bleach to remain on the surfaces for two minutes after each wipe. After the final two minutes, remove the bleach residue by thoroughly wiping the cartridge bay and plunger rod with ethanol.

- 70% ethanol or denatured ethanol (70% ethanol containing 5% isopropanol and 5% methanol)

Caution



Do not use 70% isopropyl alcohol for cleaning the cartridge bay and plunger rod. Isopropyl alcohol can degrade polycarbonate plastics.

- Lint-free wipes
- Disposable gloves
- Eye protection

Biological Risks



Wear disposable gloves, eye protection and other personal protective equipment (PPE) mandated by your institution's safety policies while performing this cleaning procedure. Wearing PPE prevents exposure to chemical and biologically hazardous materials.

To clean the plunger rod(s) and cartridge bay(s):

1. Remove cartridge(s) from the module(s) to be cleaned.
2. In the GeneXpert Dx System window, click the **Maintenance** icon (see Figure 9-2). The **Maintenance** screen is displayed.
3. Click on **Maintenance** on the Menu Bar (see Figure 9-2), select **Plunger Rod Maintenance**. The **Plunger Rod Maintenance** dialog box is displayed. See Figure 9-3.

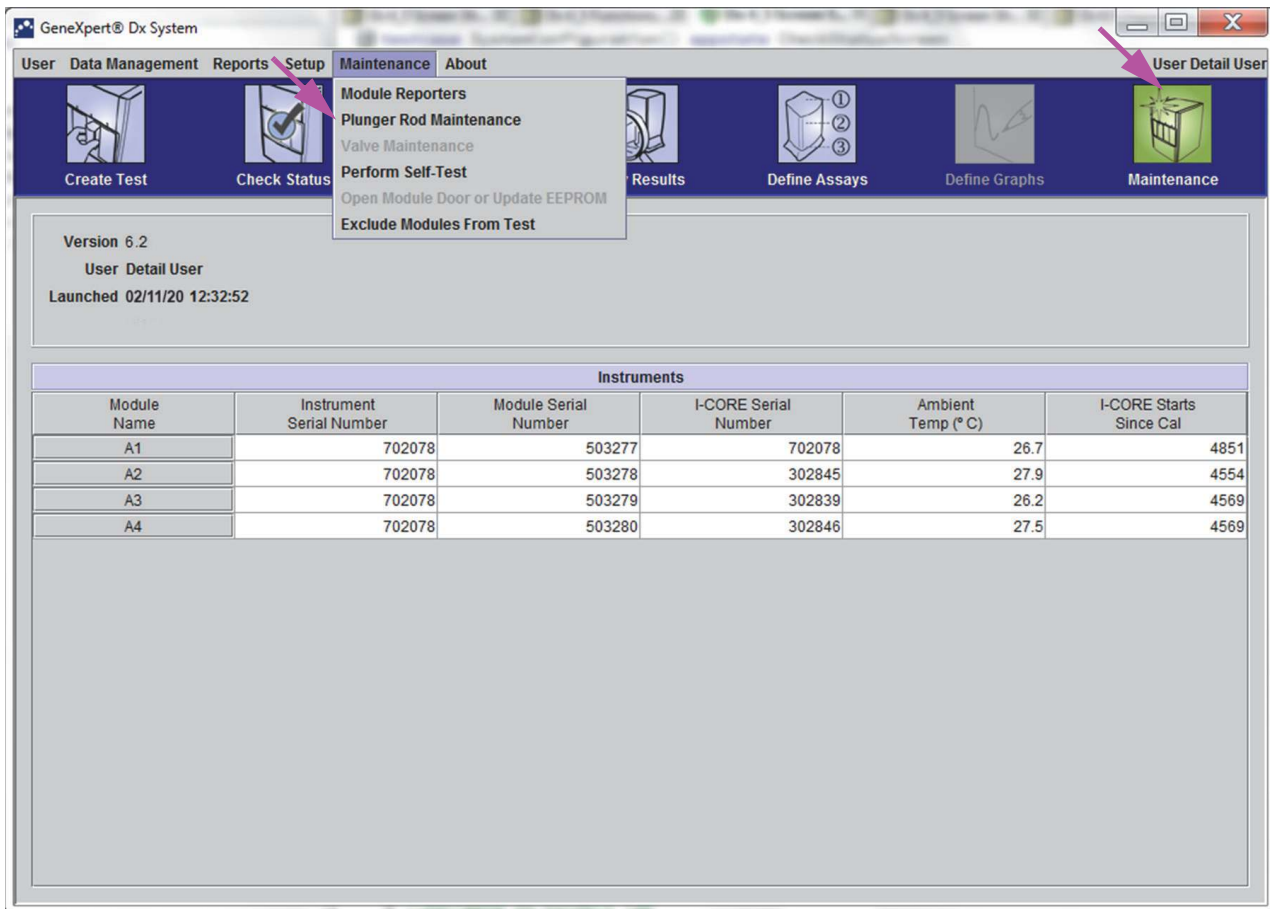

Figure 9-2. GeneXpert Dx System Window

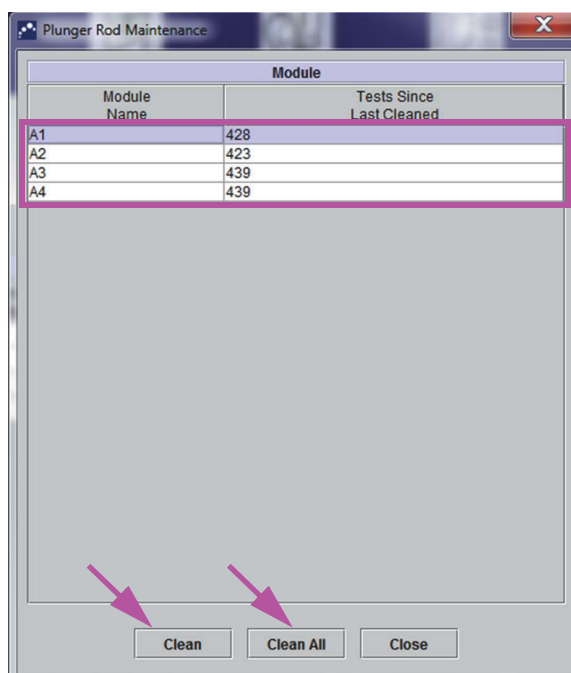

Figure 9-3. The Plunger Rod Maintenance Dialog Box

Note

For efficient cleaning of the cartridge bay(s) and plunger rod(s), choose the **Clean All** option, which lowers all plunger rod(s), allowing the cleaning of all modules simultaneously.

On the GeneXpert GX-XVI, for efficient cleaning of the cartridge bays and plunger rods, clean them in groups of four modules.

- In the **Module** table, select the module(s) to be cleaned and then select **Clean** or **Clean All** (see [Figure 9-3](#)). The Plunger Rod Cleaning dialog box is displayed (see [Figure 9-4](#)).

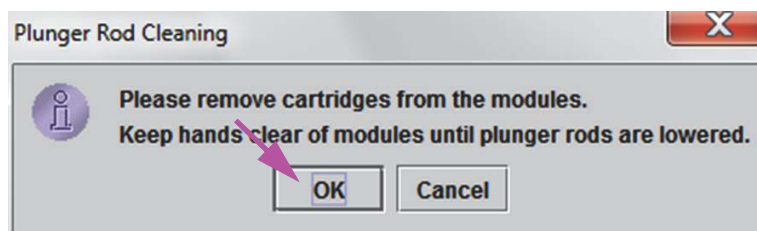

Figure 9-4. Plunger Rod Cleaning Dialog Box

- Ensure that there are no cartridges in any of the modules, and click **OK**.
- In the Plunger Rod Maintenance dialog box, the **Clean** button name changes to **Move Up** (if the **Clean All** button is clicked, it changes to **Move Up All**). In the instrument, the plunger rod(s) in the selected module(s) (or all modules if the **Clean All** button is clicked) lowers into the cartridge bay(s). See [Figure 9-5](#).

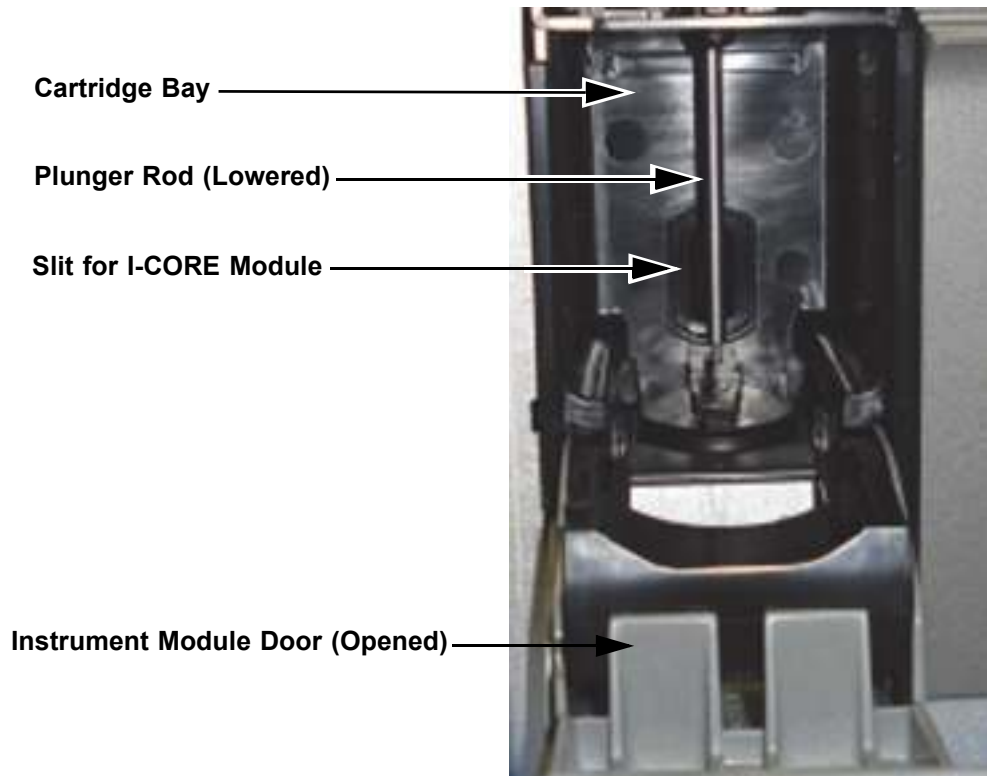

Figure 9-5. Plunger Rod Lowered into Cartridge Bay

7. Clean the plunger rod(s) and cartridge bay(s) as follows:
 - A. Thoroughly moisten a lint-free wipe with a 1:10 solution of household chlorine bleach.

Caution



Do not use a spray bottle to clean inside the cartridge bay. Getting bleach solution inside the I-CORE module can damage the module.

- B. Vigorously wipe the plunger rod with the lint-free wipe. Wipe hard enough to remove the black debris that accumulates on the plunger rod.
Using the same lint-free wipe, wipe the walls, ceiling, corners and edges of the cartridge bay, then wipe the inside of the door and the top lip of the door and discard the lint-free wipe.

Caution



Getting liquid inside the I-CORE module can damage the module. Do not touch the slit on the I-CORE module where the cartridge reaction tube is inserted (see [Figure 9-5](#)).

Caution



Do not allow the bleach to remain on any surface for more than eight minutes.

- C. Wait 2 minutes after wiping with the bleach solution.
 - D. Use a new lint-free wipe thoroughly moistened with the 1:10 bleach solution and wipe the plunger rod, walls, ceiling, corners and edges of the cartridge bay, then wipe the inside of the door and the top lip of the door and discard the wipe.
 - E. Wait 2 minutes after wiping with the bleach solution.
 - F. Using another new lint-free wipe thoroughly moistened with the 1:10 bleach solution, wipe the plunger rod, walls, ceiling, corners and edges of the cartridge bay. Wipe the inside of the door and the top lip of the door and discard the lint-free wipe.
 - G. Wait 2 minutes after wiping with the bleach solution.
 - H. Thoroughly moisten a lint-free wipe with the 70% ethanol solution.
 - I. Use the lint-free wipe thoroughly moistened with the 70% ethanol solution to remove all residual bleach. Wipe the plunger rod, walls, ceiling, corners and edges of the cartridge bay, then wipe the inside of the door and the top lip of the door and discard the lint-free wipe.
8. After the plunger rod(s) and cartridge bay(s) have been cleaned, return to the Plunger Maintenance dialog box and select the **Move Up** button. The plunger rod(s) move(s) back up to the resting position.
 9. Click **Close** to close the Plunger Maintenance dialog box.
 10. Manually close the instrument module door(s).

This completes the procedures for cleaning the plunger rod(s) and cartridge bay(s).

9.10 Cleaning the I-CORE

This I-CORE cleaning procedure should be performed monthly. This procedure describes the method for removing dust and tube debris from the surface of rod lenses of the excite and detect blocks for GeneXpert Dx modules.

Note

This procedure applies to both GeneXpert 6- and 10-color modules.

Materials Required or Recommended for Cleaning

- GX Cleaning Kit (700-6519)
- Disposable gloves

Estimated Cleaning Time: 30 Seconds per module.

9.10.1 Lens Cleaning Procedure

1. Select the module to be cleaned and manually open the door of the module.
2. If necessary, remove the cartridge from the module.

Biological Risks



Remove the cartridge from the GeneXpert modules prior to cleaning. Failure to remove a cartridge could result in personnel being exposed to biological hazards and/or liquid biological materials spilling into the instrument and causing damage to the instrument.

3. Locate the brush provided in the GX Cleaning kit (see [Figure 9-6](#)).

Nylon Bristles

Shank Insertion Shoulder

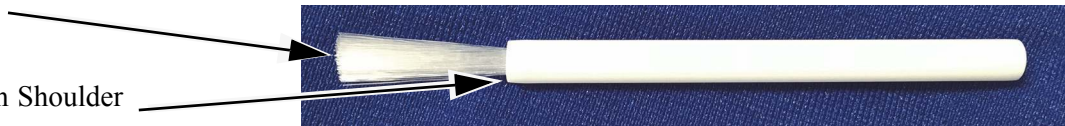

Figure 9-6. Lens Cleaning Brush (300-8330)

Note

The brush is designed so that it will easily insert into the I-CORE slit and make contact with the rod lenses of the excite and detect blocks.

Biological Risks



Make sure you wear disposable gloves for the cleaning process. Wearing gloves prevents you from being exposed to biologically hazardous materials.

4. Wearing disposable gloves, insert the brush into the I-CORE slit in a tilted manner up to the shank insertion shoulder, as shown in [Figure 9-7](#).

Note

Make sure that all the bristles are fully inserted (up to the shoulder of the plastic shank of the brush) so that it does not cause unnecessary damage to the brush.

Caution



Do not insert any objects into the I-CORE slit except the provided brush. Inserting any other object may damage the I-CORE.

Caution



Do not apply any solution (such as ethanol or bleach) onto the brush bristles. The brush must be completely dry when inserting it into the I-CORE slit.

Important

The brush is intended for single-use and should not be used on more than one module. Use a new brush for each module to be cleaned.

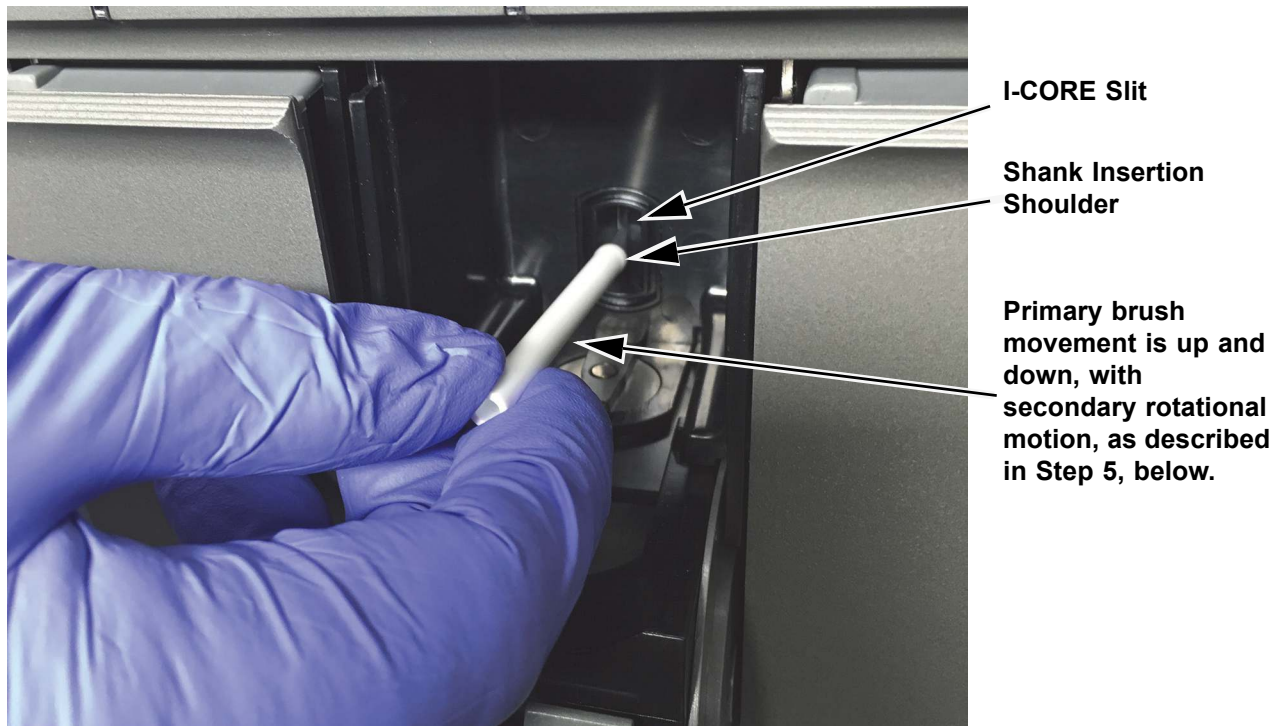

Figure 9-7. Inserting the Cleaning Brush into the I-CORE Slit

5. Insert the brush into the I-CORE slit completely up to the plastic shank (shoulder) of the brush. Hold the brush firmly in the I-CORE slit, and perform cleaning of the rod lenses as described below. The entire cleaning process should take approximately 30 seconds per module.

Note

Cleaning is done by moving the brush in an up and down direction within the I-CORE slit. Brush rotation, even if it has to be done, is not the main action that results in optics cleaning.

- A. Begin by brushing from the top of the I-CORE slit to the bottom, making sure to apply a uniform pressure when brushing from the top to the bottom of the I-CORE slit. This will ensure that most of the tube debris and dust is brushed off from the surface of the lenses.
 - B. Rotate the brush from left to right and back again, approximately 180°.
 - C. Brush once more from the top of the I-CORE slit to the bottom.
 - D. Rotate the brush again from left to right and back again, approximately 180°.
 - E. Finally, brush again from the top of the I-CORE slit to the bottom.
6. When lens cleaning is complete, remove and discard the used brush and gloves as hazardous waste.

Biological Risks



Dispose of gloves and brushes according to your institution's safety policies and procedures for hazardous waste.

9.11 Cleaning and Replacing the Fan Filters

9.11.1 GX-II and GX-IV Fan Filters

There are two styles of fan filters on the GeneXpert GX-II and GeneXpert GX-IV instruments. If the GeneXpert instrument has a rear panel such as the ones shown in [Figure 9-8](#), the fan filters are not user-serviceable and must be replaced by a Cepheid Field Service Engineer. Request your Cepheid Field Service Engineer to replace the fan filters on the next service call for the system.

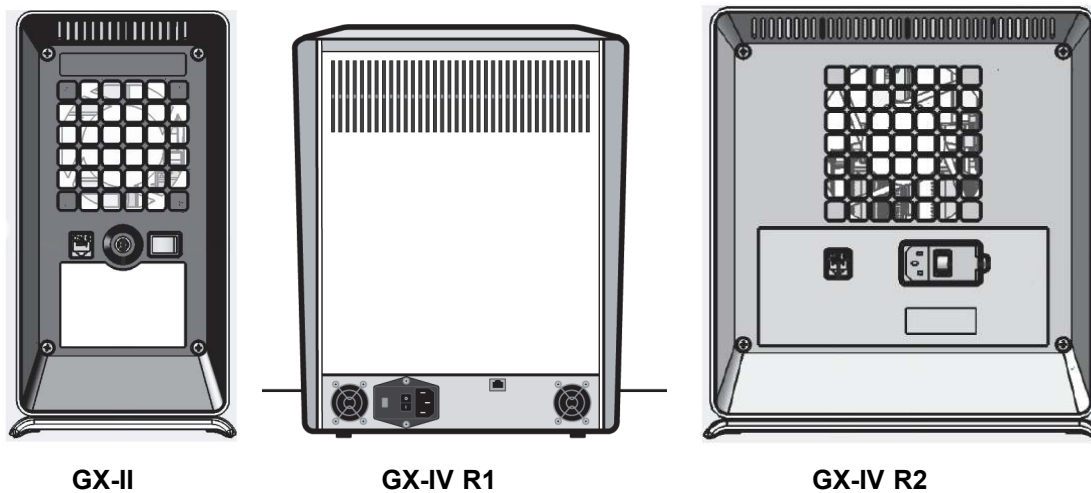

Figure 9-8. Old-Style Filters (Not User-Serviceable)

If the rear panels look like the instruments shown in [Figure 9-9](#), the fan filters can be cleaned by performing the procedure below.

9.11.2 User-Serviceable GX-II and GX-IV Fan Filters

Note

In order to minimize system downtime, Cepheid recommends that you have a spare fan filter available to swap with the dirty fan filter being cleaned. After removing the fan filter, it may be cleaned and re-used the next time that a fan filter is removed for cleaning.

Clean the fan filters weekly or more frequently, if necessary. Replace the fan filters quarterly, or more frequently if necessary. There is one fan filter on both the GeneXpert GX-II and the GeneXpert GX-IV instruments. Location of the fan filters is on the back of the instruments (see [Figure 9-9](#)). The materials needed for the procedure are as follows:

- Replacement fan filters:
 - GeneXpert GX-II—Filter Part Number: 001-1271
 - GeneXpert GX-IV—Filter Part Number: 001-1537
- Paper towels

- Water
- Disposable gloves

Important

The GeneXpert instrument and computer must be powered down prior to performing the fan filter cleaning described below. This procedure must be performed on a weekly basis.

1. Make sure all tests have finished running before attempting to move the instrument.
2. Turn off the GX-II or GX-IV instrument and the computer following the instructions in [Section 5.2, Getting Started](#).

Note

If needed, gently move the instrument when performing the following procedure for fan filter cleaning.

Warning



See the weights table in [Section 4.2, General Specifications](#) for GeneXpert instrument weights. Use care when moving the instrument. Do not attempt to lift the instrument without proper safety training and assistance. Lifting or moving the instrument without proper training and assistance can cause personal injury, damage the instrument, and void your warranty.

Caution



Be careful not to drop the instrument.

3. Reposition the instrument so the fan filter can be easily accessed. See [Figure 9-9](#).

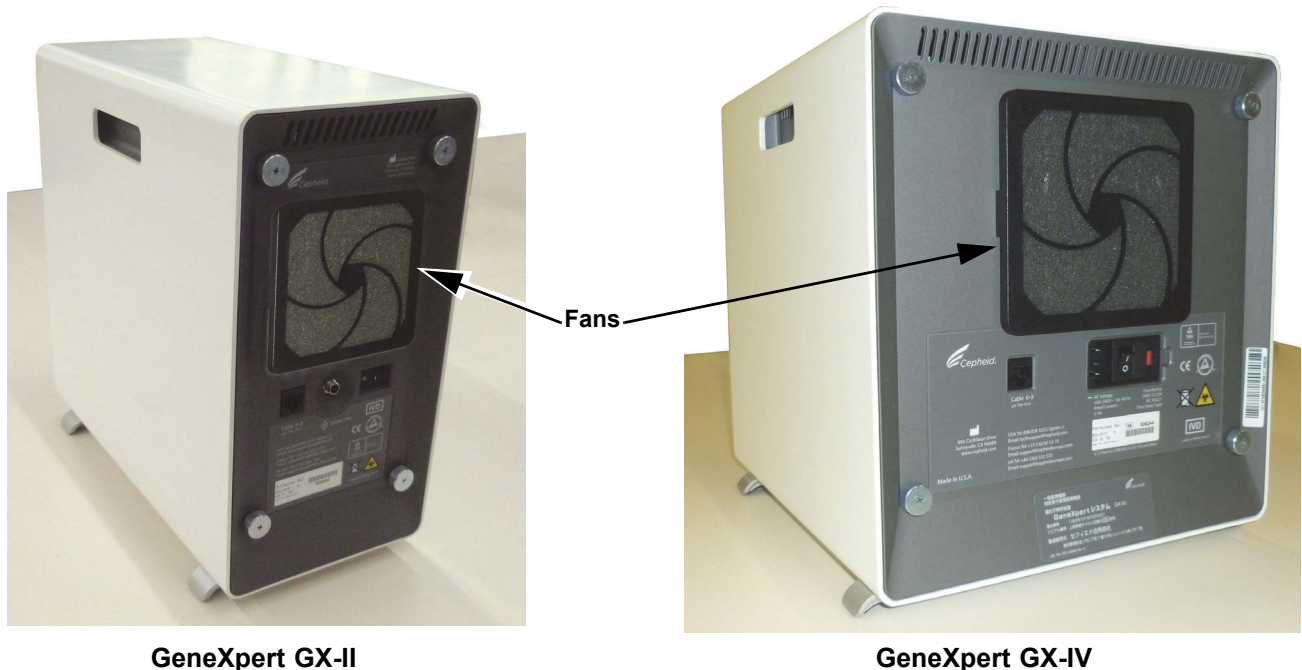

GeneXpert GX-II

GeneXpert GX-IV

Figure 9-9. GeneXpert GX-II and GeneXpert GX-IV Instruments Positioned for Access to Fans

4. Gently take the fan filter guard off by unsnapping the guard from the fan housing (see [Figure 9-10](#)) and place it aside for the remainder of the procedure for filter removal and cleaning.

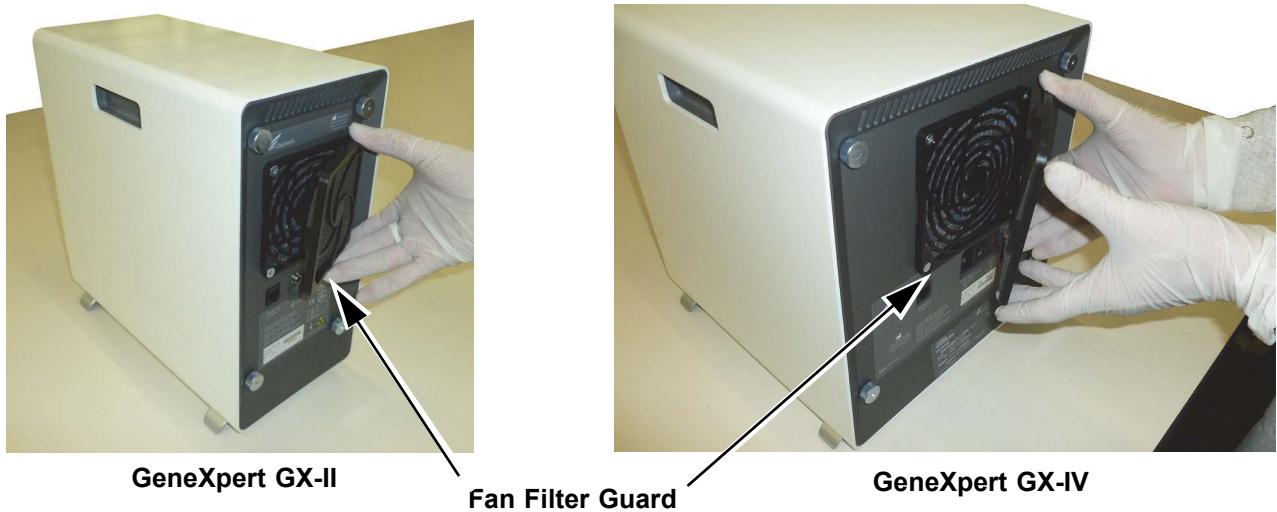

Figure 9-10. Removing Fan Filter Guard

5. Remove the dirty filter for cleaning. See [Figure 9-11](#).

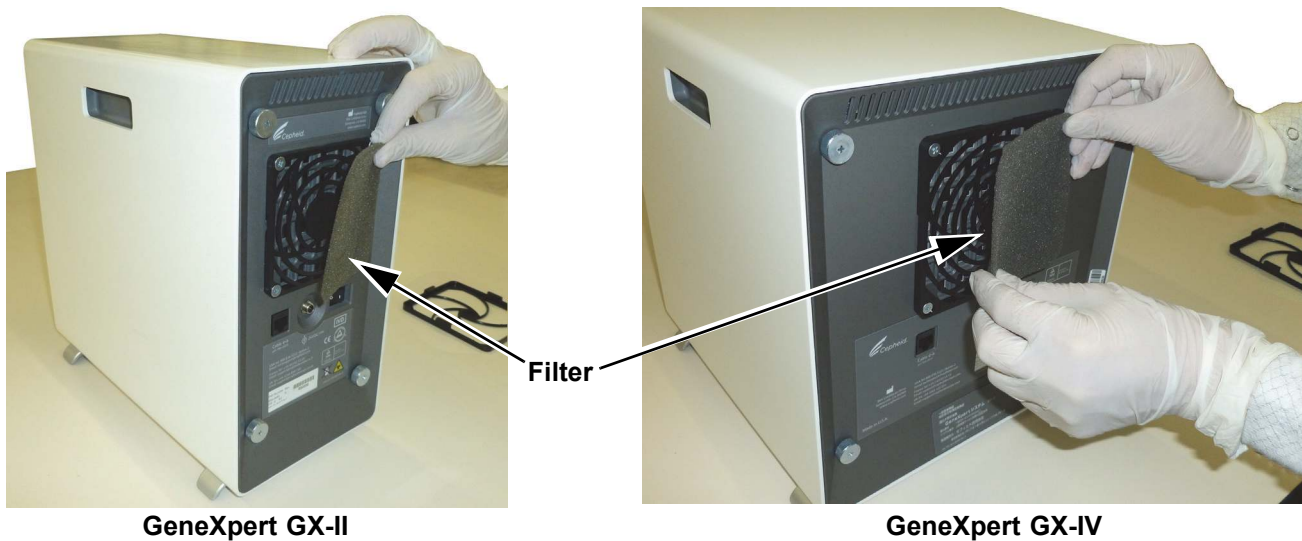

Figure 9-11. Filter Removal

6. Place a clean filter into the fan filter guard.
7. Position the fan filter guard and filter into place as a unit. Press the sides of the guard firmly onto the fan housing until the grip snaps securely onto the fan. Press the bottom of the guard until the grip snaps securely onto the fan. See [Figure 9-12](#).

**GX-II: Pressing the Bottom into Place****GX-IV: Pressing the Sides into Place****Figure 9-12. Installing the Fan Filter Guard**

8. Clean the old filter by washing it. Place this cleaned filter between two paper towels and allow it to air-dry.

Caution

Never wash a fan filter and then put it back onto the system immediately. The fan filter must be completely dry before installing it onto the system.

9. After the filter is dry, store it to use the following week, when you next remove the filter for cleaning.
10. In the maintenance log (see [Figure 9-1](#)), fill in the date of the fan filter cleaning and keep it for your records.

9.11.3 GeneXpert GX-XVI Fan Filters

9.11.3.1 Procedure to Clean and Replace GX-XVI R1 Fan Filters

Note

In order to minimize system downtime, Cepheid recommends that you have spare fan filters available to swap with the dirty fan filters being cleaned. After removing a fan filter, it may be cleaned and re-used the next time that the fan filters are removed for cleaning.

Clean the fan filters weekly or more frequently, if necessary. There are four fan filters on the GeneXpert GX-XVI R1. Location of the fan filters is on the back of the GX-XVI R1. See [Figure 9-13](#). The materials needed for the procedure are as follows:

- Replacement fan filters—Filter Part Number: 001-1271
- Paper towels
- Water
- Disposable gloves

Important

The GeneXpert instrument and computer must be powered down prior to performing the fan filter cleaning described below. This procedure must be performed on a monthly basis.

1. Make sure all tests have finished running before attempting to move the instrument.
2. Turn off the GX-XVI R1 instrument and the computer following the instructions in [Section 5.2, Getting Started](#).

Note

If needed, gently move the instrument when performing the following fan filter replacement procedure.

Warning



See the weights table in [Section 4.2, General Specifications](#) for GeneXpert instrument weights. Use care when moving the instrument. Do not attempt to lift the instrument without proper safety training and assistance. Lifting or moving the instrument without proper training and assistance can cause personal injury, damage the instrument, and void your warranty.

Caution



Be careful not to drop the instrument.

3. If there is not sufficient rear access to the instrument, slide the instrument around so you can easily access the filter covers. See [Figure 9-13](#).

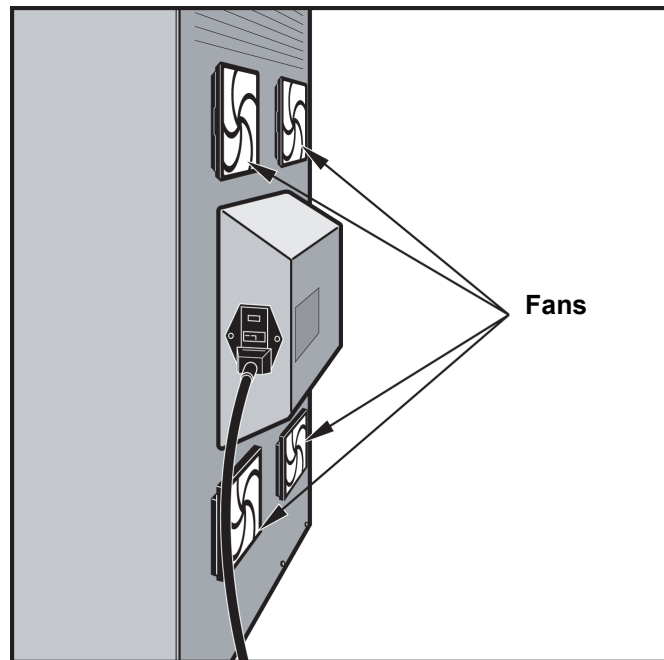

Figure 9-13. GeneXpert GX-XVI R1 Instrument Positioned for Access to Fans

4. Gently take the fan filter guard off by unsnapping the guard from the fan housing (see [Figure 9-14](#)), and place it aside for the remainder of the procedure for filter removal and cleaning.

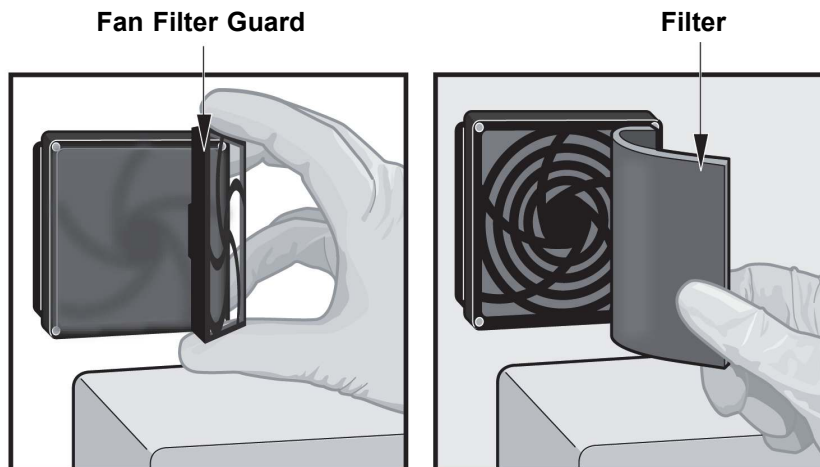

Figure 9-14. Removing Fan Filter Guard

5. Remove the dirty filter(s) for cleaning. See [Figure 9-14](#).
6. Place a clean filter into the fan filter guard.
7. Position the fan filter guard and filter into place as a unit. Press the sides of the guard firmly onto the fan housing until the grip snaps securely onto the fan. Press the bottom of the guard until the grip snaps securely onto the fan. See [Figure 9-15](#).

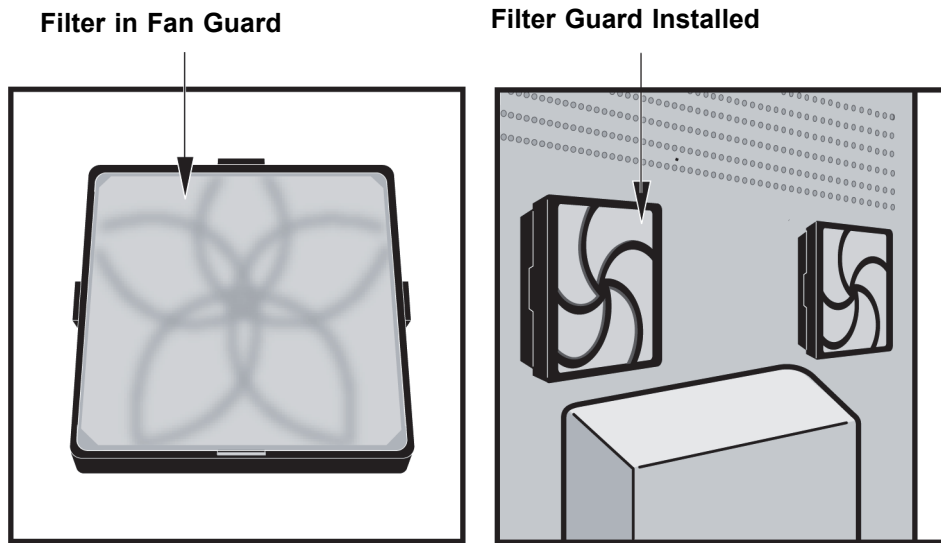

Figure 9-15. Replacement Filter and Guard Installed

8. Repeat [Step 4](#) through [Step 6](#) for the remaining fan filters (three additional filters).
9. Clean the old filters by washing them. Place each cleaned filter between two paper towels and allow it to air-dry.

Caution



Never wash a fan filter and then put it back onto the system immediately. A fan filter must be completely dry before installing it onto the system.

10. After the filters are dry, store them to use the following week, when you next remove the filters for cleaning.
11. In the maintenance log (see [Figure 9-1](#)), fill in the date of the fan filter cleaning and keep it for your records.

9.11.3.2 Procedure to Clean and Replace GX-XVI R2 Fan Filters

Note

In order to minimize system downtime, Cepheid recommends that you have spare fan filters available to swap with the dirty fan filters being cleaned. After removing a fan filter, it may be cleaned and re-used the next time that the fan filters are removed for cleaning.

Clean the fan filters weekly or more frequently, if necessary. There are four fan filters on the GeneXpert GX-XVI R2. Location of the fan filters is on the back of the GX-XVI R2. See [Figure 9-16](#). The materials needed for the procedure are as follows:

- Replacement fan filters—Filter Part Number: 001-1537
- Paper towels
- Water
- Disposable gloves

Important

The GeneXpert instrument and computer must be powered down prior to performing the filter replacement described below. This procedure must be performed on a monthly basis.

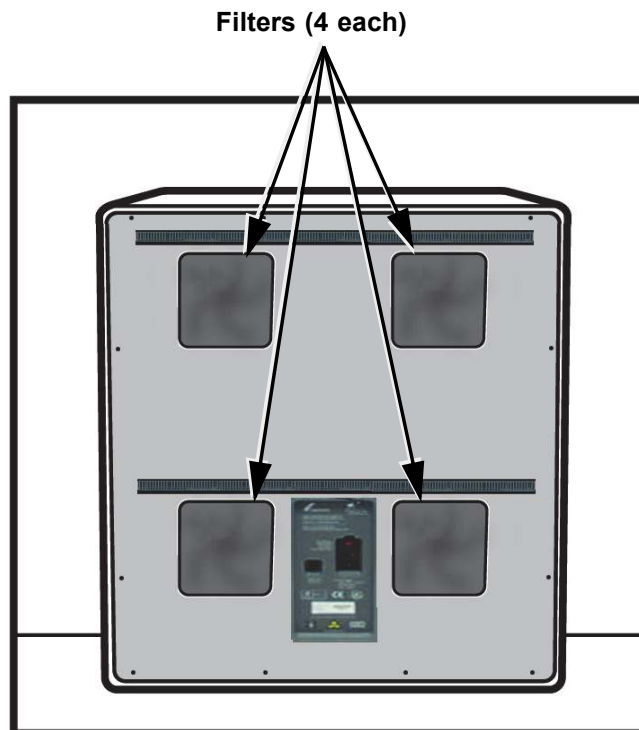

Figure 9-16. GeneXpert GX-XVI R2 Fan Filters

1. Make sure all tests have finished running before attempting to move the instrument.
2. Turn off the GX-XVI R2 instrument and computer following the instructions in [Section 5.2, Getting Started](#).

Note

If needed, gently move the instrument when performing the following fan filter cleaning procedure.

Warning



See the weights table in [Section 4.2, General Specifications](#) for GeneXpert instrument weights. Use care when moving the instrument. Do not attempt to lift the instrument without proper safety training and assistance. Lifting or moving the instrument without proper training and assistance can cause personal injury, damage the instrument, and void your warranty.

Caution



Be careful not to drop the instrument.

3. If there is not sufficient rear access to the instrument, slide the instrument around so you can easily access the filter covers.
4. Gently take the fan filter guard off by unsnapping the guard from the fan housing. See [Figure 9-17](#) and place it aside for the remainder of the procedure for filter removal and cleaning.

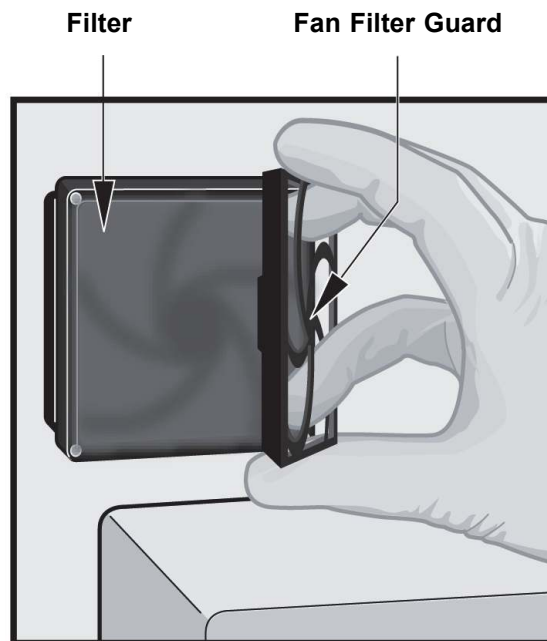

Figure 9-17. Removing the Fan Filter Guard and Filter

5. Remove the dirty filter(s) for cleaning.
6. Place a clean filter in the fan filter guard.

7. Position the fan filter guard and filter into place as a unit. Press the sides of the guard firmly onto the fan housing until the grip snaps securely onto the fan. Press the bottom of the guard until the grip snaps securely onto the fan. See [Figure 9-18](#).

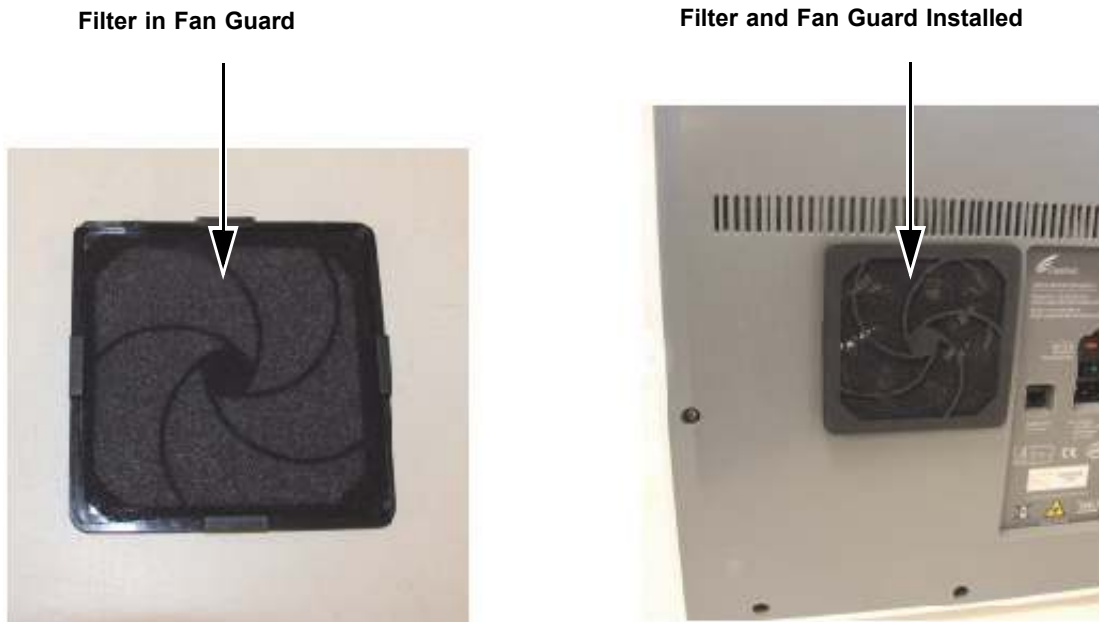

Figure 9-18. Replacing the Filter and Guard

8. Repeat [Step 4](#) through [Step 6](#) for the remaining fan filters (three additional filters).
9. Clean the old filters by washing them. Place each cleaned filter between two paper towels and allow it to air-dry.

Caution



Never wash a fan filter and then put it back onto the system immediately. A fan filter must be completely dry before installing it onto the system.

10. After the filters are dry, store them to use the following week, when you next remove the filters for cleaning.
11. In the maintenance log (see [Figure 9-1](#)), fill in the date of the fan filter cleaning and keep it for your records.

9.11.4 High Efficiency (HE) Filter Replacement Instructions

This section provides instructions for the replacement of the HE filter and prefilter, and applies only to specifically-configured GX-IV systems.

Location of the fan filters is on the back of the GX-IV (see [Figure 9-19](#)). The materials needed for the procedure are as follows:

- Replacement Filter Kit—Part Number: GX-HE-FILTERKIT
 - Contains Qty. 1 HE Filter and Qty. 6 Prefilters
- Disposable gloves

Replace the Prefilter at a minimum of once every 3 months.

Replace the HE filter at a minimum of once every 12 months.

Important

The GeneXpert instrument and computer must be powered down prior to performing the filter replacements described below.

1. Make sure all tests have finished running before attempting to move the instrument.
2. Turn off the GX-IV instrument and the computer following the instructions in [Section 5.2, Getting Started](#).

Note

If needed, gently move the instrument when performing the following filter replacement procedure.

Caution



Be careful not to drop the instrument.

3. Reposition your instrument so you can easily access the filter.



Figure 9-19. GX-IV Instrument Positioned for Access to Filter

4. Gently remove the prefilter retainer using fingers at the corners. See [Figure 9-20](#).



Figure 9-20. Removing the Prefilter Retainer

5. Remove the prefilter from the prefilter retainer. See [Figure 9-21](#). Discard the old prefilter.



Figure 9-21. Removing the Prefilter

6. Remove the HE filter retainer by releasing the clips on sides and top and bottom. The filter retainer fits very tightly and may take effort to remove. See [Figure 9-22](#).



Figure 9-22. Removing the HE Filter Retainer

7. Tilt the GX-IV instrument to the surface toward you to remove the HE filter. The HE filter should come out easily. See [Figure 9-23](#). Discard the old HE filter.

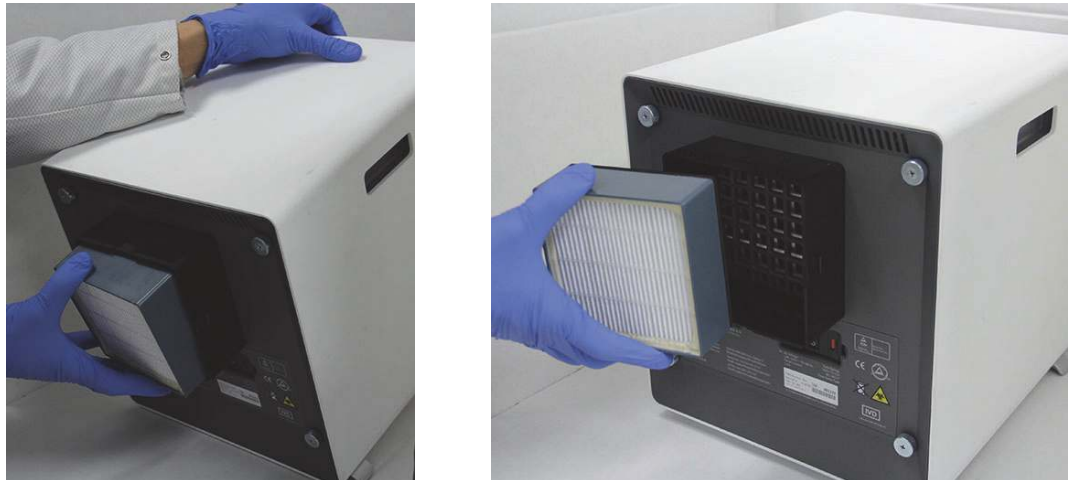

Figure 9-23. Removing the HE Filter

Installing the HE Filter, HE Filter Retainer, Prefilter and Prefilter Retainer

1. Place the new HE filter into the filter housing. The arrow on the HE filter points inward toward the instrument. See [Figure 9-24](#).



Figure 9-24. Replacing the HE Filter

2. Place the HE filter retainer on top of the HE filter. Using your fingers on the sides, top and bottom, gently push the HE filter retainer so it fits tightly. The clips on the sides, top and bottom need to engage fully. See [Figure 9-25](#)

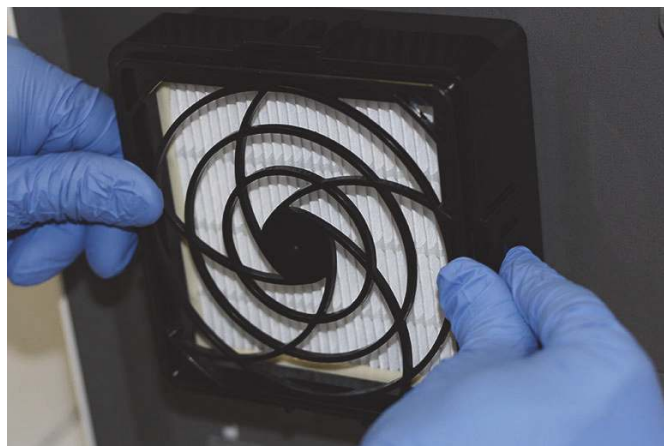

Figure 9-25. Replacing the HE Filter Retainer

3. Place the prefilter underneath the prefilter retainer so that the two are directly in contact together.
4. Place the assembled prefilter retainer and the prefilter together on top of the HE filter retainer with fingers at sides, top and bottom so it fits tightly. See [Figure 9-26](#).



Figure 9-26. Replacing the Prefilter and the Prefilter Retainer

5. The HE filter is now fully replaced and assembled on the GX-IV instrument. The filter on the instrument should resemble [Figure 9-19](#).

9.12 Annual Instrument Maintenance

Calibration of the GeneXpert instrument is not required during the initial system startup. Cepheid performs all of the necessary calibrations before the system is shipped. However, Cepheid recommends that the system be checked for proper calibration on an annual basis from the point of initial use. Based upon the usage and care of each system, calibration checks may be recommended more frequently. The system is designed to measure module performance with the internal assay controls. In the event of a module replacement, the replacement module provided will have been calibrated prior to shipment.

- Check proper calibration of the instrument
- Replace the High-Efficiency (HE) Filter, if applicable (see Section 9.11.4)

A GeneXpert operator or Field Service Engineer with Administrator user permissions can perform calibration checks during annual maintenance. Contact Cepheid Technical Support for information about calibration checks. See the [Technical Assistance](#) section in the [Preface](#) for contact information.

9.13 Using Module Reporters

Cepheid Technical Support may ask you to use the Module Reporters tool when investigating the source of possible module-related problems. The Module Reporters tool is also used to check the last date of calibration for the modules. It provides calibration information and other data, shown in [Figure 9-27](#).

To view the Module Reporters, go to the Maintenance screen. Click on **Maintenance** on the menu bar and select **Module Reporters**. The Module Reporters window appears. See [Figure 9-27](#).

Click the drop-down menu to view a different module.

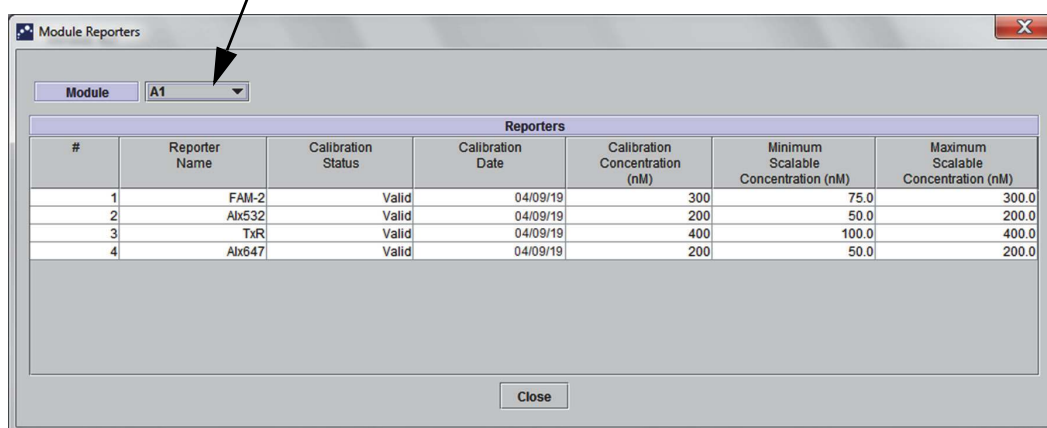

Figure 9-27. Module Reporters Window

9.14 Performing a Manual Self-Test

Note No tests can be running in the GeneXpert Dx system when performing a manual self-test.

The GeneXpert Dx system automatically performs a self-test during startup. However, a self-test can be manually initiated on any of the modules to reset and check for hardware failure problems.

To start the self-test:

1. Remove cartridges from the modules to be checked.
2. In the GeneXpert Dx System window, click the **Maintenance** icon. The Maintenance screen appears. See [Figure 9-30](#).

3. Click on **Maintenance** on the menu bar and select **Perform Self-Test**. The Module Self-Test dialog box appears. See [Figure 9-28](#).

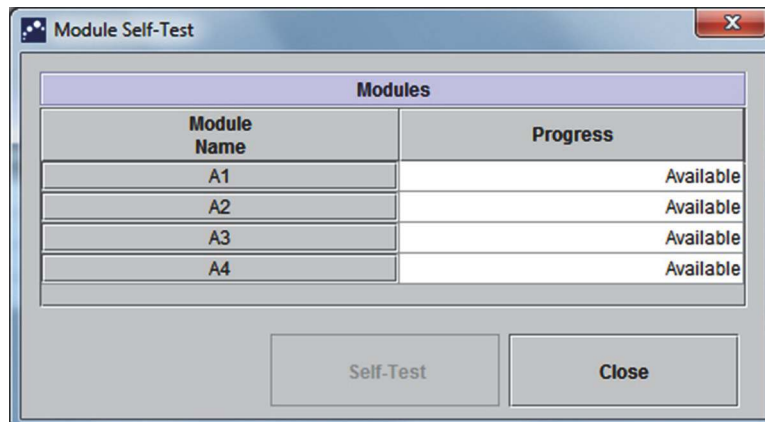

Figure 9-28. Module Self-Test Dialog Box

4. Select the module to be checked.
5. Click **Self-Test**. The Self-Test dialog box appears. See [Figure 9-29](#).

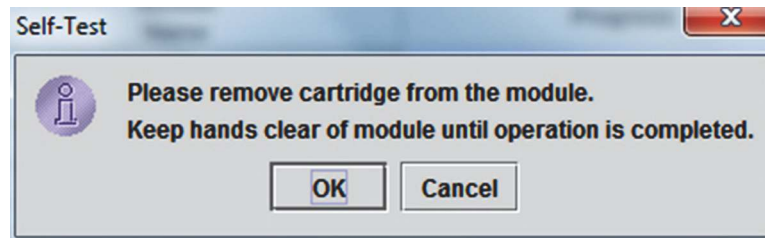

Figure 9-29. Self-Test Dialog Box

6. Follow the instructions in the Self-Test dialog box and click **OK**.
7. When the self-test finishes, the software changes the progress to **Available**, indicating the self-test passed. If the message indicates the self-test failed, contact Cepheid Technical Support. See the [Technical Assistance](#) section in the [Preface](#) for the contact information.

9.15 Excluding Modules from Test

Modules may be excluded from testing, if desired, by following the instructions in this section. Modules that are excluded will be listed as **Disabled**, and will not be used by the system to run tests.

To exclude modules from a test:

1. In the GeneXpert Dx System window, click the **Maintenance** icon. The Maintenance screen appears. See [Figure 9-30](#).
2. Click on **Maintenance** on the menu bar and select **Exclude Modules From Test**. The Exclude Modules From Test dialog box appears. See [Figure 9-31](#).

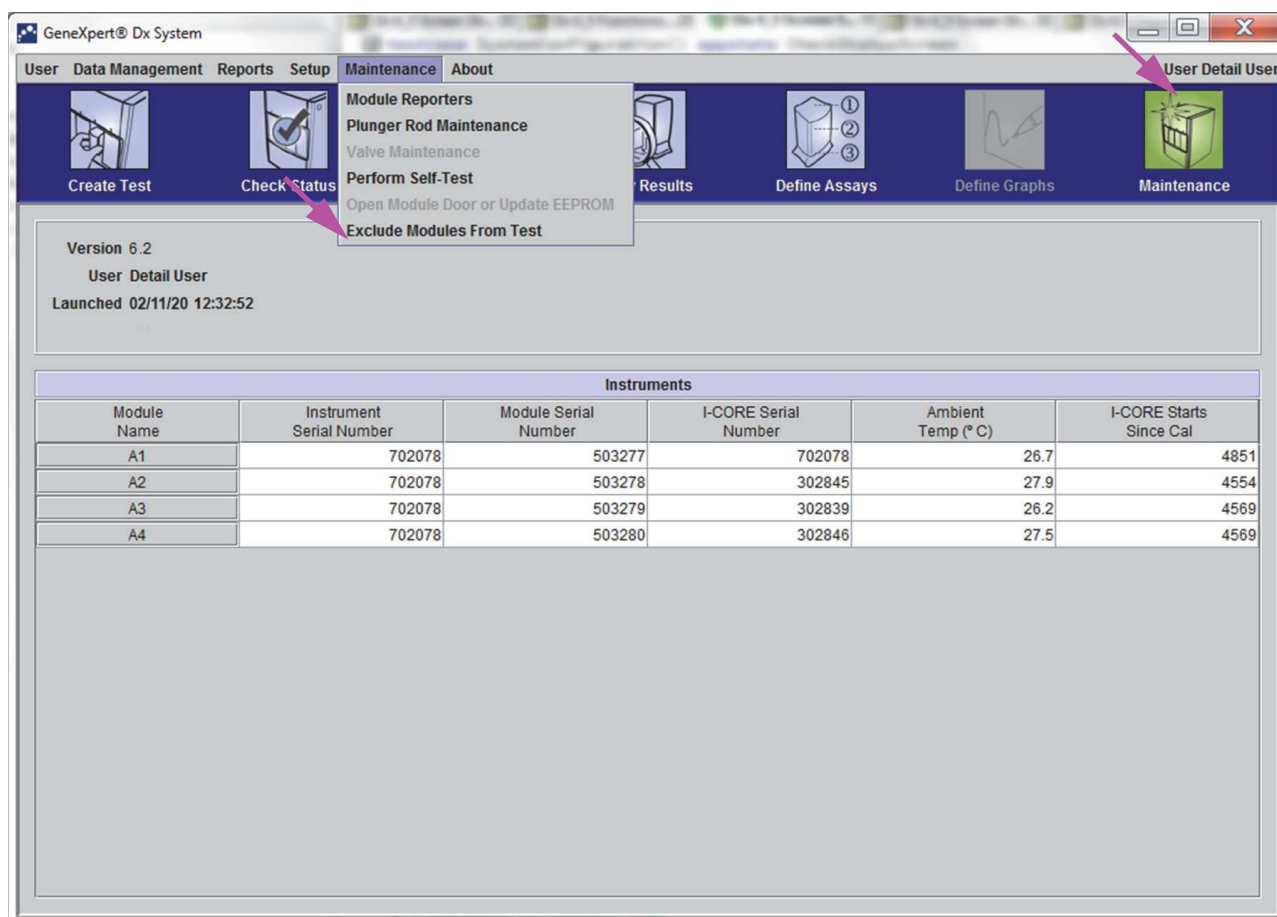

Figure 9-30. GeneXpert Dx System Window

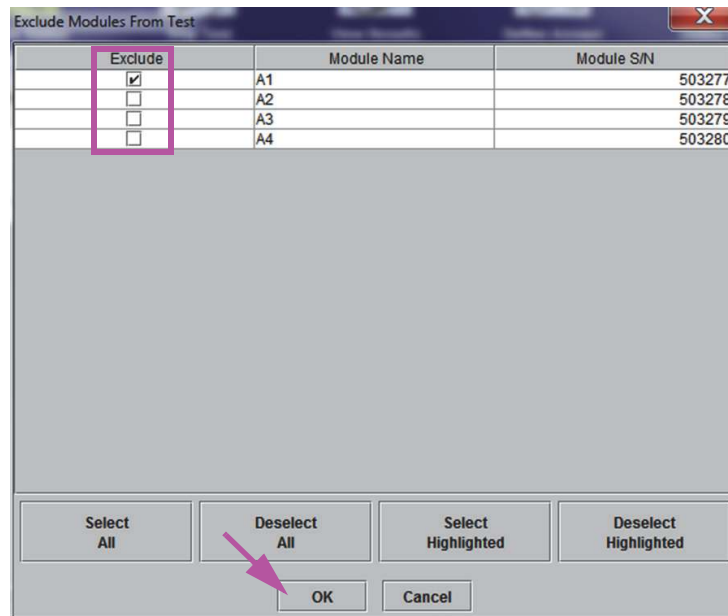

Figure 9-31. Exclude Modules From Test Dialog Box

3. Select the module(s) to be excluded from test by clicking on the adjacent check box.
4. Press the **OK** button to save changes to the Exclude Modules From Test dialog box (see [Figure 9-31](#)).
Press the **Cancel** button to cancel changes.

9.16 Generating the System Log Report

The System Log reports can be used to provide incidents of instrument module self-tests and errors to Cepheid when a module failure has been encountered.

1. In the GeneXpert Dx System window, click **Reports** on the menu bar, and then click **System Log**. The System Log Report window appears. See [Figure 9-32](#).

Select	Module Name	Module Serial Number
<input checked="" type="checkbox"/>	A1	503277
<input checked="" type="checkbox"/>	A2	503278
<input checked="" type="checkbox"/>	A3	503279
<input checked="" type="checkbox"/>	A4	503280

Figure 9-32. System Log Report Window

2. Specify the following criteria to view the trends of interest:
 - **Date Range:**
 - **All**—Select to include all of the records.
 - **Select**—Select to filter the records by specifying a range of dates. Entries older than 1 year are automatically removed.
 - **Modules:**
 - **Currently Connected Modules**— Displays modules that are connected to the system and are currently shown on Check Status screen. This is the default option.

- **All Logged Modules**—Displays all modules which have self-test or error entries in this system database within the last 1 year. This allows technical support to obtain self-test/error entries for a module that is no longer connected to the system.
A list of modules is displayed in the table. Select the module to be included in the system log by selecting the individual modules one-by-one, or by using one of the following buttons:
 - **Select All**—Selects every module shown in the table by checking all check boxes.
 - **Deselect All**—Deselect every Module by clearing all check boxes.
 - **Select Highlighted**—Selects the row(s) highlighted by the mouse.
 - **Deselect Highlighted**—Deselect the highlighted rows and clear the check boxes.
 - **Show:**
 - **Errors Only**—Displays only error entries in the generated report file.
 - **All Entries**—Displays all self-test entries and error entries in the report.
3. When you finish selecting the log criteria, click one of the following buttons:
- **Generate Report File**—Creates a PDF file and saves it to the location you specify.
 - Click the **Generate Report File** button on the System Log Report screen (see [Figure 9-32](#)) to create the PDF file of the test report. The Generate Report File dialog box will appear, which enables a file to be saved to a specified location. Click **Save** after navigating to the specific location.
 - Optionally, to print the report, go to the saved location, open the System Log report and print it. A report similar to the System Log report shown in [Figure 9-33](#) will be printed.
 - **Preview PDF**—Creates a PDF file and displays the file in the Adobe Reader window. See [Figure 9-33](#). The PDF file can be saved and printed from the Adobe Reader software.
4. After printing the System Log report, click **Close** to close the System Log Report window.

GeneXpert PC 02/09/20 12:59:42

System Log Report

- Selection Criteria -
 Date Range: All
 Modules: Currently Connected Modules
 Module A1,A2,A3,A4.
 Show: Errors Only
 User: Detail User

Module Name	Instrument S/N	Module S/N
A1	702078	503277

#	Description	Detail	Time	Version
1	Self-test error	Error 4001: A problem with the memory of the I-CORE was detected	02/09/20 12:58:20	6.2

Module Name	Instrument S/N	Module S/N
A2	702078	503278
<No Data Available>		

Module Name	Instrument S/N	Module S/N
A3	702078	503279
<No Data Available>		

Module Name	Instrument S/N	Module S/N
A4	702078	503280
<No Data Available>		

If there is an issue with an instrument, contact Technical Support.

GeneXpert® Dx System Version 6.2 Page 1 of 1

Figure 9-33. An Example of a System Log Report

9.17 Replacing Instrument Parts

Caution



Do not attempt to replace the power cord or Ethernet cable using non-approved parts. Using incompatible parts can damage the instrument, cause performance problems or cause loss of data.

You can replace the following GeneXpert instrument parts:

- Power cord for GeneXpert GX-IV and GeneXpert GX-XVI
(Part Number: 100-1375)
- Ethernet cable (Part Number: 700-0555)
- DC Adapter Power Supply for GeneXpert GX-I R2 and GeneXpert GX-II R2
(Part Number: 100-3632)
- Power Cord for GeneXpert GX-I R2 and GeneXpert GX-II R2
(Part Number: 100-3717)

You can obtain the power cord, Ethernet cable, and DC adapter power supply from Cepheid. See the [Technical Assistance](#) section in the [Preface](#) for the contact information.

9.18 Repairing the Instrument

Warning



Do not attempt to open or remove the instrument covers. Doing so can expose you to electrical hazards and cause injuries or death.

Warning



Do not attempt to open or remove the instrument covers. Do not attempt to modify or repair the system. Improper repairs and incorrect part replacements can cause injury, damage the instrument, and void your warranty.

To protect your warranty and for proper operation, the GeneXpert Dx system should be serviced only by an authorized Cepheid representative. If the instrument is not working correctly, contact Cepheid Technical Support. See the [Technical Assistance](#) section in the [Preface](#) for the contact information. When you call Cepheid Technical Support, be prepared to supply the serial number of your instrument. You can find the serial number label on the back side of the instrument.

9.19 Troubleshooting

This section lists the possible problems or error messages you might encounter. The topics are as follows:

- [Section 9.19.1, Hardware Problems](#)
- [Section 9.19.2, Error Messages](#)

9.19.1 Hardware Problems

[Table 9-2](#) lists the possible hardware problems you might encounter. To contact Cepheid Technical Support, see the [Technical Assistance](#) section in the [Preface](#) for the contact information.

Table 9-2. Hardware Problems

Problem	Possible Cause	Solution
The system does not start.	The instrument is not connected to the power outlet.	Check the instrument power connections.
Module not detected.	Network cable not connected or incorrect cable installed. Software launched before instrument turned on. The IP address is not assigned correctly.	Connect network cable (Cepheid P/N 700-0555). Exit software and relaunch with instrument powered on. Change IP Address Setting by performing the steps provided in Section 2.9.3, IP Address .
Hardware failure.	Using software version less than 4.0 with 6-color instrument.	Turn system off and update software.
Barcode scanner failure.	Symbology unsupported. Scanner barcode cable not plugged in.	GeneXpert Dx software supports Code 39, Codebar, Code 128 (A, B and C) linear barcode symbologies and Interleave 2 of 5. Unplug scanner and replug into computer.
The cartridge is stuck inside the instrument module.	Module mechanical failure.	To remove the cartridge: <ul style="list-style-type: none"> • In the GeneXpert Dx System window, click Maintenance on the toolbar. • On the Maintenance menu, click Open Module Door or Update EEPROM. • Select the module. • Click Open_Door to open the module door. <p>If the door does not open, cycle the instrument power and repeat the above steps.</p>

Table 9-2. Hardware Problems (Continued)

Problem	Possible Cause	Solution
The instrument module red light is flashing.	Module mechanical failure.	Confirm no cartridge is in the module. Perform a self-test manually (Section 9.14, Performing a Manual Self-Test). If the error recurs, contact Cepheid Technical Support.
Test report is not printed at the end of run.	Printer off line. Printer out of paper and/or toner.	Check: <ul style="list-style-type: none"> • Printer on-line. • Paper present. • Toner OK.
Unable to create a test.	Modules not available. No assay selected. Module not calibrated for reporters used in assay. The ambient temperature of the module is above 55 °C.	Check that assay is selected. Calibrate with assay dyes. Check that the modules are not disabled. Check module temperature in Maintenance screen. If your room is in the recommended temperature range and the module is above 55 °C, contact Cepheid Technical Support.
Unable to start test.	Reporters out of calibration.	Check module reporters in maintenance window: Reporter for assay are present. Calibration status is valid.

9.19.2 Error Messages

This section lists the error messages and provides possible causes and solutions. The error messages are grouped by the categories shown in the software:

- **Section 9.19.2.1, Run-Time Errors**—Errors that occur during a test. This list includes five codes that were added to support assay development. If these codes are encountered, the error status will be reported as **OK**.
- **Section 9.19.2.2, Operation Terminated Errors**—Errors that abort a test.
- **Section 9.19.2.3, Cartridge Loading Errors**—Errors that occur during a cartridge loading process.
- **Section 9.19.2.4, Self-Test Errors**—Errors that occur during the self-test process.
- **Section 9.19.2.5, Post-Run Analysis Errors**—Errors that occur during the data reduction process. You can view all of the errors in the Check Status window (see Figure 9-34). Details for test-specific errors are also shown on the **Errors** tab of the View Results window (see Figure 9-35).
- **Section 9.19.2.6, Communication Loss/Recovery Errors**—Errors that occur during the self-test process.

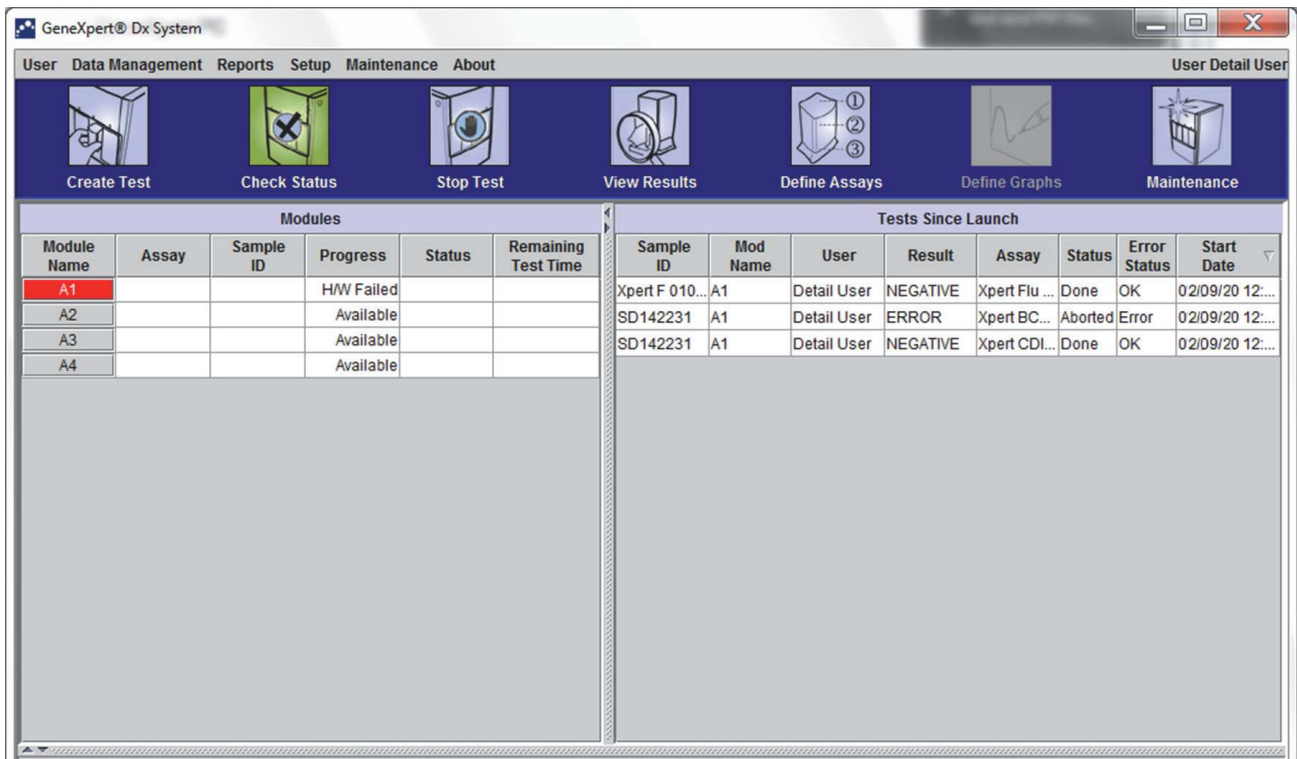

Figure 9-34. GeneXpert Dx System—Check Status Window

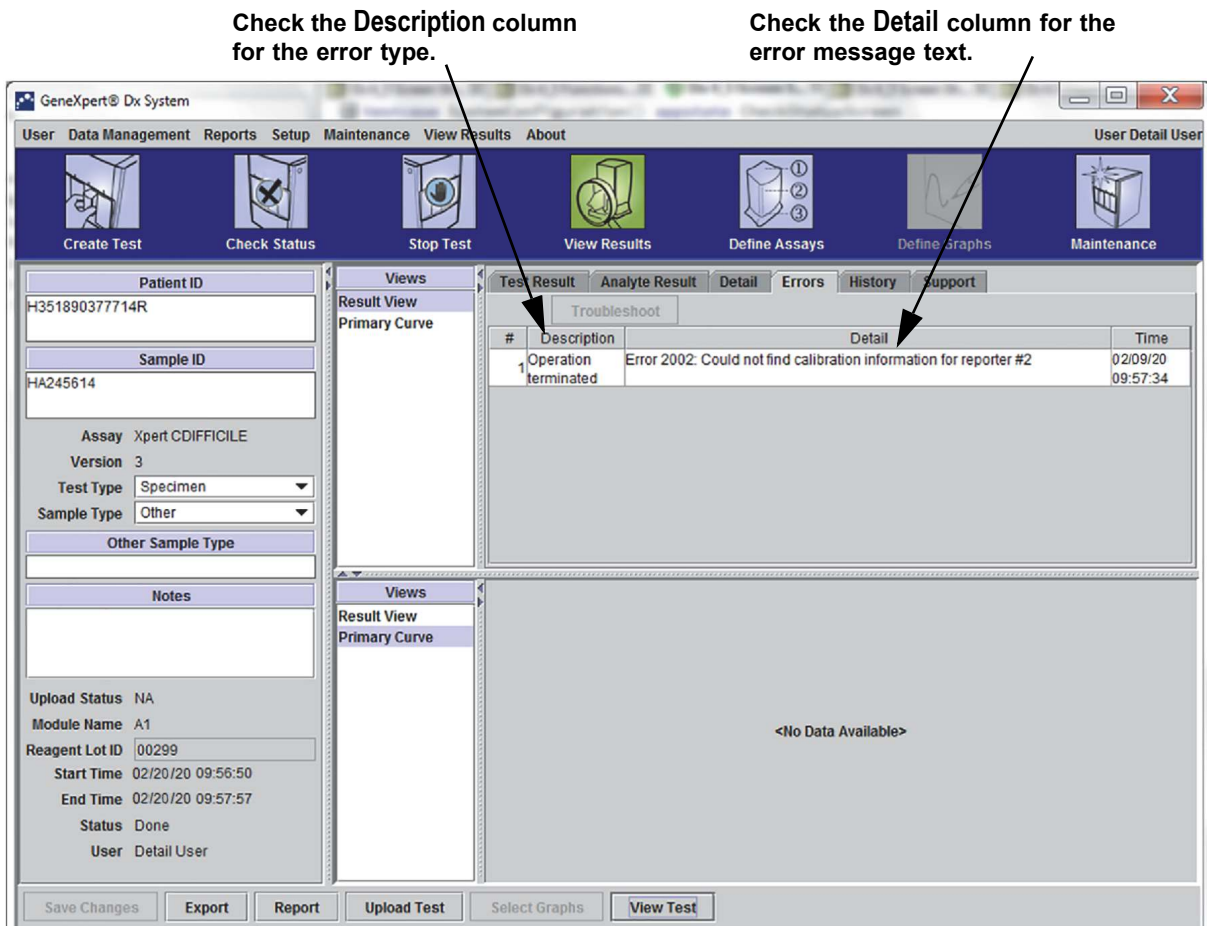

Figure 9-35. GeneXpert Dx System—View Results Window—Errors Tab (Detail Users and Administrator View)

9.19.2.1 Run-Time Errors

Table 9-3 lists errors that might appear during a test that is not aborted. Although the system was able to finish the test and save the results, some non-critical errors occurred and require attention. These error messages appear in the View Results window (see Figure 9-35). To contact Cepheid Technical Support, see the [Technical Assistance](#) section in the [Preface](#) for the contact information.

Table 9-3. Errors that Occurred During a Test that is Not Aborted

Error Code	Error Message	Possible Causes	Solution
1001	The actual temperature n °C has drifted too far away from the setpoint of m °C. (n and m are temperature values that the software displays. The values can vary.)	A heater component or a related component failed. Environment temperature is too warm. Fan Failure.	Report the temperature value in the error message to Cepheid Technical Support. Check room temperature. Check fans are functional and fan filters are clean.
1002	The temperature difference of n °C exceeds the limit of m °C. The temperatures for heaters A and B are p °C and q °C. (n , m , p , and q are temperature values that the software displays. The values can vary.)	The difference between the temperatures of the two thermistors has exceeded the acceptable difference of 5 °C.	Call Cepheid Technical Support.
1004	The internal instrument temperature n °C was out of range of $m1$ °C to $m2$ °C. (n , $m1$, and $m2$ are temperature values that the software displays. The values can vary.)	One or more of the following might have caused the error: <ul style="list-style-type: none"> The ambient temperature is not within the required range. The environmental conditions do not meet the requirements. The ambient temperature sensor failed. Broken or dirty fans 	Check the following: <ul style="list-style-type: none"> Verify the instrument has at least 5 cm (2 in) of clearance on each side. Verify the laboratory environmental conditions meet the requirements specified in Chapter 4, Performance Characteristics and Specifications. Verify fans are moving. Clean fan filters. If the instrument meets all the requirements and the error persists, call Cepheid Technical Support.
1005	Optic signal of n from detector # m using LED # p exceeded the limit of q . (n , m , p , and q are values that the software displays. The values can vary.)	One or more of the following might have caused the error: <ul style="list-style-type: none"> The signal from the reporter is too high. The module door is not closed properly. A hardware component failed. 	Try one or more of the following solutions: <ul style="list-style-type: none"> Use a different cartridge. Make sure the module door is closed completely. If the error recurs, call Cepheid Technical Support and provide the information presented in the error message.

Table 9-3. Errors that Occurred During a Test that is Not Aborted (Continued)

Error Code	Error Message	Possible Causes	Solution
1006	Detector #n dark signal of m exceeded the limit of p. (n, m, and p are values that the software displays. The values can vary.)	The detector or the electronics failed.	Call Cepheid Technical Support and provide the information presented in the error message.
1007	The n V power supply was detected to be m V. (n and m are voltage values that the software displays. The values can vary.)	The power supply voltage is out of range.	Record the information in the error message. If the error recurs in multiple runs, call Cepheid Technical Support.
1017	The measured temperature of the optical system was n °C which was not within the acceptable range of m1 °C to m2 °C. (n, m1, and m2 are temperature values that the software displays. The values can vary.)	One or more of the following might have caused the error: <ul style="list-style-type: none"> The optical block thermistor failed. The ambient temperature is too high. 	Rerun the test. If the error recurs, call Cepheid Technical Support.
1018	A valve positioning error of n count(s) was detected at the end of the run. (n is a value that the software displays. The value can vary.)	A valve component failed. Cartridge integrity compromised.	Rerun the test. If the error recurs, call Cepheid Technical Support
1096	Proceeded to Next Step #1: n, m, p, q (n, m, p, q values are assay specific)	Assay specific cause. This code is reported as maximum pressure was reached in the assay. The high pressure leads the program to move to the next step. This will not influence the performance of the assay or the assay result.	For more information on the code number (message) contact Cepheid Technical Support.
1097	Proceeded to Next Step #2: n, m, p, q (n, m, p, q values are assay specific)	Assay specific cause.	For more information on the code number (message) contact Cepheid Technical Support.
1098	Proceeded to Next Step #3: n, m, p, q (n, m, p, q values are assay specific)	Assay specific cause.	Rerun the test. If the error recurs, call Cepheid Technical Support.
1099	Proceeded to Next Step #4: n, m, p, q (n, m, p, q values are assay specific)	Assay specific cause.	Rerun the test. If the error recurs, call Cepheid Technical Support.
1100	Proceeded to Next Step #5: n, m, p, q (n, m, p, q values are assay specific)	Assay specific cause.	Rerun the test. If the error recurs, call Cepheid Technical Support.
1125	Possible Insufficient Volume Error: n, m, p, q (n, m, p, q values are assay specific)	Possible Insufficient Volume	Rerun the test. If the error recurs, call Cepheid Technical Support.

9.19.2.2 Operation Terminated Errors

Table 9-4 lists errors that might appear when a test is aborted. The operation-terminated error messages appear in the View Results window. See Figure 9-35. To contact Cepheid Technical Support, see the [Technical Assistance](#) section in the [Preface](#) for the contact information.

Table 9-4. Errors that Might Appear When a Test is Aborted

Error Code	Error Message	Possible Causes	Solution
2003	Module is already running a test with test ID n while performing command ID m. (m and n are ID numbers that the software displays. The number can vary.)	Software communication failed.	Call Cepheid Technical Support.
2005	Motion of the syringe drive was not detected. Detected motion started at position n μ l and transferred m μ l at valve position p with pressure q PSI. (n, m, p, and q are values that the software displays. The values can vary.)	One or more of the following items might have caused the error: <ul style="list-style-type: none"> A syringe stall was detected (module issue). Cartridge issue (Note if there is a time-sequence 'pattern' for the error). Cartridge lid was not opened. 	Try one or more of the following solutions: <ul style="list-style-type: none"> Use a new cartridge. Restart the system. See Section 2.17, Restarting the System for instructions. Check for crystallization in the module and if required clean module per Operation Manual instructions. Monitor for one week after cleaning. If cartridge suspected, then note the Assay Name, Cartridge Serial Number, and Cartridge Lot Number. If the error persists, call Cepheid Technical Support.
2006	Valve motion was not detected. Valve started at position n. Last detected at position m. (n and m are values that the software displays. The values can vary.)	The valve drive failed. Improper interface between cartridge and valve body.	Try one or more of the following solutions: <ul style="list-style-type: none"> Open the module and reposition the cartridge. Use a new cartridge. Restart the system. See Section 2.17, Restarting the System for instructions. If the error persists, call Cepheid Technical Support.

Table 9-4. Errors that Might Appear When a Test is Aborted (Continued)

Error Code	Error Message	Possible Causes	Solution
2008	Syringe pressure reading of f.f PSI exceeds the protocol limit of f.f PSI, command # [The command line number in the ADF] (f.f is a value that the software displays. The value can vary.)	One or more of the following items might have caused the error: <ul style="list-style-type: none"> • The filter is clogged by debris in sample. • Pressure sensor failed. 	Try one or more of the following solutions: <ul style="list-style-type: none"> • Retest sample per Package Insert using a new cartridge. • Run a new cartridge with matrix only [no patient sample added] (e.g., add to cartridge only 'Sample Reagent' or 'Samples Transport Medium' - if applicable). If the error persists, call Cepheid Technical Support. If possible, note the Assay Name, Cartridge Lot Number, Sample Type, Cartridge Serial Number and Collection information for troubleshooting.
2009	Syringe pressure reading of f.f PSI is below the protocol limit of f.f PSI, command # [The command line number in the ADF] (f.f is a value that the software displays. The value can vary.)	The filter is clogged.	Try one or more of the following solutions: <ul style="list-style-type: none"> • Use a new cartridge. • Run a cartridge containing buffer only. If the error persists, call Cepheid Technical Support.
2012	An inaccurate valve move to position n was detected. The valve was detected to stop at position m. (n and m are values that the software displays. The values can vary.)	A component of the valve drive failed.	Use a new cartridge. If the error persists, call Cepheid Technical Support.
2014	The digital temperature reading of n for Thermistor A/Thermistor B/Ambient Thermistor/Optic Thermistor was not within the acceptable range of m1 to m2. (n, m1, and m2 are temperature values that the software displays. The values can vary.)	The heater A/heater B/module's optical block thermistor failed.	Check the following: <ul style="list-style-type: none"> • The ambient temperature. • The internal temperature of the instrument. • Two inches of clearance, refer to Chapter 2 (Installation). • If the ambient and internal temperatures are within the acceptable range and you continue to see the error message, call Cepheid Technical Support.
2016	The system was unable to find the valve home position.	The valve position sensor failed.	Perform self-test and try again with another cartridge. If the error persists, call Cepheid Technical Support.

Table 9-4. Errors that Might Appear When a Test is Aborted (Continued)

Error Code	Error Message	Possible Causes	Solution
2017	The door latch sensor is still on after a cartridge eject operation.	One or more of the following might have caused the error: <ul style="list-style-type: none"> A syringe component failed. The door or a related component failed. The door sensor failed. 	To remove the cartridge: <ul style="list-style-type: none"> In the GeneXpert Dx System window, click Maintenance on the toolbar. On the Maintenance menu, click Open Module Door or Update EEPROM. Select the module. Click Open Door to open the module door. After you remove the cartridge, restart the system. See Section 2.17, Restarting the System for instructions.
2022	Failed to get to desired temperature of n °C. The temperature reached m °C. (n and m are temperature values that the software displays. The values can vary.)	Environmental temperature is above or below the acceptable range.	Check the following: <ul style="list-style-type: none"> The ambient temperature The internal temperature of the instrument Two inches of clearance, refer to Section 2.5.1 and Section 4.3, Operational Environmental Parameters. <p>If the ambient and internal temperatures are within the acceptable range and you continue to see the error message, call Cepheid Technical Support.</p>
2024	An ultrasonic horn failure occurred with n% duty cycle, m Hz and actual p% amplitude. Setpoint amplitude was q%. (n, m, p, and q are values that the software displays. The values can vary.)	The ultrasonic horn failed.	Use a new cartridge. If the problem persists, call Cepheid Technical Support.
2026	The ultrasonic horn current was detected to be out of the normal range.	The ultrasonic horn failed.	Call Cepheid Technical Support.
2032	The ultrasonic horn could not be tuned properly. The tuning frequency value was n Hz. (n is a value the software displays. The value can vary.)	The ultrasonic horn failed.	Use a new cartridge. If the problem persists, call Cepheid Technical Support.
2034	The optical signal from Detector n/LED n did not reach the expected value. Expected value=m, Actual value=p. (n, m, and p are values that the software displays. The values can vary.)	One or more of the following might have caused the error: <ul style="list-style-type: none"> The LED is not working. The detector is not working. The associated circuit is experiencing problems. 	Restart the test. If the error recurs, restart the system. See Section 2.17, Restarting the System for instructions. If the error persists, call Cepheid Technical Support.

Table 9-4. Errors that Might Appear When a Test is Aborted (Continued)

Error Code	Error Message	Possible Causes	Solution
2035	An ultrasonic failure occurred with n% duty cycle, m Hz and actual p% amplitude. Setpoint amplitude was q%. (n, m, p, and q are values that the software displays. The values can vary.)	One or more of the following might have caused the error: <ul style="list-style-type: none"> • Cartridge issue • Dirt on the horn surface • The ultrasonic horn failed. 	Restart the test. If the error recurs, restart the system. See Section 2.17, Restarting the System for instructions. If the error persists, call Cepheid Technical Support.
2096	Assay-Specific Termination Error #1: n, m, p, q (n, m, p, q values are assay specific)	Assay specific cause. Sample volume related. Refer to Package Insert for detail of error. In some cases the issue is: <ul style="list-style-type: none"> • Cartridge related • Pressure sensor failure 	Rerun the test. Ensure correct sample volume added to new cartridge. Call Cepheid Technical Support. If possible, note the following information for troubleshooting: Assay Name, Cartridge Lot, Cartridge Serial Number and Module Serial Number(s) for the error(s).
2097	Assay-Specific Termination Error #2: n, m, p, q (n, m, p, q values are assay specific)	Assay specific cause. Sample volume related. Refer to Package Insert for detail of error. In some cases the issue is: <ul style="list-style-type: none"> • Cartridge related • Pressure sensor failure 	Rerun the test. Ensure correct sample volume added to new cartridge. Call Cepheid Technical Support. If possible, note the following information for troubleshooting: Assay Name, Cartridge Lot, Cartridge Serial Number and Module Serial Number(s) for the error(s).
2098	Assay-Specific Termination Error #3: n, m, p, q (n, m, p, q values are assay specific)	Assay specific cause.	Rerun the test. If the error recurs, call Cepheid Technical Support.
2099	Assay-Specific Termination Error #4: n, m, p, q (n, m, p, q values are assay specific)	Assay specific cause.	Rerun the test. If the error recurs, call Cepheid Technical Support.
2100	Assay-Specific Termination Error #5: n, m, p, q (n, m, p, q values are assay specific)	Assay specific cause.	Rerun the test. If the error recurs, call Cepheid Technical Support.
2125	Termination Error – Insufficient Volume: n, m, p, q (n, m, p, q values are assay specific)	Specified as a “Termination Error - Insufficient Volume” in the command sequence. <ul style="list-style-type: none"> • Sample volume related • Pressure sensor failure 	Ensure correct volume added to cartridge. Retest sample per Package Insert using new cartridge. Call Cepheid Technical Support. If possible, note the following information for troubleshooting: Assay Name, Cartridge Lot, Cartridge Serial Number and Module Serial Number(s) for the error(s).
2126	Module was reset.	Intermittent power supply failure. Power supply cable or connector failure.	Restart the system. See Section 2.17, Restarting the System for instructions. If problem persists, call Cepheid Technical Support.

9.19.2.3 Cartridge Loading Errors

Table 9-5 lists errors that might appear during a cartridge loading process. The cartridge-loading error messages appear in the Check Status window. See Figure 9-34.

Because the software performs some self-test procedures during the loading process, some of the error messages that appear during loading process are identical to the self-test error messages. See Section 9.19.2.4, [Self-Test Errors](#) for the list of those messages. To contact Cepheid Technical Support, see the [Technical Assistance](#) section in the [Preface](#) for the contact information.

Table 9-5. Errors that Might Appear During the Cartridge Loading Process

Error Code	Error Message	Possible Causes	Solution
2011	Unable to initialize pressure sensor to n. Sensor value of m was obtained. (n and m are pressure values that the software displays. The values can vary.)	The force sensor failed.	Restart the test. If the error recurs, restart the system. See Section 2.17, Restarting the System for instructions. If the error persists, call Cepheid Technical Support.
2018	Attempt to load a cartridge while the door is still closed.	One of the following might have caused the error: <ul style="list-style-type: none"> The valve motor failed. A syringe component failed. The door-latch sensor failed. 	Restart the system. See Section 2.17, Restarting the System for instructions. Open door. If the error recurs, call Cepheid Technical Support.
2025	One of the following messages is displayed: The system failed to find the plunger home position. Plunger moved down looking for ADC = n. ADC value m was detected and stall occurred. The system failed to find the plunger home position. Upward move with minimum force value of n was completed without reaching force value less than m. (n and m are values that the software displays. The values can vary.)	The plunger components or the force sensor failed.	To determine if the error is caused by a failed instrument module or a bad cartridge: <ul style="list-style-type: none"> Restart the test using the same cartridge and load it into the same instrument module. If the error recurs, restart the test using the same cartridge but load it into a different instrument module. If the test progresses successfully in the new module, the previous module requires repair. Call Cepheid Technical Support. If the error occurs in the second instrument module, restart the test using a new cartridge and load it into the original module. If the test progresses successfully, the previous cartridge was bad. If the error persists, call Cepheid Technical Support.

Table 9-5. Errors that Might Appear During the Cartridge Loading Process (Continued)

Error Code	Error Message	Possible Causes	Solution
2037	The cartridge integrity test failed at valve position <n>. The pressure change of f.f PSI did not exceed the requirement of f.f PSI. The pressure increased from f.f PSI to f.f PSI during the test.	<p>One of the following may have caused the error:</p> <ul style="list-style-type: none"> The reaction tube is missing from the cartridge. The cartridge has been damaged. The cartridge integrity test failed. Pressure sensor failure. 	<ol style="list-style-type: none"> Remove the cartridge and inspect it for damage. Rerun the test using a new cartridge. <p>Call Cepheid Technical Support. If possible, note the Assay Name, Cartridge Lot Number, Cartridge Serial Number and Module Serial Number(s) for the error(s).</p>

9.19.2.4 Self-Test Errors

Table 9-6 lists errors that might appear during the self-test process. The self-test error messages appear in the Check Status window. See Figure 9-34. To contact Cepheid Technical Support, see the [Technical Assistance](#) section in the [Preface](#) for the contact information.

Table 9-6. Error Messages that Might Appear During the Self-Test Process

Error Code	Error Message	Possible Causes	Solution
4001	A problem with the memory of the I-CORE was detected.	A hardware component failed	<p>Restart the system. See Section 2.17, Restarting the System for instructions.</p> <p>Open door, select module, and update EEPROM.</p> <p>If the error recurs, call Cepheid Technical Support.</p>
4002	A problem with the main memory of the GeneXpert module was detected.	A hardware component failed.	<p>Restart the system. See Section 2.17, Restarting the System for instructions.</p> <p>If the error recurs, call Cepheid Technical Support.</p>
4003	A problem of the ultrasonic horn system was detected.	The ultrasonic drive circuitry failed.	<p>Restart the system. See Section 2.17, Restarting the System for instructions.</p> <p>If the error recurs, call Cepheid Technical Support.</p>
4004	Valve motion was not detected.	A component of the valve drive failed.	<p>Remove any cartridges from the module, and then restart the system.</p> <p>If the error recurs, perform a self-test manually (see Section 9.14, Performing a Manual Self-Test). If the error persists, call Cepheid Technical Support.</p>

Table 9-6. Error Messages that Might Appear During the Self-Test Process (Continued)

Error Code	Error Message	Possible Causes	Solution
4006	Syringe drive movement was not detected.	The stall sensor failed during cartridge loading because: <ul style="list-style-type: none"> The cartridge was not positioned correctly. A component of the syringe drive failed. 	Restart the system. See Section 2.17, Restarting the System for instructions. If the error persists, call Cepheid Technical Support.
4008	The n-V power supply was detected to be m V. (n and m are voltage values that the software displays. The values can vary.)	Power supply failure.	Restart the system. See Section 2.17, Restarting the System for instructions. If the error persists, call Cepheid Technical Support.
4009	Heater A operation was not verified. Measured temperature changed from n °C to m °C. (n and m are temperature values that the software displays. The values can vary.)	A heater A component failed.	Perform self-test. See Section 9.14, Performing a Manual Self-Test . If the error persists, call Cepheid Technical Support.
4010	Cooling fan operation was not verified. Measured temperature of n °C exceeded the limit of m °C. (n and m are temperature values that the software displays. The values can vary.)	A cooling component failed.	Make sure that the air vents are not blocked. The instrument must have at least 5 cm (2 in) of clearance on each side. Perform self-test. See Section 9.14, Performing a Manual Self-Test . If the error recurs, call Cepheid Technical Support.
4011	The reported dark value of n for detector m was too high. (n and m are values that the software displays. The values can vary.)	The module door was not closed completely, or a hardware component failed.	Make sure the module door is closed completely. If the error recurs, record the value in the error message, and then call Cepheid Technical Support.
4012	Heater B operation was not verified. Measured temperature changed from n °C to m °C. (n and m are temperature values that the software displays. The value can vary.)	A heater B component failed.	Perform self-test. See Section 9.14, Performing a Manual Self-Test . If the error persists, call Cepheid Technical Support.
4013	An inaccurate valve move was detected. The valve was programmed to stop at position n but stopped at position m. (n and m are position values that the software displays. The values can vary.)	A valve error has occurred.	If a cartridge is found in the module, remove it. Perform a self-test. See Section 9.14, Performing a Manual Self-Test . If the error recurs, call Cepheid Technical Support.

Table 9-6. Error Messages that Might Appear During the Self-Test Process (Continued)

Error Code	Error Message	Possible Causes	Solution
4014	The optical signal from Detector n/ LED n did not reach the expected value. Expected value = m, Actual value = p. (n, m, and p are optical signal values that the software displays. The values can vary.)	An optics component failed.	Call Cepheid Technical Support.
4015	The measured temperature of the optical system is n which was not within the acceptable range of m1 to m2. (n, m1, and m2 are temperature values that the software displays. The values can vary.)	An optical block thermistor failed.	Restart the system. See Section 2.17, Restarting the System for instructions. If the error recurs, call Cepheid Technical Support.
4016	GX module program corruption. Unable to continue the test	<ul style="list-style-type: none"> • Possible RAM failure • Possible EMI • Firmware defect 	Call Cepheid Technical Support.
4017	The digital temperature reading of n for Thermistor A/Thermistor B/ Ambient Thermistor/Optic Thermistor was not within the acceptable range of m1 to m2. (n, m1, and m2 are temperature values that the software displays. The values can vary.)	The heater A/heater B/module's/ optical block thermistor failed.	Restart the system. See Section 2.17, Restarting the System for instructions. If the error recurs, call Cepheid Technical Support.
4019	The optical ramp test for LED n resulted in non-monotonic results at DAC setting of nnn. The reference detector readings were nnn and nnn.	LED is broken.	Restart the system. See Section 2.17, Restarting the System for instructions. If the error recurs, call Cepheid Technical Support.

9.19.2.5 Post-Run Analysis Errors

Table 9-7 lists errors that might appear during the post-run analysis (data reduction) process. The post-run analysis error messages appear in the View Results window (see Figure 9-35). To contact Cepheid Technical Support, see the [Technical Assistance](#) section in the [Preface](#) for the contact information.

Table 9-7. Data Reduction Errors

Error Code	Error Message	Possible Causes	Solution
5001	<p>Unable to verify positive analyte [x] using curve fitting.* (x is the analyte name)</p> <p>* Note: With Error '5001' the 'Test Result' lists "Invalid" and not the word "Error".</p>	<ul style="list-style-type: none"> A component of the cartridge is defective, causing the positive growth curve to have an abnormal shape. Too much sample was placed in the cartridge. 	<p>Rerun the test using a new cartridge and the correct amount of sample.</p> <p>If the error recurs, call Cepheid Technical Support. If possible, note the following information for troubleshooting: Assay Name, Cartridge Lot Number, Cartridge Serial Number and Module Serial Number(s) for the error(s).</p>
5002	<p>Failed to verify valid amplification curve for reporter. The shape factor of n was below the minimum of m.* (n and m are values that the software displays. The values can vary.)</p> <p>* Note: With Error '5002' the 'Test Result' lists "Invalid" and not the word "Error".</p>	<p>A component of the cartridge is defective, causing the positive amplification curve to have an abnormal shape.</p>	<p>Rerun the test using a new cartridge.</p> <p>If the error recurs, call Cepheid Technical Support. If possible, note the following information for troubleshooting: Assay Name, Cartridge Lot Number, Cartridge Serial Number and Module Serial Number(s) for the error(s).</p>
5003	<p>Failed to verify valid amplification curve for reporter. The shape factor of n was higher than the maximum of m.* (n and m are values that the software displays. The values can vary.)</p> <p>* Note: With Error '5003' the 'Test Result' lists "Invalid" and not the word "Error".</p>	<p>A component of the cartridge is defective, causing the positive amplification curve to have an abnormal shape.</p>	<p>Rerun the test using a new cartridge.</p> <p>If the error recurs, call Cepheid Technical Support. If possible, note the following information for troubleshooting: Assay Name, Cartridge Lot Number, Cartridge Serial Number and Module Serial Number(s) for the error(s).</p>
5004	<p>Failed to verify valid amplification curve for reporter. The normalized sum of errors of n was greater than the limit of m.* (n and m are values that the software displays. The values can vary.)</p> <p>* Note: With Error '5004' the 'Test Result' lists "Invalid" and not the word "Error".</p>	<p>A component of the cartridge is defective, causing the positive amplification curve to have an abnormal shape.</p>	<p>Rerun the test using a new cartridge.</p> <p>If the error recurs, call Cepheid Technical Support. If possible, note the following information for troubleshooting: Assay Name, Cartridge Lot Number, Cartridge Serial Number and Module Serial Number(s) for the error(s).</p>

Table 9-7. Data Reduction Errors (Continued)

Error Code	Error Message	Possible Causes	Solution
5005	<p>Failed to verify valid amplification curve for reporter. The slope to vertical scaling ratio of n was higher than the limit of m.*</p> <p>(n and m are values that the software displays. The values can vary.)</p> <p>* Note: With Error '5005' the 'Test Result' lists "Invalid" and not the word "Error".</p>	<p>A component of the cartridge is defective, causing the positive amplification curve to have an abnormal shape.</p>	<p>Rerun the test using a new cartridge.</p> <p>If the error recurs, call Cepheid Technical Support. If possible, note the following information for troubleshooting: Assay Name, Cartridge Lot Number, Cartridge Serial Number and Module Serial Number(s) for the error(s).</p>
5006	<p>X probe check failed. Probe check value of n for reading number m was above the maximum of p.</p> <p>(x is the analyte name, n, m, and p are values that the software displays. The values can vary.)</p>	<p>One or more of the following might have caused the error:</p> <ul style="list-style-type: none"> An incorrect amount of reagent was inserted into the cartridge. The reagent is defective. Fluid transfer failed. Module related. 	<p>Check the following:</p> <ul style="list-style-type: none"> Reagents are added to the cartridge correctly. Cartridges were stored correctly. <p>Rerun the test using a new cartridge following the Package Insert.</p> <p>If the error recurs, call Cepheid Technical Support. If possible, note the following information for troubleshooting: Assay Name, Cartridge Lot Number, Cartridge Serial Number and Module Serial Number(s) for the error(s).</p>
5007	<p>X probe check failed. Probe check value of n for reading number m was below the minimum of p.</p> <p>(x is the analyte name, n, m, and p are values that the software displays. The values can vary.)</p>	<p>One or more of the following might have caused the error:</p> <ul style="list-style-type: none"> An incorrect amount of reagent was inserted into the cartridge. The reagent is defective. Fluid transfer failed. The sample was processed incorrectly in the cartridge. Module related (possible dirty optics or calibration issue). Sample specific. 	<p>Check the following:</p> <ul style="list-style-type: none"> Reagents are added to the cartridge correctly. Cartridges were stored correctly. <p>Rerun the test using a new cartridge following the Package Insert.</p> <ul style="list-style-type: none"> If the error persistently recurs: Clean module using optical brush (PN# 300-8330, Lens Cleaning Brush). Refer to Section 9.4 within "Guidelines for Cleaning and Disinfecting" or Package Insert for Xpert[®] Check (301-4121). If the error recurs, call Cepheid Technical Support. If possible, note the following information for troubleshooting: Assay Name, Cartridge Lot Number, Cartridge Serial Number and Module Serial Number(s) for the error(s).

Table 9-7. Data Reduction Errors (Continued)

Error Code	Error Message	Possible Causes	Solution
5008	X probe check failed. Probe check delta value n between reading number m and reading number p was below the minimum of q. (x is the analyte name, n, m, and p are values that the software displays. The values can vary.)	One or more of the following might have caused the error: <ul style="list-style-type: none"> An incorrect amount of reagent was inserted into the cartridge. The reagent is defective. Fluid transfer failed. 	Check the following: <ul style="list-style-type: none"> Reagents are added to the cartridge correctly. Cartridges were stored correctly. Rerun the test using fresh cartridges. If the error recurs, call Cepheid Technical Support.
5009	X probe check failed. Probe check delta value n between reading number m and reading number p was above the maximum of q. (x is the analyte name, n, m, and p are values that the software displays. The values can vary.)	One or more of the following might have caused the error: <ul style="list-style-type: none"> An incorrect amount of reagent was inserted into the cartridge. The reagent is defective. Fluid transfer failed. 	Check the following: <ul style="list-style-type: none"> Reagents are added to the cartridge correctly. Cartridges were stored correctly. Rerun the test using fresh cartridges. If the error recurs, call Cepheid Technical Support.
5010	Unable to verify positive analyte [x] using curve fitting. X readings were available, but the minimum number of readings required is y. (x is the analyte name; y is a value software displays)	A component of the cartridge is defective, causing the positive growth curve to have an abnormal shape.	Use a new cartridge. If the error recurs, call Cepheid Technical Support and provide the information in the error message.
5011	Signal loss detected in the amplification curve for analyte [x]. n decrease in signal with m% decrease at cycle p. (X is the analyte name; n, m, and p are values that the software displays. The values can vary.)	Usually occurs when a fluorescent signal is so high that it bleeds into another channel, causing the second signal to go into negative curve. In addition, the error could be due to the following: <ul style="list-style-type: none"> Sample related Module related Cartridge related 	Refer to Package Insert for specific re-test procedures. Rerun the test using a new cartridge following the Package Insert. If the error recurs, call Cepheid Technical Support. If possible, note the following information for troubleshooting: Assay Name, Cartridge Lot Number, Cartridge Serial Number and Module Serial Number(s) for the error(s).
5013	Quantitative value is too large to represent in application or database.	The base quantitative value or quantitative value is too large to display.	If the error recurs, call Cepheid Technical Support.
5014	Quantitative value is below the lower calculation limit.	The quantitative value is less than 0.01.	If the error recurs, call Cepheid Technical Support.

Table 9-7. Data Reduction Errors (Continued)

Error Code	Error Message	Possible Causes	Solution
5015	Failed to verify valid background slope for analyte [analyte name]. The absolute value of the slope of f.f was above the maximum of f.f.* * Note: With Error '5015' the 'Test Result' lists "Invalid" and not the word "Error".	High slope in optical background region.	Rerun the test using a new cartridge following the Package Insert. If the error recurs, call Cepheid Technical Support. If possible, note the following information for troubleshooting: Assay Name, Cartridge Lot Number, Cartridge Serial Number and Module Serial Number(s) for the error(s).
5016	Failed to verify valid background error for analyte [analyte name]. The RMS error of f.f was above the maximum of f.f.* * Note: With Error '5016' the 'Test Result' lists "Invalid" and not the word "Error".	High RMS error in background region.	Rerun the test using a new cartridge following the Package Insert. If the error recurs, call Cepheid Technical Support. If possible, note the following information for troubleshooting: Assay Name, Cartridge Lot Number, Cartridge Serial Number and Module Serial Number(s) for the error(s).
5017	X probe check failed. Probe check value of n for reading number m was below the valid level of p.	<ul style="list-style-type: none"> • Cartridge issue. • An incorrect amount of reagent was inserted into the cartridge. • The reagent is defective. • Fluid transfer failed • The sample was processed incorrectly in the cartridge. 	Rerun the test using a new cartridge following the Package Insert. If the error recurs, call Cepheid Technical Support. If possible, note the following information for troubleshooting: Assay Name, Cartridge Lot Number, Cartridge Serial Number and Module Serial Number(s) for the error(s).
5018	Failed to verify valid probe check ratio for analyte [analyte name]. Probe check 1 = m, probe check 2 = n, ratio = f.ff greater than maximum f.ff.	Cartridge issue.	Use a new cartridge. If the error recurs, call Cepheid Technical Support and provide the information in the error message.
5019	Failed to verify valid probe check ratio for analyte [analyte name]. Probe check 1 = m, probe check 2 = n, ratio = f.ff less than minimum f.ff.	Cartridge issue.	Use a new cartridge. If the error recurs, call Cepheid Technical Support and provide the information in the error message.

9.19.2.6 Communication Loss/Recovery Errors

Important

If module communication loss occurs after a test has been ordered and assigned to a module, but before the cartridge is loaded and the door is latched, an error message will appear that says not to proceed with loading the cartridge and latching the door. If the message instructions are followed, the cartridge may be resubmitted to another module. However, if the cartridge is loaded and the door latched, no result will be given when the test completes, and the cartridge should not be reused.

Table 9-8 lists communication errors that might appear while the module is idle, before the module door is latched or when starting the test (test is aborted). To contact Cepheid Technical Support, see the [Technical Assistance](#) section in the [Preface](#) for the contact information.

Table 9-8. Communication Loss/Recovery Errors

Error Code	Error Message	Possible Causes	Solution
2120	Module X lost communication while module was idle	Loose or faulty Ethernet cable between the PC and the GeneXpert instrument.	Verify the Ethernet cable is connected properly between the PC and the GeneXpert instrument. If the error recurs, call Cepheid Technical Support and provide the information presented in the error message.
2121	Module X lost communication before module door was latched	Loose or faulty Ethernet cable between the PC and the GeneXpert instrument.	Verify the Ethernet cable is connected properly between the PC and the GeneXpert instrument. If the error recurs, call Cepheid Technical Support and provide the information presented in the error message.
2122	Module X lost communication while starting test, test aborted	Loose or faulty Ethernet cable between the PC and the GeneXpert instrument.	Verify the Ethernet cable is connected properly between the PC and the GeneXpert instrument. If the error recurs, call Cepheid Technical Support and provide the information presented in the error message.
2124	Module X communication restored	Communication restored from loose or faulty Ethernet cable between the PC and the GeneXpert instrument.	Not applicable.

9.19.3 Troubleshooting Host Connectivity

9.19.3.1 Host Connectivity Indicator

When the software starts, host connectivity is automatically established if it is enabled. The **Check Status** button is shown as normal. See [Figure 9-36](#).

Check Status



Figure 9-36. Check Status Button Normal (Check Mark Symbol)

If host connectivity is interrupted while the system is operating, the **Check Status** button will change to an **X** sign and a message will be displayed in the Messages area of the Check Status window (see [Figure 9-37](#)). Contact your host administrator to re-establish the connection.

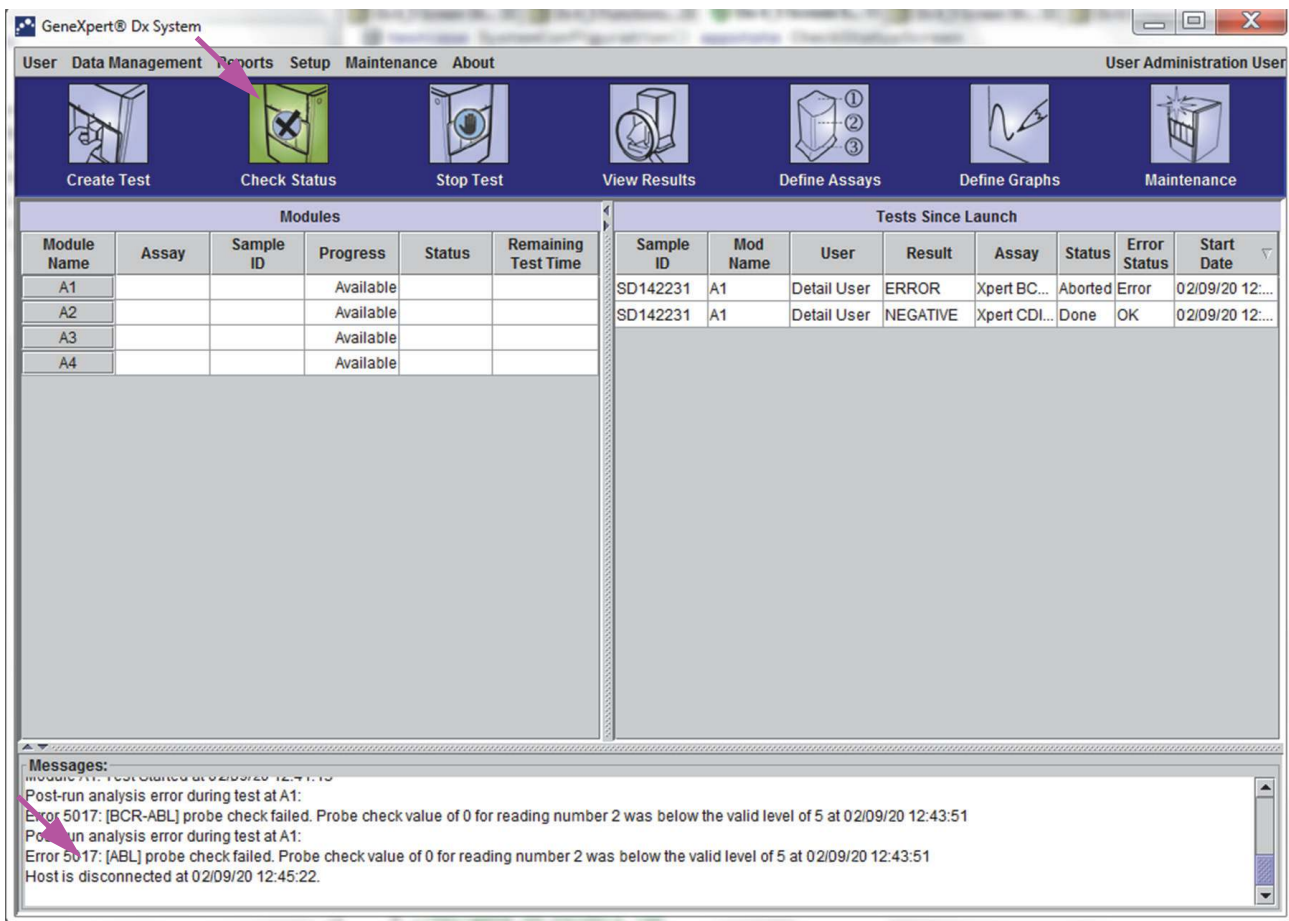

Figure 9-37. Check Status Button Symbol Changed to X and Messages Displayed

9.19.3.2 Host Communication Buffer

If the communication between the GeneXpert Dx system and the host is slow, the data may be filling up in the communication buffer. When the communication buffer is at and above 75%, the system will stop uploading results and provide a warning to the user in the Check Status screen.

When you click the **Upload Result** button in the View Results screen before the host connection is established or when the communication buffer is filled up, the Upload Result To Host dialog box appears. See [Figure 9-38](#).

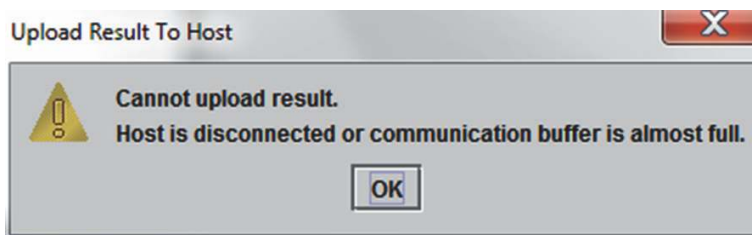

Figure 9-38. Upload Result To Host Dialog Box

9.19.4 Troubleshooting the LIS Interface

[Table 9-9](#) lists the possible system configuration problems you might encounter. To contact Cepheid Technical Support, see the [Technical Assistance](#) section in the [Preface](#) for the contact information.

Table 9-9. System Configuration Problems

Problem	Cause	Solutions
Cannot edit test code for old versions of an assay. If the LIS Administrator updates the test code, it will only apply to the new version of the assay.	Upgrade of assay to new version.	Change the test code prior to upgrade of assay.
Upload of test results with duplicate System Name; cannot tell which instrument the results came from.	Duplicate system name.	<ul style="list-style-type: none"> System name must be unique. LIS interface to check for duplicate instrument system names. LIS Administrator to control process for defining system name.
User error in selecting the assay when defining test codes.	User error in selecting the assay.	LIS Administrator to configure correct test code; for example, CPT code for test or abbreviate assay name.

A Quick Reference

This appendix provides a quick reference of the software menus and commands. In the GeneXpert Dx System window, the menus are as follows:

- [Table A-1, User](#)
- [Table A-2, Data Management](#)
- [Table A-3, Reports](#)
- [Table A-4, Setup](#)
- [Table A-5, About](#)
- [Table A-6, Create Test](#)
- [Table A-7, Stop Test](#)
- [Table A-8, View Results](#)
- [Table A-9, Define Assays](#)
- [Table A-10, Maintenance](#)

Table A-1. User

Command	Description
Login	Logs you on to your GeneXpert Dx system account.
Change Password	Changes your password.
Logout	Logs you out of your GeneXpert Dx system account.
Exit	Exits the GeneXpert Dx system software.

Table A-2. Data Management

Command	Description
Archive Test	Archives the tests you select.
Retrieve Test	Retrieves the tests you select.

Table A-3. Reports

Command	Description
Specimen Report	Displays an overview of the test results for the selected specimen in the database.
Patient Report	Displays test results for samples for one patient according to the patient ID in the database.
Control Trend Report	Displays and prints the external-control trend reports.
System Log	Displays and prints the log of module self-test and module errors.
Assay Statistics Report	Displays a report showing the number of tests performed for each assay over a period of time with monthly breakdown values.
Installation Qualification	Displays and prints the installation qualification report.

Table A-4. Setup

Command	Description
User Administration	Adds users, removes users, or edits user information.
User Type Configuration	Specifies the user type permissions.
System Configuration	Specifies the system name, date format, time format, and destination folders for exported files, reports, database logs. You can also specify other system settings.
Assign Instrument Letter	Assigns an ID to each instrument and instrument module.

Table A-5. About

Command	Description
About GeneXpert Dx System	Displays the software copyright and version number.

Table A-6. Create Test

Command	Description
Scan Patient ID	Use the barcode scanner to enter the Patient ID.
Scan Sample ID	Use the barcode scanner to enter the Sample ID.
Patient ID 2	Must be entered manually
Patient Family or Last Name	Must be entered manually.
Patient First Name	Must be entered manually
Manual entry	Use to manually enter the Patient ID, Sample ID, or cartridge information.
Scan Cartridge Barcode	Use the scanner or choose Manual Entry to enter the cartridge barcode.
Start Test	Begin the test.
Cancel	Closes the dialog box, discarding the new test.

Table A-7. Stop Test

Command	Description
Select Running	Selects all tests in progress.
Deselect All	Clears all selections.
Stop	Stops selected tests.
Cancel	Closes the dialog box.

Table A-8. View Results

Command	Description
Save Changes	Saves changes you make in the Patient ID, Patient ID 2, Sample ID, Test Type, Sample Type, Other Sample Type, and Notes boxes.
Export	Exports the selected results to a .csv file.
Report	Saves the results in a PDF file.
Upload Test	Upload selected results to LIS.
View Test	Displays list of tests that can be viewed.

Table A-9. Define Assays

Command	Description
Delete	Deletes the assay definition file (.gxa/.nxa) you select.
Move to Top	Moves the currently selected assay to top of the assay list.
Lot	Manages lot specific parameters for the selected assay definition.
Import	Imports an assay definition into the database.

Table A-10. Maintenance

Command	Description
Module Reporters	Displays optical calibration information about the instrument module.
Plunger Rod Maintenance	Lowers the syringe plunger rod for cleaning.
Valve Maintenance	This function is disabled for all users.
Perform Self-Test	Performs the self-test to check the system functions.
Open Module Door or Update EEPROM	Opens the module door to eject a stuck cartridge and update cross-platform I-CORE EEPROM format.
Exclude Modules from Test command	Lists module(s) as Disabled, and they will not be used by the system to run tests.

B Glossary

.gxa/.nxa file – an assay definition file.

.gxr/.nxr file – a lot specific parameter file.

.gxx/.nxx file – an archive file that contains multiple tests.

amplification curve – a graph that plots the number of PCR cycles against fluorescence detected. A real-time amplification curve has three distinct phases: baseline, log-linear, and plateau. The increase in fluorescence is proportional to the amount of amplicon generated and can be used to define the cycle threshold.

assay definition – a series of programmed steps to perform sample preparation, amplification, and detection procedures.

curve fit – the determination of a curve that fits a specified set of data points on a graph.

cycle threshold (Ct) – the first cycle in which the fluorescence reaches a specified threshold. The Ct can be determined by analyzing the growth curve (Primary Curve) or the second derivative of the growth curve (2nd Deriv).

data reduction – the process in which the system analyzes the raw data based on the settings in the assay definition to determine the test result.

DMS (Data Management System) – could be a stand-alone small scale information system or compliment an LIS in the same facility. A DMS is a software application which handles receiving, processing and storing information.

endogenous control – a control (gene) from the test sample that is used to normalize targets and/or help ensure that sufficient sample is used in the test.

endpoint – the fluorescence reading for the last cycle of a thermal cycling protocol.

instrument module – an individual hardware component within which fluidic and thermocycling protocols occur. Each module consists of a bay for holding a cartridge, a syringe drive, a valve drive, an ultrasonic horn, and an I-CORE module.

internal control (IC) – a control that helps verify the performance of the PCR reagents and the absence of significant inhibition that would prevent PCR amplification.

LIS (Laboratory Information System) – is a software application which handles receiving, processing, and storing information generated by medical laboratory processes. These systems often must interface with instruments and other information systems, such as hospital information systems (HIS). An LIS is a highly configurable application which is customized to facilitate a wide variety of laboratory workflow models.

lot specific parameters (LSP) – information about a reagent lot that is required by some assay definitions to determine the test results. The lot specific parameters are included in the GeneXpert cartridge 2D barcodes and in the lot specific parameter (.gxr/.nxr) files.

manual entry – entry of data into a field using the keyboard. Some fields provide a choice between scanning the data or manually entering the data, such as Patient ID or Sample ID.

module – see instrument module.

primary curve – a plot of fluorescence vs. cycle number. A real-time growth curve should have three distinct phases: baseline, log-linear and plateau. The increase in fluorescence is proportional to the amount of amplicon generated and can be used to define the cycle threshold.

probe check – a stage during the test that checks for the presence and the integrity of the labeled probes.

protocol – an assay command that defines the thermal cycling and optical data collection parameters for an assay.

reporter – a fluorescent dye used to detect specific amplification products.

sample processing control (SPC) – a control that helps ensure that a sample was correctly processed. The sample-processing control is processed with the sample and detected by PCR.

site – see instrument module.

system log – a report of incidents of instrument module self-tests and errors.

test – the laboratory process used to determine the presence of a substance and measure the amount of that substance. In the GeneXpert Dx system software, a test is a record of how a specimen is processed. The record includes the instrument module ID, the assay information, sample ID, test type, and notes about the test.

test type – the sample that is designated as a specimen, positive control, or negative control in the test.

C GeneXpert Dx Software International Configuration Instructions

C.1 Introduction

This appendix provides instructions to configure the GeneXpert Dx software to display in a non-English language. Instructions are also provided for configuring a non-English keyboard and barcode scanner.

Important

Use this document for new installations of the GeneXpert Dx software. For existing software installations, the GeneXpert Dx system should be already configured for the correct language settings. Installing an update of the GeneXpert Dx software will not change these settings. If you need assistance, contact Cepheid Technical Support. See the [Technical Assistance](#) section in the [Preface](#) for contact information.

The information in this document applies only to configuring the GeneXpert Dx system for a non-English language.

Note

GeneXpert Dx software version 6.2 supports both Windows 7 and Windows 10 operating systems. Should you need any assistance, please contact your regional Cepheid Technical Support center.

C.2 Summary

Internationalization support was added in GeneXpert Dx software releases beginning with version 4.4 and above. Systems that are updating to GeneXpert Dx version 6.2 from earlier releases require additional steps that are not necessary on systems that are installed with GeneXpert Dx version 4.4 and above:

- Configure the Windows language setting
- Configure the keyboard
- Configure the Barcode Scanner

C.3 Before You Begin

Ensure that you quit or close all applications.

C.4 Windows Configuration

This section provides information on configuring the language setting, keyboard and the welcome screen keyboard layout for Windows.

Note

For each Windows user account on the system, perform the procedures in [Section C.4.1](#), [Section C.4.2](#) and [Section C.4.3](#).

C.4.1 Language Setting

The Format and Keyboard settings must match each other in order to run the GeneXpert Dx software. The valid language and keyboard combinations for Windows are:

Format	Keyboard
English (United States)	English (United States) – US
Chinese (Simplified, PRC)	Chinese (Simplified) – Microsoft Pinyin New Experience Input Style
French (France)	French (France) – French
German (Germany)	German (Germany) – German
Italian (Italy)	Italian (Italy) – Italian
Japanese (Japan)	Japanese (Japan) – Microsoft IME
Portuguese (Portugal)	Portuguese (Portugal) – Portuguese
Russian (Russia)	Russian (Russia) – Russian
Spanish (Spain)	Spanish (Spain, International Sort) – Spanish

- For Windows 7, see [Section C.4.1.1, Configuring the Windows 7 Language Setting](#).
- For Windows 10, see [Section C.4.1.2, Configuring the Windows 10 Language Setting](#).

C.4.1.1 Configuring the Windows 7 Language Setting

1. Log in to Windows 7 using the **Cepheid-Admin** user account if not already logged in. See [Section 5.2, Getting Started](#).
2. If the GeneXpert Dx software starts, exit the software.
3. Open the Control Panel. Ensure that View by: is set to **Category** and then click **Clock, Language, and Region** (see [Figure C-1](#)).



Figure C-1. Control Panel Window

4. The Clock, Language, and Region window appears (see [Figure C-2](#)). Click **Region and Language**.

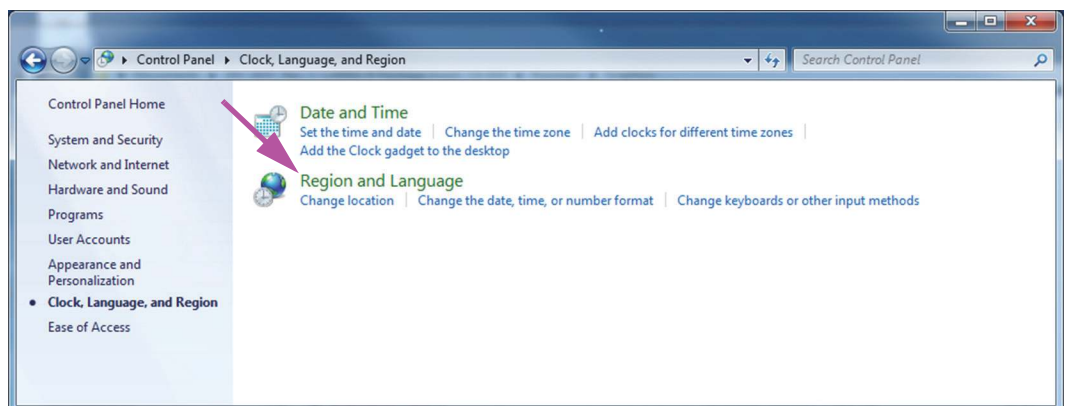

Figure C-2. Clock, Language, and Region Window

5. The Region and Language window appears. See [Figure C-3](#).

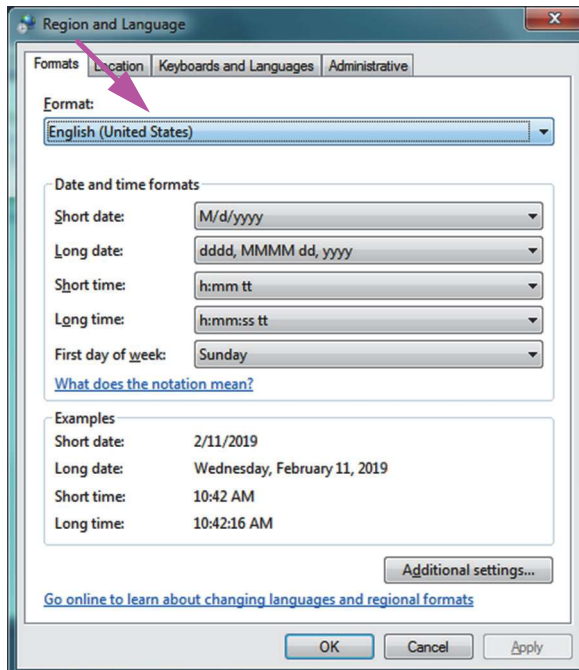

Figure C-3. Region and Language Window—Formats Tab

6. The **Format** drop-down box has **English (United States)** selected. Click the drop-down (see Figure C-3 and Figure C-4) listing the language selections available. Scroll the list to locate the desired language and select that entry.

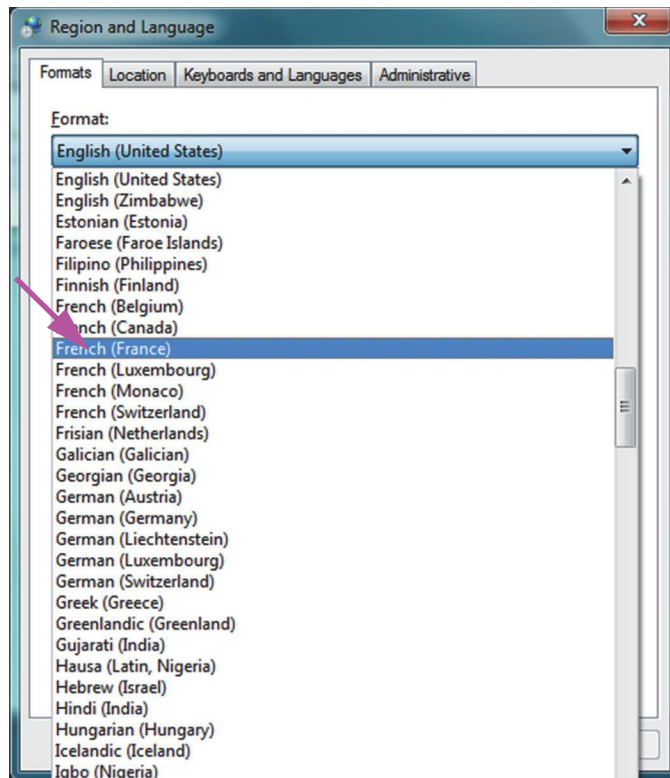

Figure C-4. Region and Language Screen - Dropdown Menu

- After selecting the new language, the drop-down list closes and the newly-selected language then appears in the Format drop-down box. In the example shown, **French** is selected. The Region and Language screen now displays French (France) in the Format drop-down box (see [Figure C-5](#)).

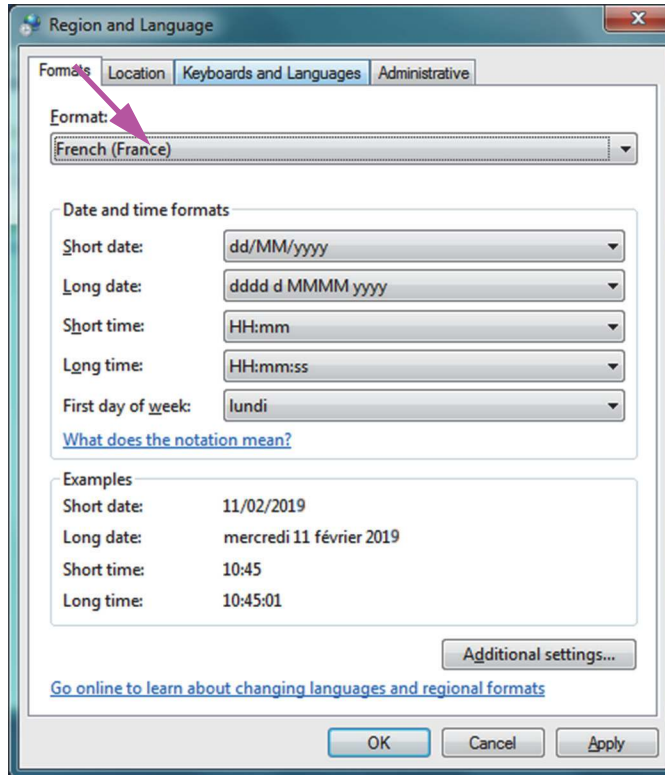

Figure C-5. Region and Language Screen—New Language Displayed

C.4.1.2 Configuring the Windows 10 Language Setting

- Log in to Windows 10 using the **Cepheid-Admin** user account if not already logged in. See [Section 5.2, Getting Started](#).
- If the GeneXpert Dx software starts, exit the software.
- Click on the **Windows Start** icon and select **Settings** from the menu. The Windows Settings window is displayed. See [Figure C-6](#).
- On the Windows Settings window, click on **Time and Language** (see [Figure C-6](#)).
- Click on **Region & Language** or **Language** on the left pane.



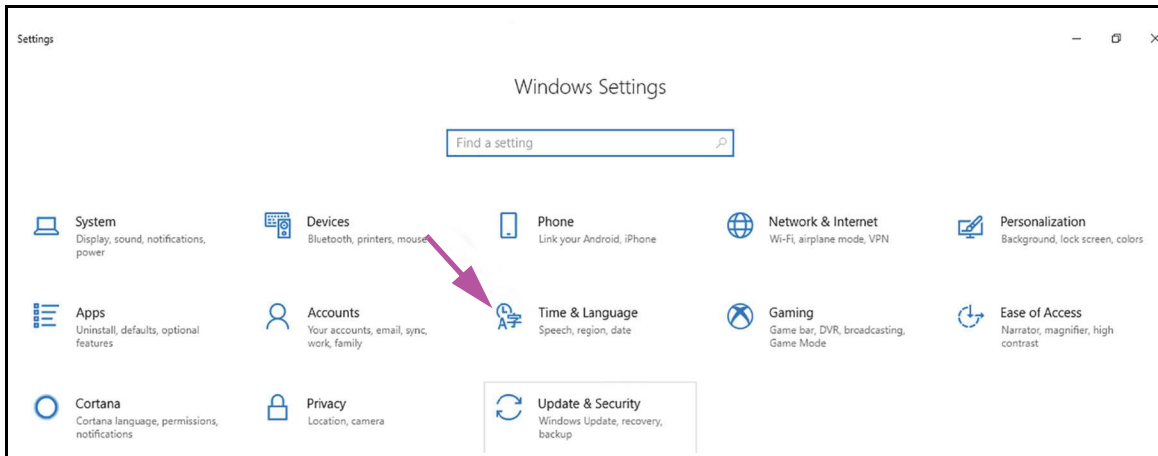

Figure C-6. Windows 10 Settings Window

6. In the Languages section of the Window, select the desired language from the drop-down menu.
7. Restart the computer to allow the changes to be applied.

C.4.2 Keyboard

If a non-English USB keyboard was provided with your Windows 7 computer, remove the existing English USB keyboard and attach a new non-English USB keyboard to the computer and configure your computer as described below.

If a non-English USB keyboard was provided with your Windows 10 computer, remove the existing English USB keyboard and attach a new non-English USB keyboard to the computer. No configuration is required.

Configuring the Windows 7 Keyboard

1. On the Region and Languages screen, click the **Keyboards and Languages** tab (see [Figure C-7](#)).

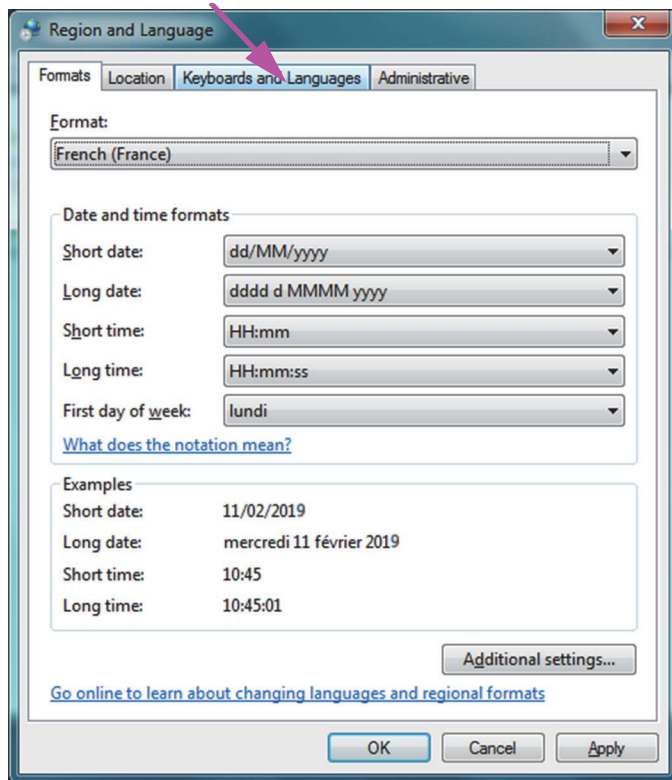

Figure C-7. Region and Language Drop-Down Window

- When the Keyboards and Languages tab appears, click the **Change Keyboards...** button (see Figure C-8). An overlay window appears, listing Installed Services (the available language keyboards).

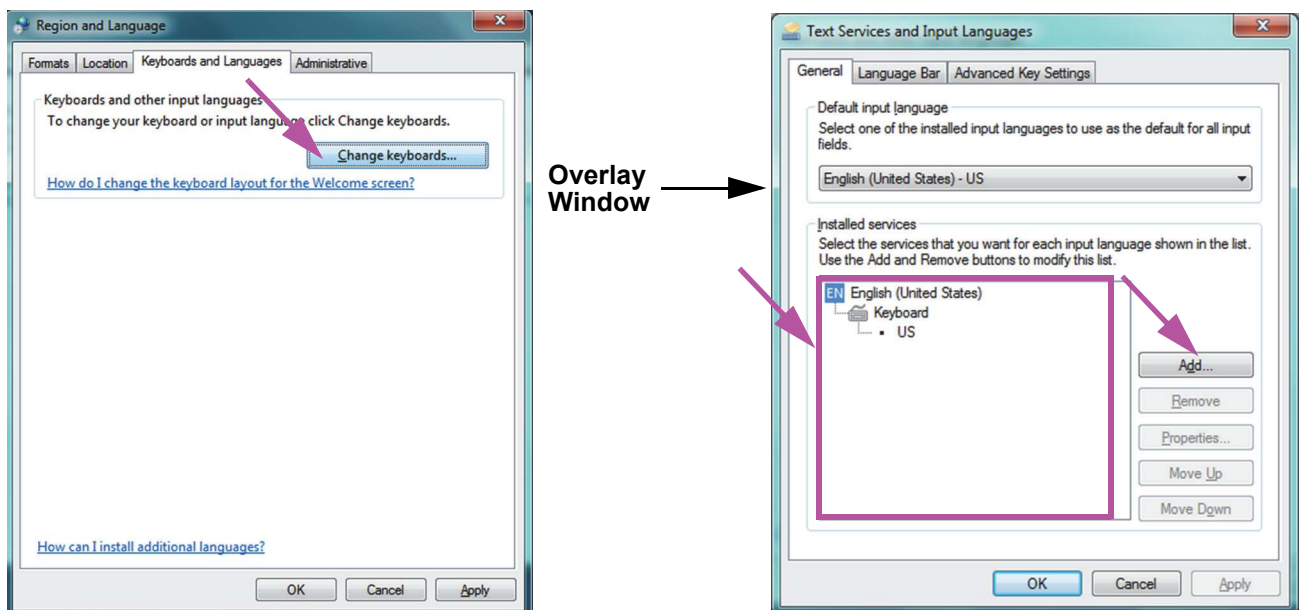

Figure C-8. Region and Language and Text Services and Input Languages Screens

- If the desired language exists in the Installed Services box, go to [Step 8](#).
If the desired language does not exist in the Installed Services box, click the **Add** button (see [Figure C-8](#)).
- On the Add Input Language window, use the drop-down menu to select the desired Language (Country) combination, click the **+** next to the Language (Country), and then click the **+** next to the Keyboard (see [Figure C-9](#)).

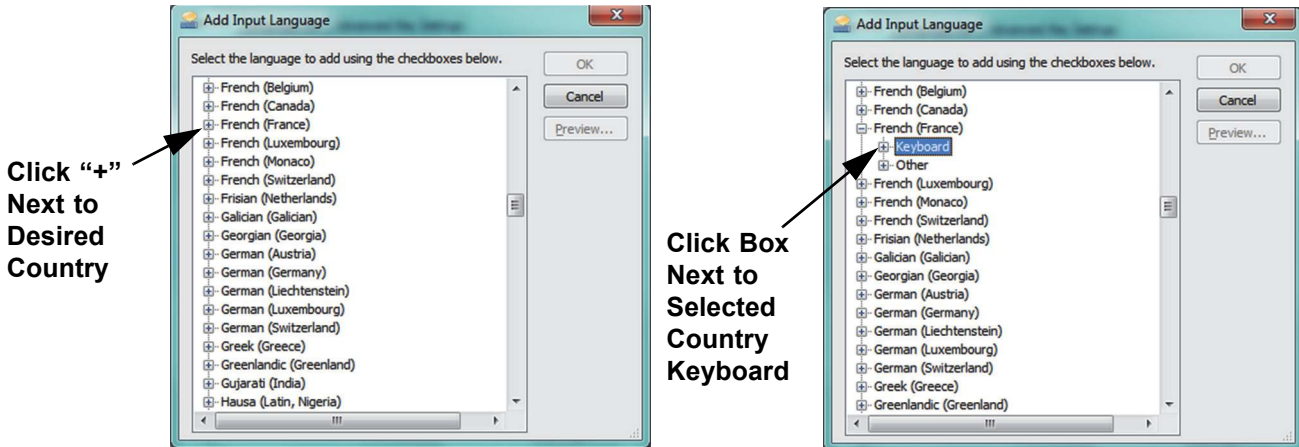

Figure C-9. Add Input Language Screen with French Selected (Example)

- After selecting the new keyboard which corresponds to the language selected in [Figure C-9](#), a drop-down menu will appear beneath the keyboard selected (see [Figure C-10](#)).

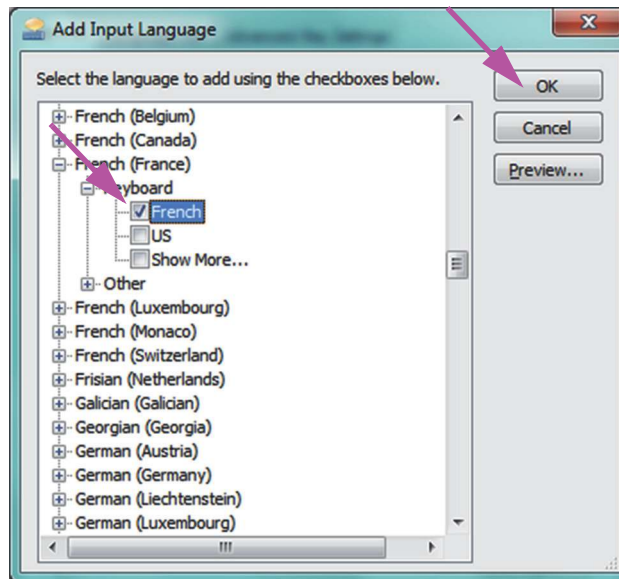

Figure C-10. The Add Input Languages Window with all Entries

- Select from the choices presented by clicking the empty box to the left of the desired entry and a check mark appears for that entry. Click the **OK** button to add the selected language. This Add Input Languages window closes, returning you to the Text Services and Input Languages screen.

- Click the **General** tab (see [Figure C-11](#)) and use the scrollable box in the Installed services section to select the (new) desired keyboard and click the **OK** button.

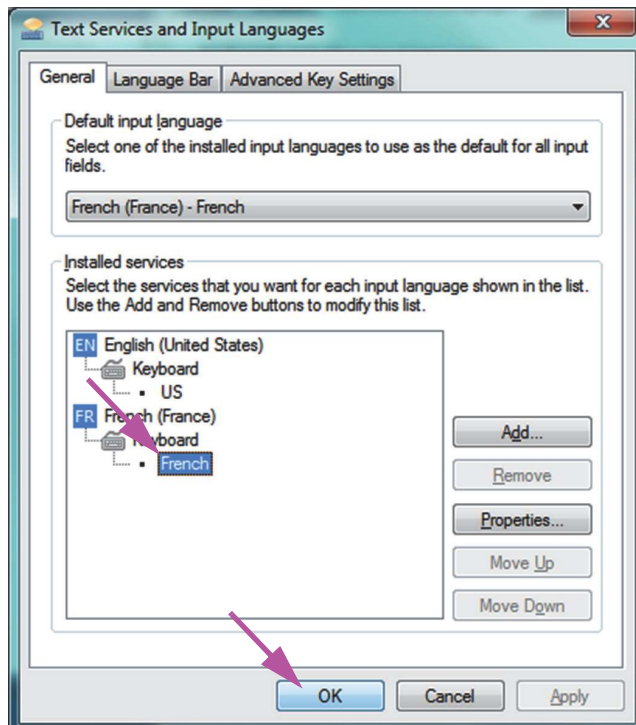

Figure C-11. Text Services and Region and Language Screen—General Tab

- Return to the Keyboards and Languages tab (see [Figure C-12](#)) and click the **OK** button to complete the keyboard language change.

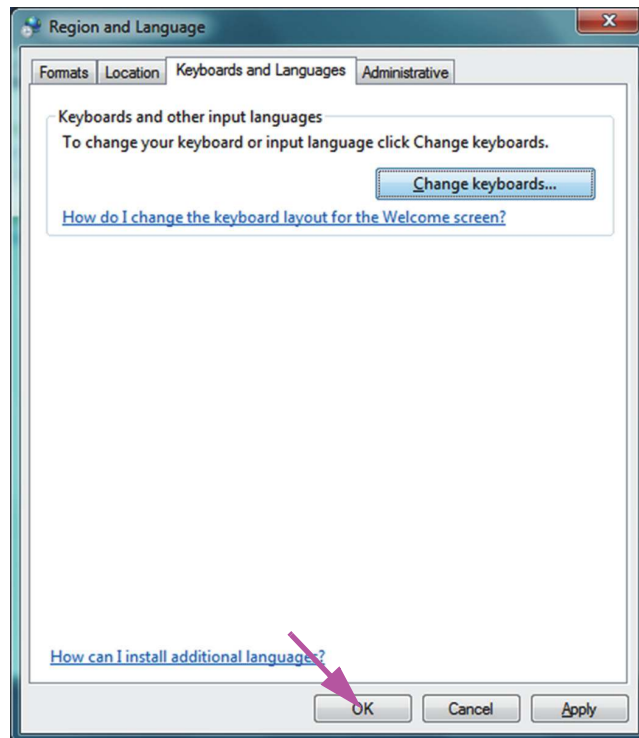

Figure C-12. Region and Language Screen—Keyboards and Languages Tab

9. Close the Control Panel window and log out of the computer.

C.4.3 Welcome Screen Keyboard Layout

- For a Windows 7 computer, perform the procedure below to configure the Welcome screen keyboard layout for a non-English keyboard.
- For a Windows 10 computer, no configuration is required.

Configuring the Windows 7 Welcome Screen Keyboard Layout

Perform this procedure to enable the switching of the configured keyboard layouts at the Windows 7 login screen.

1. Log in to Windows 7 as **Cepheid-Admin**, if not already logged in.
2. If the GeneXpert Dx software starts, exit the software.
3. Open the Control Panel, and then click **Clock, Language, and Region** (see [Figure C-13](#)).



Figure C-13. Control Panel Window

4. The Clock, Language, and Region window appears (see Figure C-14). Click **Region and Language**.

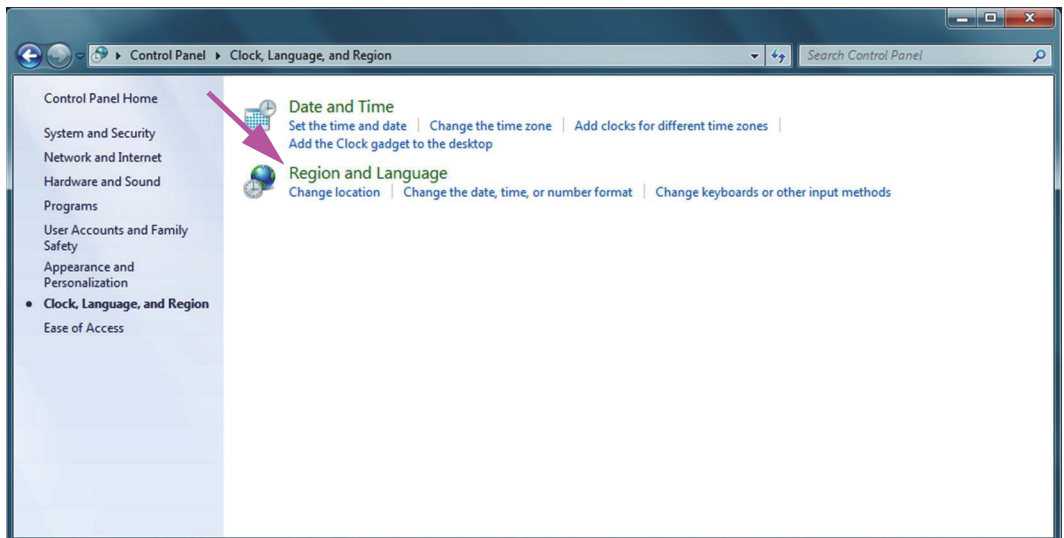

Figure C-14. Clock, Language, and Region Window

5. The Region and Language screen appears (see Figure C-15).

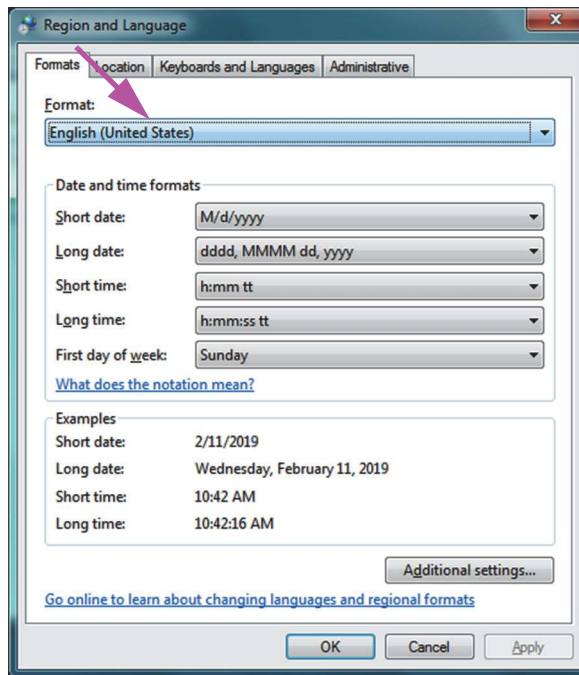

Figure C-15. Region and Language Drop-Down Window—Formats Tab

6. Click the **Administrative** tab. The Administrative tab appears (see Figure C-16).

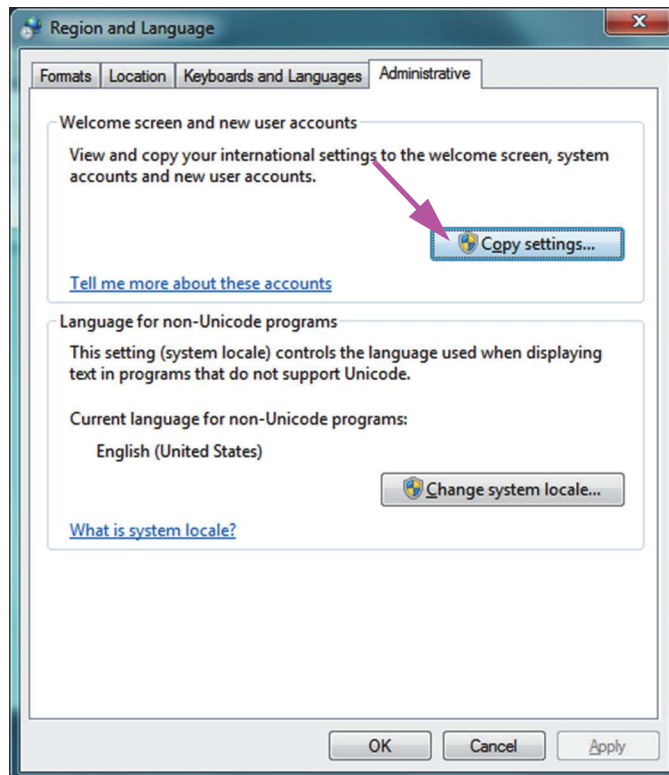

Figure C-16. Region and Language Screen—Administrative Tab

7. On the **Administrative** tab, click the **Copy settings...** button.

- The Welcome screen and new user account settings screen appears (see Figure C-17).

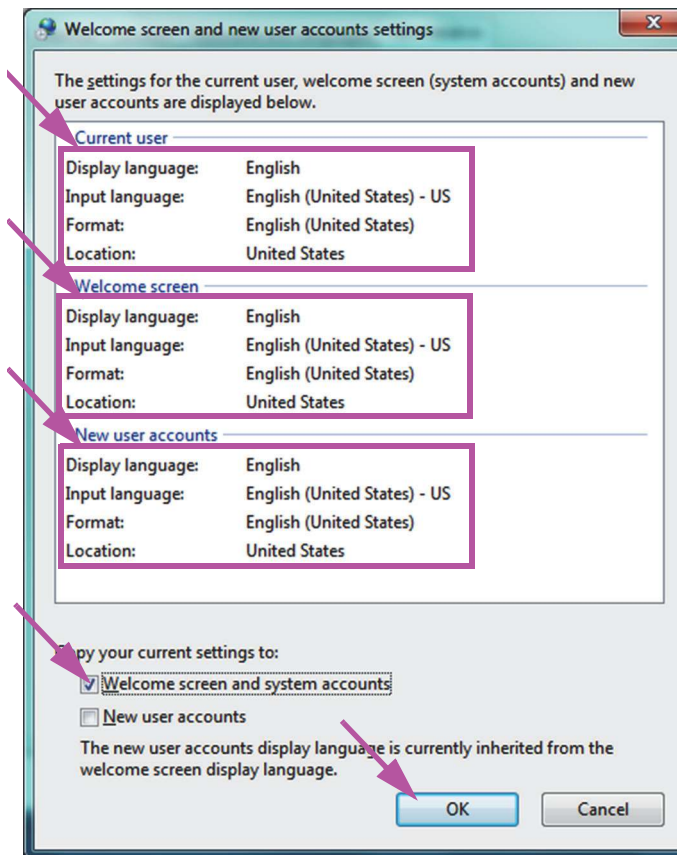

Figure C-17. Welcome Screen and New User Account Settings Screen

- Verify that the Format fields match the language selected in Section C.4.1, and the Input Language fields match the language selected in Section C.4.2 (see Figure C-17).
- Select the **Welcome screen and system accounts** check box.
- When you are finished, click the **OK** button. The Region and Languages window appears.
- Click the **OK** button to close the Region and Languages window.
- Close the Control Panel window.
- Restart the computer.

Note

The new settings will apply after you restart the computer.

C.4.4 Login Screen

- For Windows 7, see [Section C.4.4.1, Windows 7 Login Screen](#).
- For Windows 10, see [Section C.4.4.2, Windows 10 Login Screen](#).

C.4.4.1 Windows 7 Login Screen

1. When restarting the computer (after completing the language and keyboard additions), when the Windows 7 login screen appears there is now a **two-letter icon** in the upper left corner of the screen showing the current (active) keyboard layout. The active keyboard layout language can now be changed on this screen by clicking this **two-letter icon** (see [Figure C-18](#)).



Figure C-18. Windows 7 Login Screen Showing Two-Letter Country Designation

2. Click the two-letter icon and a menu similar to that shown at the left in [Figure C-19](#) appears.

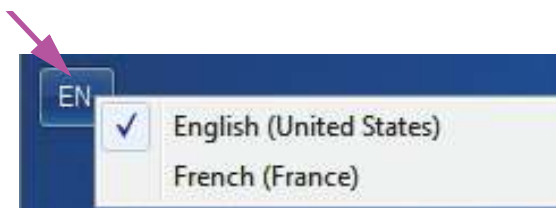

The language designation also appears on the task bar at the bottom of the screen after start-up. Moving the cursor over the letters displays the complete country/language name.



Figure C-19. Drop-Down Language Menu—Welcome Screen (Windows 7)

3. Click any of the languages displayed to change the language.

Note

Changes to the keyboard layout only applies at login, and does not affect the GeneXpert Dx software. If the icon does not exist, or the desired language is not available, perform the procedure in [Section C.4.1](#) to add the keyboard language.

This completes the Windows 7 configuration. Go to [Section C.5](#) to configure the barcode scanner.

C.4.4.2 Windows 10 Login Screen

1. When restarting the computer (after completing the language and keyboard additions), when the Windows 10 login screen appears there is now a **three-letter icon** in the lower right corner of the screen showing the current (active) keyboard layout. The active keyboard layout language can now be changed on this screen by clicking this **three-letter icon** (see [Figure C-20](#)).

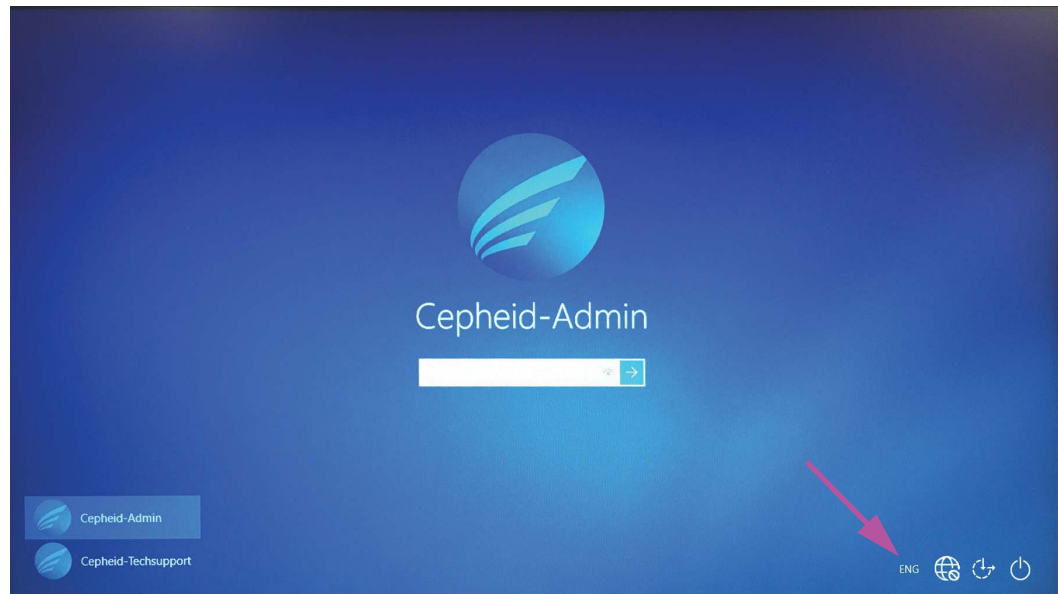
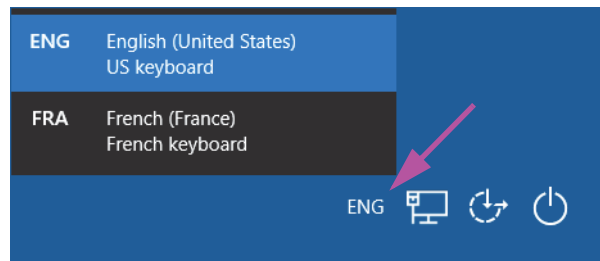

Figure C-20. Windows 10 Login Screen Showing Three-Letter Country Designation

2. Click the three-letter icon and a menu similar to that shown at the top in [Figure C-21](#) appears.



The language designation also appears on the task bar at the bottom of the screen after start-up. Moving the cursor over the letters displays the complete country/language name.

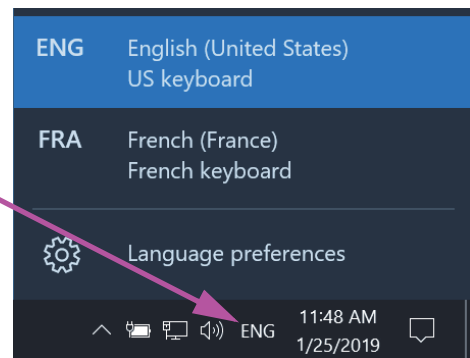

Figure C-21. Drop-Down Language Menu—Welcome Screen (Windows 10)

3. Click any of the languages displayed to change the language.

Note

Changes to the keyboard layout only applies at login, and does not affect the GeneXpert Dx software. If the icon does not exist, or the desired language is not available, perform the procedure in [Section C.4.1](#) to add the keyboard language.

This completes the Windows 10 configuration. Go to [Section C.5](#) to configure the barcode scanner.

C.5 Configuring and Testing the Barcode Scanner

The barcode scanner must be configured and tested. Depending on the scanner model, perform the procedure that matches your barcode scanner:

- Symbol, Model DS6708: [Section C.5.1, Configuring the Symbol Model DS6708 Scanner](#)
- Zebra Model DS4308-HC: [Section C.5.2, Configuring the Zebra Model DS4308-HC Scanner](#)

C.5.1 Configuring the Symbol Model DS6708 Scanner

1. Verify the manufacturer and model of the scanner. The scanner must be a Symbol, Model DS6708 scanner to use this procedure. This scanner is gray with a yellow scan button.

Note

The barcode scanner must be a Symbol (brand), Model DS6708 in order to support the internationalized inputs shown below. If the scanner is a Zebra DS4308-HC scanner, see [Section C.5.2, Configuring the Zebra Model DS4308-HC Scanner](#).

2. Plug the barcode scanner into an available USB port and wait for it to initialize (there will be a series of beeps).
3. Configure the barcode scanner by scanning the barcodes shown in [Figure C-22](#) through [Figure C-26](#), in order:



Figure C-22. Barcode 1: *HID Keyboard Emulation



Figure C-23. Barcode 2: *North American Standard USB Keyboard



Figure C-24. Barcode 3: Enable Keypad Emulation



Figure C-25. Barcode 4: Enable Keypad Emulation with Leading Zero



Figure C-26. Barcode 5: Enable

4. Test the scanner by following the procedure in [Section C.5.3, Testing the Configuration](#).

C.5.2 Configuring the Zebra Model DS4308-HC Scanner

1. Verify the manufacturer and model of the scanner. The scanner must be a Zebra Model DS4308-HC scanner to use this procedure. This scanner is white and gray with a blue scan button.

Note

The barcode scanner must be a Zebra, Model DS4308-HC in order to support the internationalized inputs shown below. If the scanner is a Symbol DS6708 scanner, [Step 2](#) see [Section C.5.1, Configuring the Symbol Model DS6708 Scanner](#). If the scanner is a JDK-2201 scanner, see [Section C.5.2, Configuring the Zebra Model DS4308-HC Scanner](#).

2. Plug the barcode scanner into an available USB port and wait for it to initialize (there will be a series of beeps).
3. Configure the barcode scanner for international configuration by scanning the barcode shown in [Figure C-27](#).



Figure C-27. International Configuration Barcode

4. Test the scanner by following the procedure in [Section C.5.3, Testing the Configuration](#).

If it is necessary to configure the barcode scanner back to the North American barcode configuration, scan the barcode shown in [Figure C-28](#).



Figure C-28. North American Configuration Barcode

C.5.3 Testing the Configuration

To test that the configuration was successful, launch the GeneXpert Dx software. Verify each language using the barcodes below:

Note

If any barcodes do not scan correctly, unplug the barcode scanner from the computer and repeat the configuration procedure starting with [Step 2 in Section C.5.1](#) or [Step 2 in Section C.5.2](#) and rescan the barcodes shown in [Figure C-22](#) through [Figure C-26](#).

French

Go to the Create Test screen and scan the barcode shown in [Figure C-29](#) when prompted to scan the Sample ID:



Figure C-29. French Sample Barcode

Verify that the Sample ID field is filled in with the string: ÀâÆæçÉÈ êËÏîðŒœ.

Italian

Go to the Create Test screen and scan the barcode shown in [Figure C-30](#) when prompted to scan the Sample ID:



Figure C-30. Italian Sample Barcode

Verify that the Sample ID field is filled in with the string: àèèíîòóúú.

German

Go to the Create Test screen and scan the barcode shown in [Figure C-31](#) when prompted to scan the Sample ID:



Figure C-31. German Sample Barcode

Verify that the Sample ID field is filled in with the string: ÄÖßÜ.

Portuguese

Go to the Create Test screen and scan the barcode shown in [Figure C-32](#) when prompted to scan the Sample ID:



Figure C-32. Portuguese Sample Barcode

Verify that the Sample ID field is filled in with the string: áâêçêêêéóçãú.

Spanish

Go to the Create Test screen and scan the barcode shown in [Figure C-33](#) when prompted to scan the Sample ID:



Figure C-33. Spanish Sample Barcode

Verify that the Sample ID field is filled in with the string: ñüñchllñrr.

Chinese

Go to the Create Test screen and scan the barcode shown in [Figure C-34](#) when prompted to scan the Sample ID:



Figure C-34. Chinese Sample Barcode

Verify that the Sample ID field is filled in with the string: 男孩和女孩 .

Russian

Go to the Create Test screen and scan the barcode shown in [Figure C-35](#) when prompted to scan the Sample ID:



Figure C-35. Russian Sample Barcode

Verify that the Sample ID field is filled in with the string: мальчиков и девочек .

Japanese

Go to the Create Test screen and scan the barcode shown in [Figure C-36](#) when prompted to scan the Sample ID:



Figure C-36. Japanese Sample Barcode

Verify that the Sample ID field is filled in with the string:

ういうくすつぬふむゆるえけせてねへめれうえ・

C.6 Date and Time Format

The date and time format used by the GeneXpert Dx software is configured in the System Configuration screen. See [Section 2.9.2, Local Date and Time](#) for details.

D Apache OpenOffice (AOO) Initial Configuration Instructions

D.1 Introduction

Apache Open Office (AOO) is an open source solution replacing Microsoft Office on Cepheid customer computers, and is used for viewing, formatting and storing .csv files.

On initial startup, the program must be configured for proper display of the .csv files. This appendix provides instructions for the opening and configuration of .csv files generated on GeneXpert using AOO on your system.

Note

For GeneXpert Dx systems using software versions prior to November 30, 2015, Microsoft Excel (part of Microsoft Office software) is used for displaying .csv files, and no configuration is necessary for that software. If you need assistance, see the [Technical Assistance](#) section in the [Preface](#) for contact information.

D.2 Configuration

1. In the GeneXpert folder on your system, navigate to the **Export** folder. Right click on the .csv file you want to open. When the drop-down menu appears, click **Open with** and select **OpenOffice Calc**. See [Figure D-1](#).

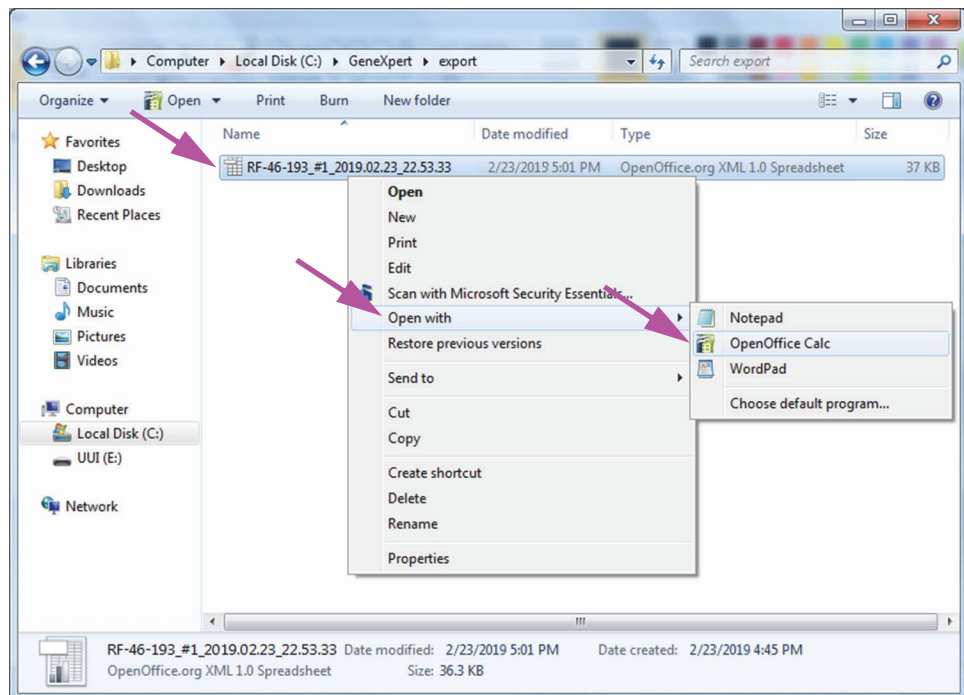

Figure D-1. Opening a .csv File to Configure AOO (Example)

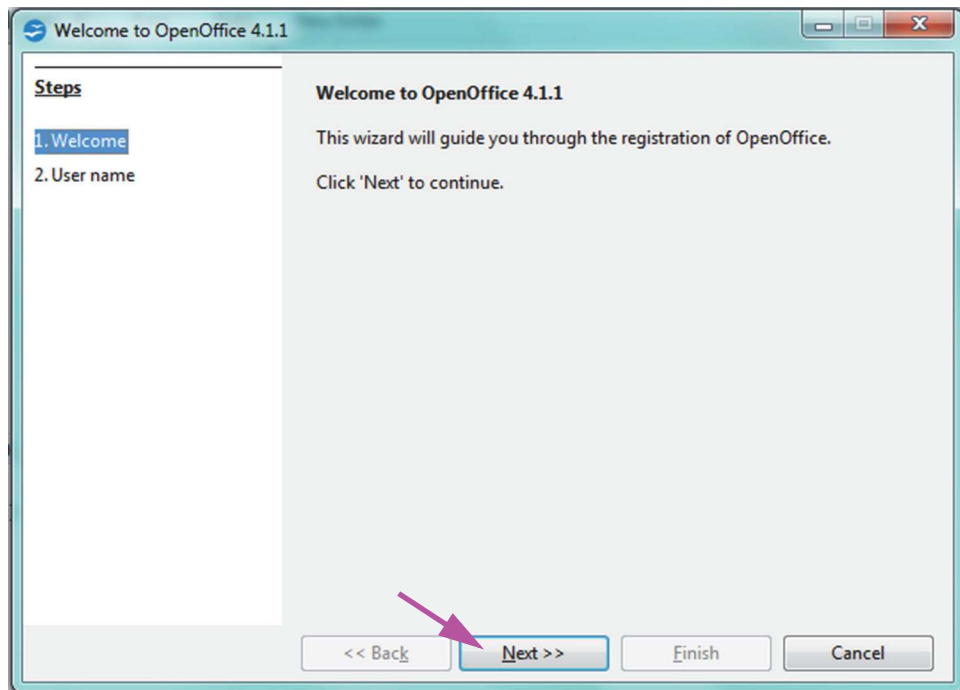

Figure D-2. AOO Registration Screen

2. On initial startup of AOO, a registration screen will appear. See [Figure D-2](#).
3. Click **Next**. When the new screen appears, enter the requested information (name and initials), and click **Finish**. The Text Import screen will appear. See [Figure D-3](#).

In the **Character Set** drop-down menu:

For single-byte languages (English, French, Spanish, Portuguese, Italian, German, Russian) select **Unicode (UTF-8)**.

For multi-byte languages (Japanese and Chinese) select **Unicode**.

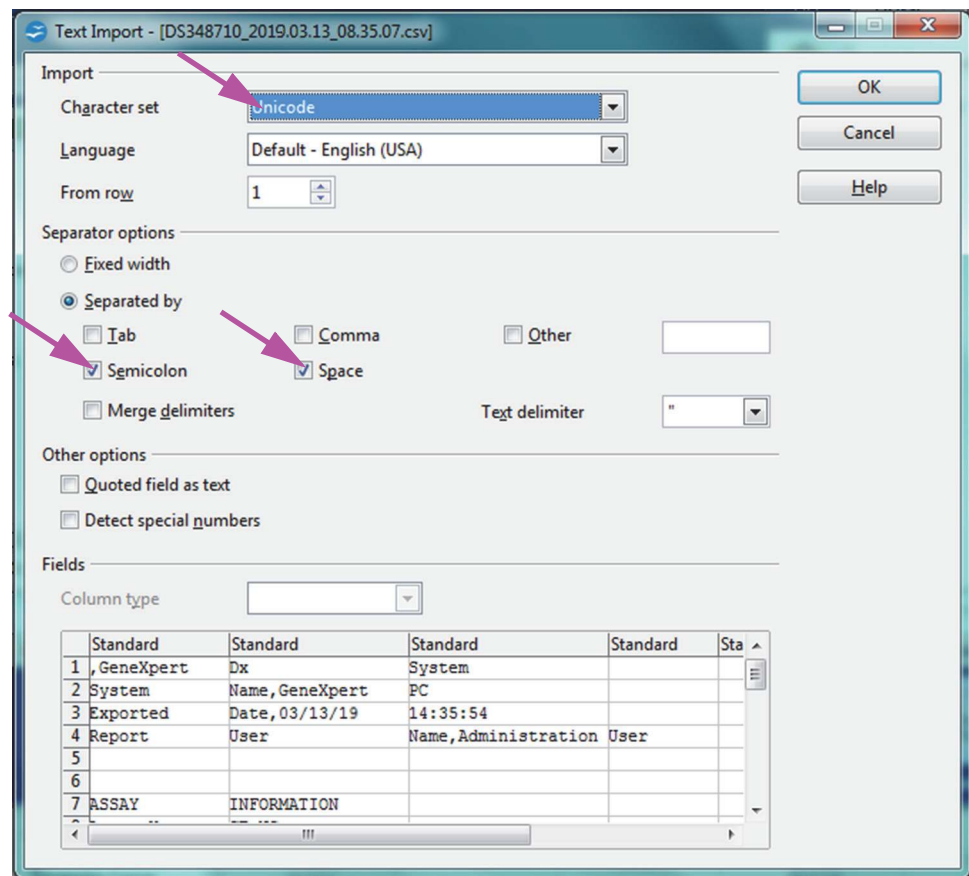

Figure D-3. Text Import Screen, showing Default Settings

4. On the default Text Import screen (see [Figure D-3](#)), uncheck **Semicolon** and **Space**.
5. Select the checkbox to the left of **Comma** and **Quoted field as text**. See [Figure D-4](#).

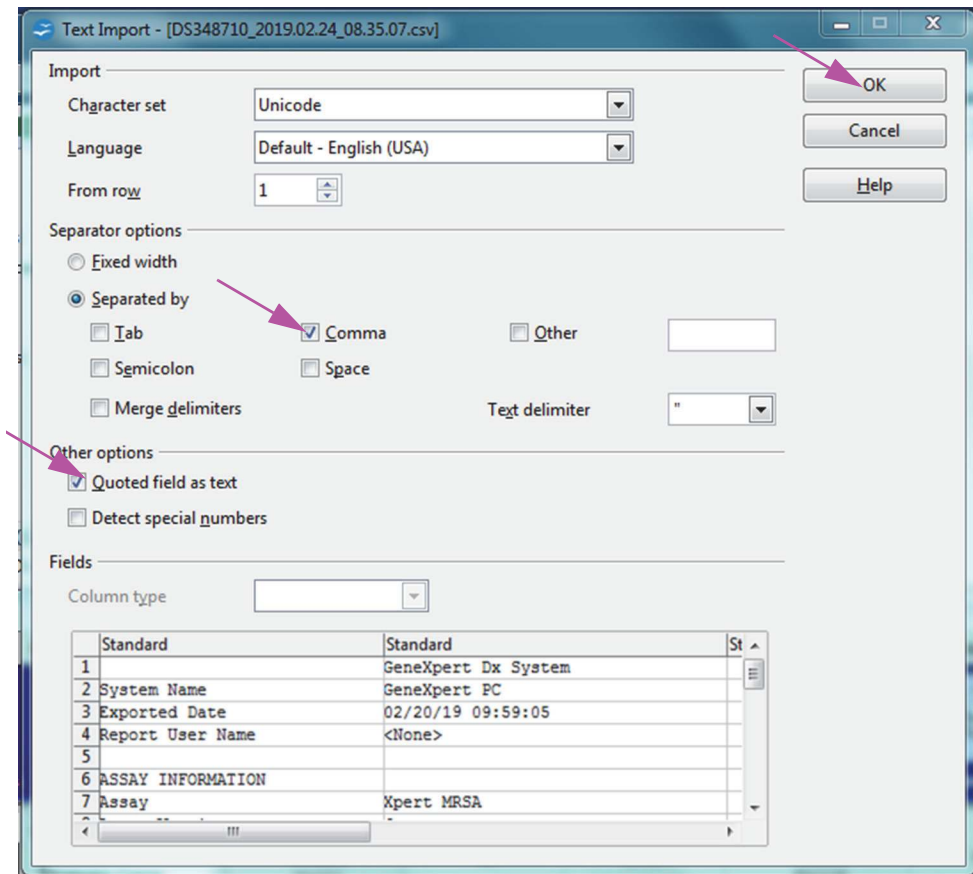

Figure D-4. Text Import Screen with New Settings Selected

6. After making selections, click **OK**. The .csv file will be displayed. See [Figure D-5](#).
7. Once the file is open, click on the upper left corner of the worksheet to highlight all the cells, as shown in [Figure D-5](#).

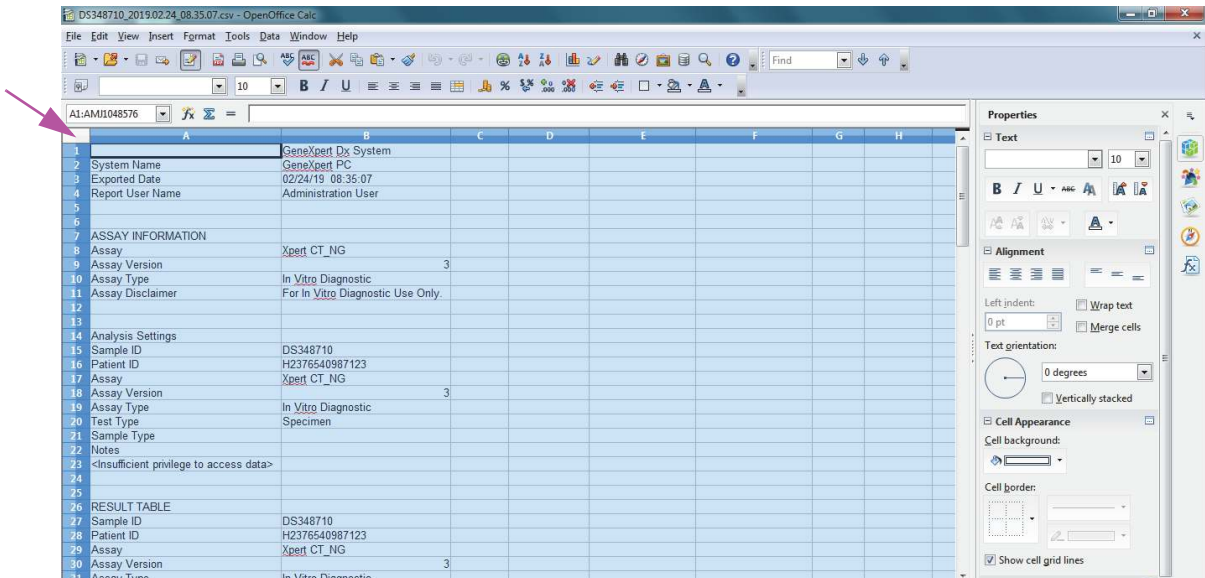

Figure D-5. All Cells Selected

8. Right click on the column header. A drop-down menu will appear at the right of the column (see Figure D-6).
9. In this drop-down menu, select **Column Width**.

Right-Click in Column Header

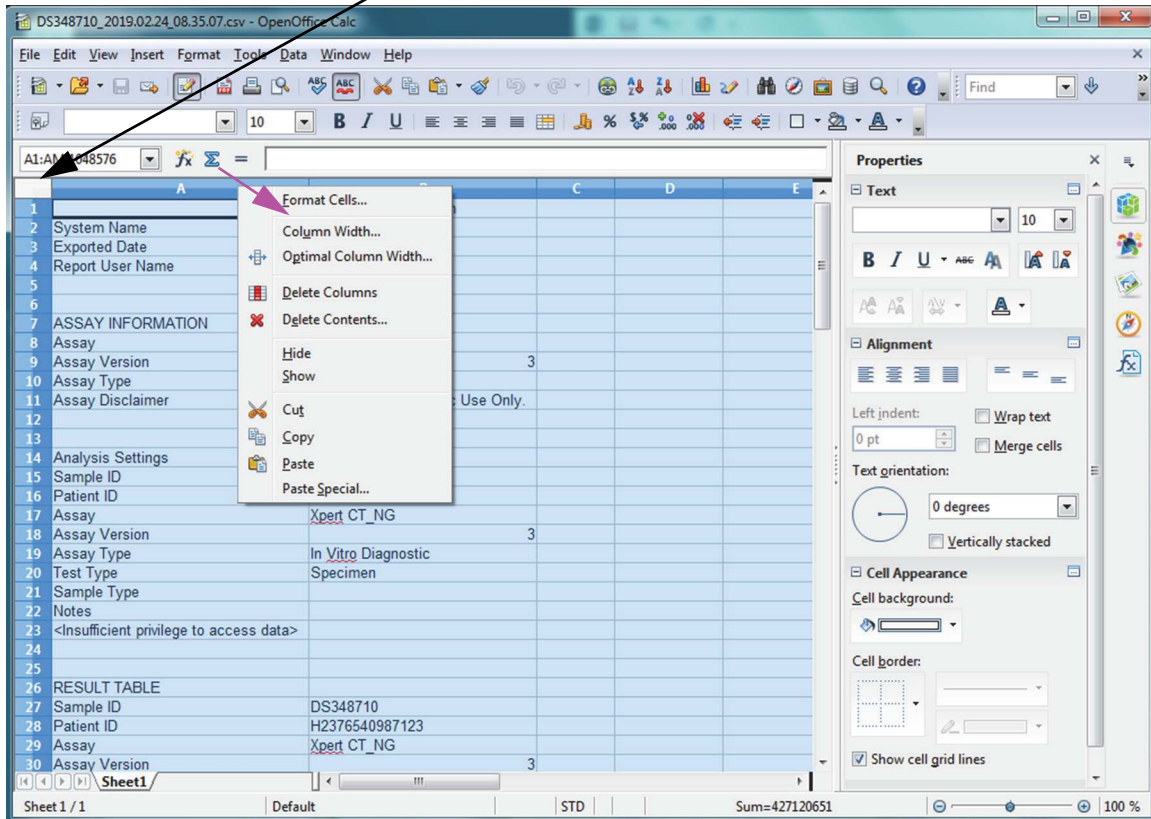

Figure D-6. Drop-Down Menu to Select Column Width

- 10. The Column Width dialog box appears. See Figure D-7

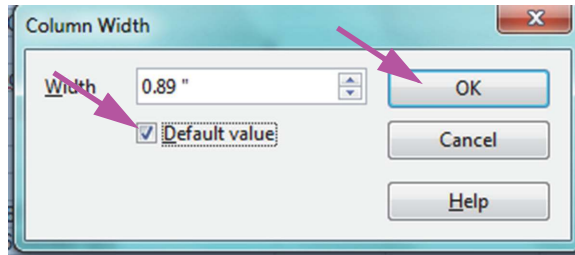

Figure D-7. Column Width Dialog Box

- 11. Click the checkbox to the left of **Default value**, and then click **OK** to close the dialog box. The column widths will then adjust and the file will be formatted, as shown in Figure D-8. Click anywhere in the blank columns to “deselect” the blue cells and turn the cells white again.

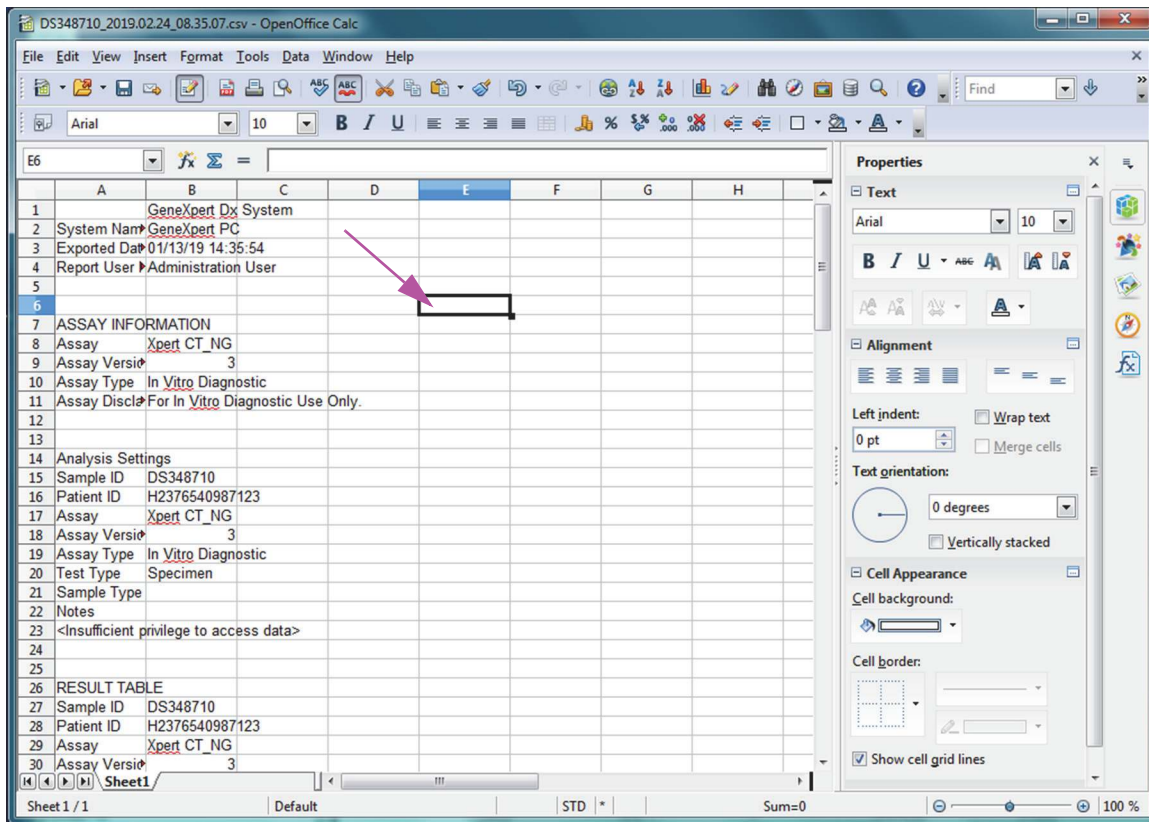

Figure D-8. Final View of File with Columns Adjusted

- 12. Click **Save** under the **File** menu to save the document.

The document saving format screen shown in Figure D-9 may appear. If so, click **Keep Current Format**, and the dialog box will close.

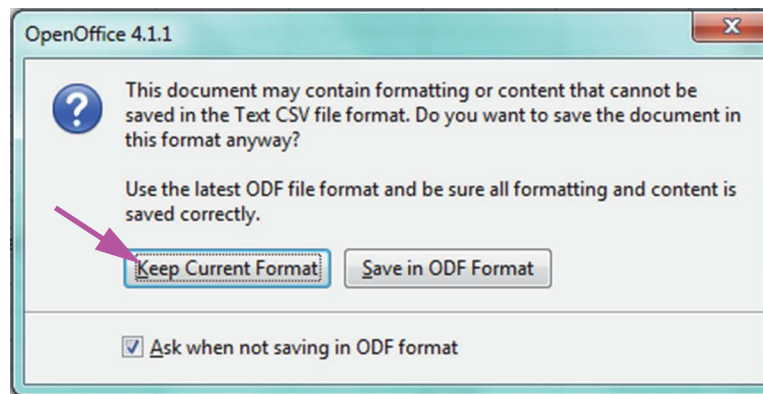

Figure D-9. Format Saving Dialog Box

13. This completes the configuration set-up for the initial .csv file.

For all subsequent .csv files no setup will be required, and it will only be necessary to acknowledge the existing setting chosen in this procedure.

